

Digital HD Video Camera Recorder

Operating Guide

Table of Contents	
Getting Started	
Recording	
Playback	
Editing	
Using the Menu	
Connecting with another device	
Troubleshooting	
Additional Information	

NXCAM

AVCHD
Progressive



InfoLITHIUM L
SERIES

MEMORY STICK™

XC
CLASS C

HDMI™
HIGH DEFINITION MULTIMEDIA INTERFACE



Read this first

Before operating this unit, please read this manual thoroughly, and retain it for future reference.

Notes on use

Using the camcorder

- Do not hold the camcorder by the following parts, and also do not hold the camcorder by the jack covers.

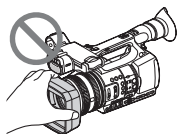

Lens hood with lens cover

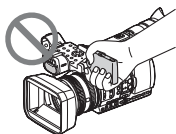

LCD screen

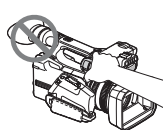

Microphone (sold separately) or Microphone holder

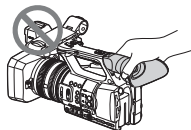

Viewfinder

Notes

- The camcorder is not dustproof, dripproof or waterproof. See "About handling of your camcorder" (p. 122).
- When connecting the camcorder to another device with communication cables, be sure to insert the connector plug in the correct way. Pushing the plug forcibly into the terminal will damage the terminal and may result in a malfunction of the camcorder.
- Use the camcorder in accordance with the regulations of a place where you use it.

On the LCD screen and lens

- A menu item that is grayed out is not available under the current recording or playback conditions.

- The LCD screen is manufactured using extremely high-precision technology, so over 99.99% of the pixels are operational for effective use. However, there may be some tiny black points and/or bright points (white, red, blue, or green in color) that appear constantly on the LCD screen. These points are normal results of the manufacturing process and do not affect the recording in any way.

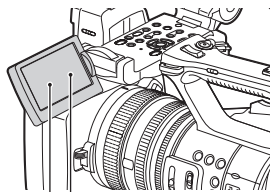

White, red, blue or green point
Black point

On sunlight

- Do not record the sun or leave the camcorder under the sun for a long time. The internal parts of the camcorder may be damaged. If sunlight is focused on a nearby object, it may cause a fire.
- Do not expose your camcorder's viewfinder, lens, or LCD screen to the sun or strong light source for extended periods. Doing so may cause a malfunction of the camcorder.
- Do not attempt to record the sun directly. Doing so may cause a malfunction of the camcorder.

On the temperature of your camcorder and battery pack

Your camcorder has a protective function that disables recording or playback if the temperature of your camcorder or battery pack is beyond the safely operable range. In this case, a message appears on the LCD screen or in the viewfinder (p. 112).

On recording

- In order to stabilize memory card operation, it is recommended that you format the memory card when you use it with your camcorder for the first time. All data recorded on the memory card will be erased by formatting, and cannot be recovered. Save important data on the memory card on other media such as a computer, before formatting the memory card.
- Before starting to record, test the recording function to make sure the picture and sound are recorded without any problems.
- Compensation for the loss of the content of recordings or the loss of recording opportunities cannot be provided, even if recording or playback is not possible due to a malfunction of the camcorder, storage media, etc., or even if images or sounds are distorted due to the limits of the capabilities of the camcorder.
- TV color systems differ depending on the countries/regions. To view your recordings on a TV, a TV of the appropriate color system for the country/region is required.
- Television programs, films, video tapes, and other materials may be copyrighted. Unauthorized recording of such materials may be contrary to the copyright laws.
- Because of the way that the image device (CMOS sensor) reads out image signals, the following phenomena may occur.
 - The subjects passing by the frame rapidly might appear crooked depending on the recording conditions. (This phenomenon may be notable in displays having high motion resolution.)
 - Horizontal lines appear on the LCD screen during recording under fluorescent lights, sodium lamps or mercury lamps. The phenomena can be reduced by adjusting the shutter speed (p. 39).

DVD media recorded with high definition image quality (HD)

DVD media recorded with high definition image quality (HD) can be played back with devices that are compatible with the AVCHD format. You cannot play discs recorded with high definition image quality (HD) with DVD players/recorders as they are not compatible with the AVCHD format. If you insert a disc recorded with the AVCHD format (high definition image quality (HD)) into a DVD player/recorder, you may not be able to eject the disc.

Save all your recorded image data

- To prevent your image data from being lost, save all your recorded images on external media periodically. To save images on an external device, see page 102.
- Movies recorded with the recording mode set to PS or FX on [**HD**] REC FORMAT] can be saved on an external media device and Blu-ray disc only (p. 102).

To handle the recorded images on your computer

Download the “Content Browser” software (p. 17).

Format the recording media using [MEDIA FORMAT] if images are not recorded or played back properly

If you continue recording and deleting images on recording media for a long period of time, the files on that recording media may be fragmented. As a result, you may not be able to record and save images properly. If this happens, save images on a separate recordable media, such as a disc or computer, then format the recording media (p. 78).

Read this first (Continued)

About the operation of the camcorder

You can operate the camcorder using the SEL/PUSH EXEC dial (p. 23, 81), ▲/▼/◀/▶/EXEC buttons (p. 81), and the touch panel. However, you cannot use the touch panel* to make some settings such as the MENU items.

* Some operations are possible only with the touch panel.

About this manual

- The on-screen displays in each local language are used for illustrating the operating procedures. Change the screen language before using your camcorder if necessary (p. 23).
- Design and specifications of recording media and other accessories are subject to change without notice.
- The screen displays used in this manual are those of the PAL model.
See the bottom of the camcorder to confirm whether it is NTSC or PAL system.

Identifying parts and controls

Body

The numbers in () are reference pages.

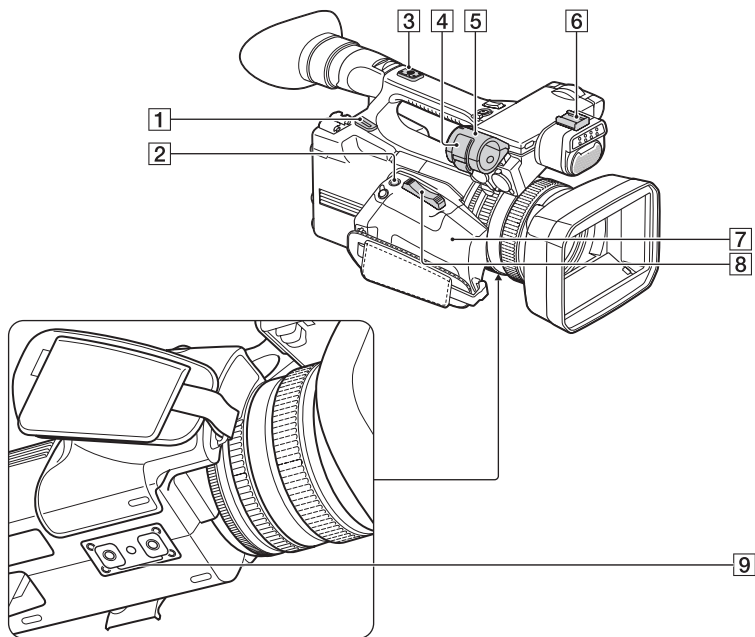

- 1** Hook for shoulder strap
- 2** ASSIGN 6/FOCUS MAGNIFIER button (62)
- 3** Accessory shoe receptacles (22)
- 4** Microphone fixing clamber
- 5** Microphone holder
- 6** Accessory shoe
- 7**  (N mark)
 - Touch the mark when you connect the camcorder to a smartphone equipped with the NFC function.
 - NFC (Near Field Communication) is an international standard of the short-range wireless communication technology.
- 8** Zoom lever
- 9** Tripod receptacles
 - For 1/4-20UNC screws
 - For attaching a tripod with a screw shorter than 5.5 mm (sold separately).
 - It may not be possible to attach a tripod in the proper direction, depending on its specification.

Identifying parts and controls (Continued)

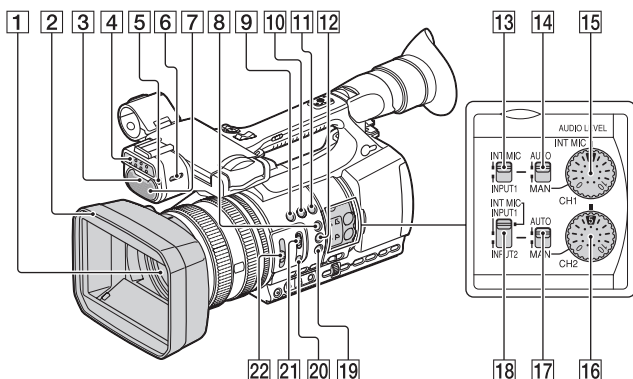

1 Lens (21)

2 Lens hood with lens cover (21)

3 Front recording lamp (100)

The recording lamp flashes if the remaining capacity of recording media or battery is low.

4 Video light (45)

5 Remote sensor (100)

6 Video light switch (45)

7 Built-in microphone

8 ASSIGN 1/PEAKING button (62)

9 ASSIGN 3/IRIS PUSH AUTO button (38)

10 ASSIGN 4/LAST SCENE button* (62)

11 ASSIGN 5/ZEBRA button (62)

12 ASSIGN 2/HISTOGRAM button (62)

13 CH1 (INT MIC/INPUT 1) switch (43)

14 AUTO/MAN (CH1) switch (43)

15 AUDIO LEVEL (CH1) dial (43)

16 AUDIO LEVEL (CH2) dial (43)

17 AUTO/MAN (CH2) switch (43)

18 CH2 (INT MIC/INPUT 1/INPUT 2) switch (43)

19 S&Q button (60)

20 PUSH AUTO/FOCUS HOLD button (32)

21 FOCUS switch (32)

22 ND FILTER switch (40)

* ASSIGN 4/LAST SCENE button and ASSIGN 2/HISTOGRAM button have raised tactile dots for your convenience in locating the buttons.

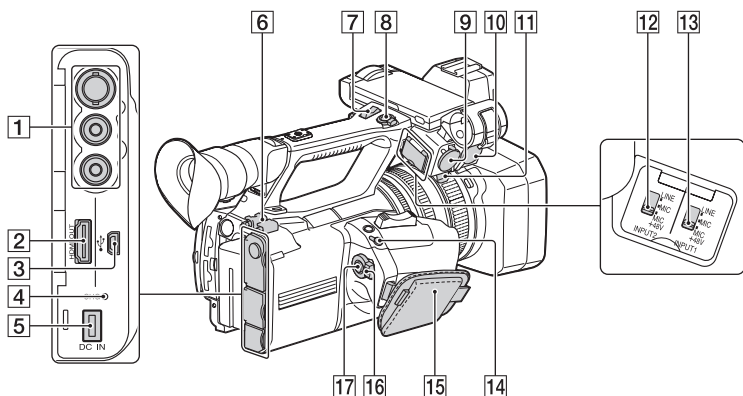

- 1** VIDEO OUT/AUDIO OUT jacks (71, 104)
- 2** HDMI OUT jack (71)
- 3** Ψ (USB) jack (102)
- 4** CHG lamp
- 5** DC IN jack (18)
- 6** Cable clamp
- 7** Handle zoom lever (31)
- 8** Handle record button (27)
- 9** INPUT 2 jack
- 10** INPUT 1 jack (20)
- 11** Cable holder (20)
- 12** INPUT 2 switch (43)
- 13** INPUT 1 switch (43)
- 14** REMOTE jack
The REMOTE jack is used for controlling playback, etc. on the video device and peripherals connected to it.
- 15** Grip belt
- 16** POWER switch (22)
- 17** Record button (27)

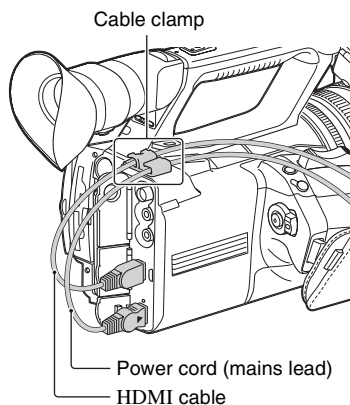

About the cable clamp

The cable clamp provides a more secure connection for the power cord (mains lead) or HDMI cable. However, some HDMI cables may not fit properly in the clamp.

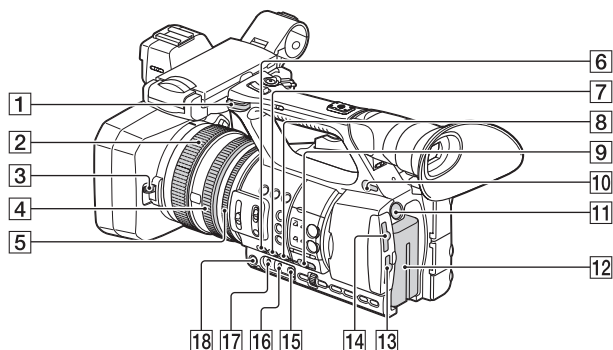

Identifying parts and controls (Continued)



- 1 Hook for shoulder strap
- 2 Focus ring (32)
- 3 Lens cover lever (21)
- 4 Zoom ring (31)
- 5 Iris ring (38)
- 6 GAIN button (39)
- 7 WHT BAL button* (41)
- 8 SHUTTER SPEED button (39)
- 9 AUTO/MANUAL switch (38)
- 10  (headphones) jack
For connecting stereo mini-jack headphones.
- 11 BATT RELEASE button (19)
- 12 Battery pack (18)
- 13 Memory card B slot/select button/access lamp (25)
- 14 Memory card A slot/select button/access lamp (25)
- 15  (one push) button (41)
- 16 White balance memory switch (41)
- 17 Gain switch (39)
- 18 IRIS button* (38)

To attach a shoulder strap

Attach a shoulder strap (sold separately) to the hooks for a shoulder strap.

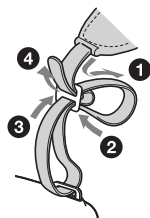

* IRIS button and WHT BAL button have raised tactile dots for your convenience in locating the buttons.

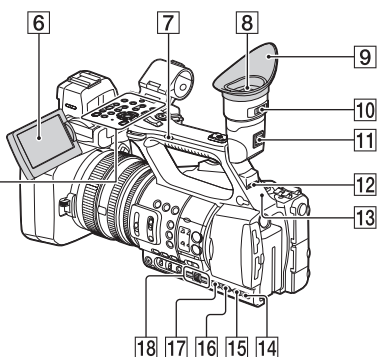
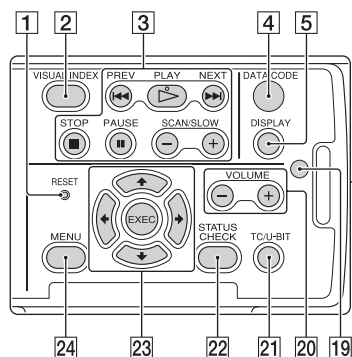

1 RESET button

If you press the RESET button, all settings including the clock setting (except the picture profile settings) return to the default.

2 VISUAL INDEX button (64)

3 Playback control buttons (PREV, PLAY*, NEXT, STOP, PAUSE, SCAN/SLOW) (64)

4 DATA CODE button (69)

5 DISPLAY button (69)

6 LCD screen/touch panel (24)

7 Handle zoom switch (31)

8 Viewfinder (24)

9 Large eyecup (24)

10 Viewfinder lens adjustment lever (24)

11 Viewfinder release lever (124)

12 HEADPHONE MONITOR switch (45)

13 Rear recording lamp (100)

The recording lamp flashes if the remaining capacity of recording media or battery is low.

14 STATUS CHECK button (70)

15 PICTURE PROFILE button (53)

16 DISPLAY button (69)

17 MENU button** (23, 81)

18 SEL/PUSH EXEC dial/↔/↔ button (23, 81)

19 Illuminance sensor

20 VOLUME buttons* (64)

21 TC/U-BIT button

Switches between time code and user bit to display on the LCD screen.

22 STATUS CHECK button (70)

23 ↕/↔/↔/↔/EXEC buttons (81)

24 MENU button (23, 81)

* The right side of the VOLUME+ button, and PLAY button have raised tactile dots for easy button location.

**MENU button has a raised tactile bar for your convenience in locating the buttons.

Wireless Remote Commander

Remove the insulation sheet before using the Wireless Remote Commander.

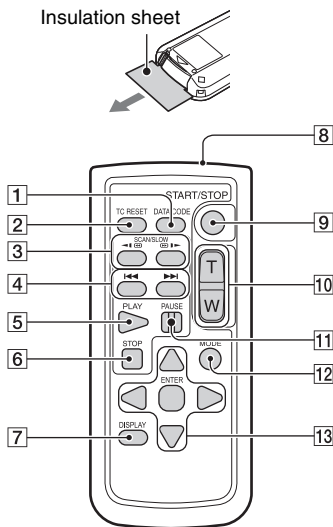

- 1 DATA CODE button (69)
- 2 TC RESET button (59)
- 3 SCAN/SLOW buttons (64)
- 4 ◀▶ (PREV/NEXT) buttons (64)
- 5 PLAY button (64)
- 6 STOP button (64)
- 7 DISPLAY button (69)
- 8 Transmitter
- 9 START/STOP button (27)
- 10 Power zoom lever
- 11 PAUSE button (64)
- 12 MODE button
- 13 ◀/▶/▲/▼/ENTER buttons

Notes

- Aim the Wireless Remote Commander towards the remote sensor to operate your camcorder.

- Point the remote sensor away from strong light sources such as direct sunlight or overhead lighting. Otherwise, the Wireless Remote Commander may not function properly.
- When you are operating with the Wireless Remote Commander supplied with your camcorder, your video device may also operate. In that case, select a commander mode other than DVD2 for your video device, or cover the sensor of your video device with black paper.

To change the battery of the Wireless Remote Commander

- 1 While pressing on the tab, inset your fingernail into the slit to pull out the battery case.
- 2 Place a new battery with the + side facing up.
- 3 Insert the battery case back into the Wireless Remote Commander until it clicks.

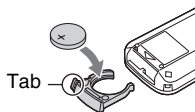

WARNING

Battery may explode if mistreated. Do not recharge, disassemble or dispose of in fire.

- When the lithium battery becomes weak, the operating distance of the Wireless Remote Commander may shorten, or the Wireless Remote Commander may not function properly. In this case, replace the battery with a Sony CR2025 lithium battery. Use of another battery may present a risk of fire or explosion.

Screen indicators

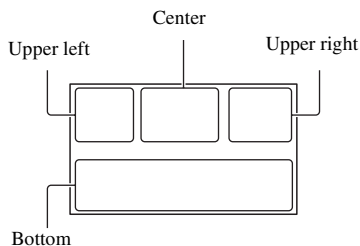

Upper left

Indicator	Meaning
100%	Remaining battery
	INTELLIGENT AUTO (face detection/scene detection/camera-shake detection) (46)
	SCENE SELECTION (47)
	REC FORMAT (35) (NTSC model)
	(PAL model)
	WIDE REC (89)
	Image size
	Optical zoom
	Clear image zoom
	Digital zoom
	ND filter (40)
	AIRPLANE MODE (98)
	SIMUL/RELAY REC
	NFC active
100-0001	Playback folder of memory card

Center

Indicator	Meaning
	Vibration warning

Indicator	Meaning
	Recording media
REC STBY	Recording status (27)
	Warning (112)
	Playback indicator (64)
	Processing
	Relay recording



Upper right

Indicator	Meaning
Omin	Estimated remaining recording time
	Recording/playback media
00:00:00:00	Time code (hour:minute:second:frame)

Bottom

Indicator	Meaning
	Face detection [ON]
PEAKING	PEAKING (93)
	ZEBRA (93)
	STEADYSHOT (87)
	Manual focus (32)
	Picture profile (53)
F3.5	Iris (38)
9dB	Gain (39)
100 180°	Shutter speed (39)
	Manual volume control (44)
LPCM	AUDIO FORMAT (91)
-2.0EV	AE SHIFT (87)
	Auto setting/manual setting (95)

Screen indicators (Continued)

Indicator	Meaning
	White balance (41)
	HISTOGRAM (93)
	AUDIO LEVEL DISPLAY (95)

Tips

- Indicators may look different or appear at different positions.

Data code during recording

The recording date, time and condition are recorded automatically on the recording media. They are not displayed while recording. However, you can check them by pressing the DATA CODE button (p. 69).

Table of Contents

Read this first	2
Identifying parts and controls	5
Body	5
Wireless Remote Commander	10
Screen indicators	11

Getting Started

Step 1: Checking supplied accessories	17
Step 2: Charging the battery pack	18
Step 3: Attaching the microphone and the lens hood with lens cover	20
Step 4: Attaching the accessory shoe	22
Step 5: Turning on the camcorder and setting the date and time	22
Setting the date and time	23
Changing the language setting	23
Step 6: Adjusting the LCD screen and viewfinder	24
Step 7: Preparing the recording media	25

Recording

Recording	27
Recording movies	27
Changing the setting of the record button/handle record button	29
Adjusting the zoom	31
Adjusting the focus	32
Using automatic focus/fixed focus temporarily (Push auto focus/Focus hold)	32
Using the expanded focus (Expanded focus)	33
Focusing on a distant subject (Focus infinity)	33
Focusing by touching the LCD screen (Spot focus)	33
Focusing on a detected face (Face detection)	34
Changing the recording setting	35
Selecting the recording format for high definition image quality (HD)	35
Recording MP4 movies	36
Setting the DV MODE (DV mode)	36
Adjusting the brightness	38
Adjusting the iris	38
Adjusting the gain	39
Adjusting the shutter speed	39
Adjusting the exposure	40
Adjusting the volume of light (ND filter)	40
Adjusting the color tone	41
Adjusting the white balance	41

Table of Contents (Continued)

Audio setup	43
Using the internal microphone	43
Recording sound from an external audio device	43
Adjusting the volume.....	44
Setting the headphone sound	45
Useful functions	45
Recording in dim places (Video light).....	45
Selecting the suitable setting automatically for the recording situation (AUTO MODE setting)	46
What you can do with the Wi-Fi function of the camcorder.....	47
Downloading "PlayMemories Mobile"	48
Connecting the camcorder to an Android smartphone equipped with the NFC function using One-touch.....	48
Using a smartphone as a remote controller.....	49
Transferring images to a smartphone	50
Connecting without using the NFC function (Android).....	51
Connecting without using the NFC function (iPhone/iPad)	52
Customizing the picture quality (Picture profile)	53
Setting time data	59
Recording with the Slow & Quick Motion function	60
Reviewing the most recently recorded scene (Last Scene Review).....	61
Assigning the functions to the ASSIGN buttons	62

Playback









Playback	64
Playing back movies	64
Playing back still images.....	67
Changing/checking the settings in your camcorder	69
Changing the screen display	69
Displaying recording data (Data code).....	69
Checking the settings in your camcorder (Status check).....	70
Connecting a monitor or a TV	71

Editing

Protecting movies and still images (Protect)	74
Dividing a movie	74
Deleting movies and still images	75
Copying movies and still images	76
Capturing still images from a movie	77
Formatting the recording media	78
Preventing data on recording media from being recovered	79

Repairing the image database file	80
---	----

Using the Menu

Operating the menu	81
Menu items	83
 (CAMERA SET) menu	86
Settings to adjust your camcorder to the recording conditions (GAIN SET/ STEADYSHOT, etc.)	
 (REC/OUT SET) menu	89
Recording settings, input and output settings (REC SET/VIDEO OUT, etc.)	
 (AUDIO SET) menu	91
Settings for the audio recording ( AUDIO FORMAT/XLR SET, etc.)	
 (DISPLAY SET) menu	93
Display settings (MARKER/DISPLAY OUTPUT, etc.)	
 (TC/UB SET) menu	97
Time code settings (TC PRESET/UB PRESET/TC FORMAT, etc.)	
 (NETWORK SET) menu	98
Settings for the Wi-Fi function (SEND TO SMARTPHONE/CTRL W/ SMARTPHONE, etc.)	
 (OTHERS) menu	99
Settings while recording or other basic settings (AREA SET/BEEP, etc.)	

Connecting with another device

Saving images on an external media device	102
Creating a standard definition image quality (DV) disc with a recorder, etc.	104

Troubleshooting

Troubleshooting	105
Warning indicators and messages	112

Additional Information

Recording time of movies and the number of recordable photos	115
Using your camcorder abroad	117
File/folder structure on the recording media	118

Table of Contents (Continued)

Maintenance and precautions	119
About the AVCHD format	119
About the memory card.....	119
About the "InfoLITHIUM" battery pack.....	120
About handling of your camcorder	122
Specifications	125
Index	130

Step 1: Checking supplied accessories

Make sure that you have following items supplied with your camcorder.

The number in the parentheses indicates the number of that item supplied.

Recording media, rechargeable battery pack, and AC Adaptor/Charger are sold separately. See page 18 for types of rechargeable battery packs that you can use on the camcorder. See page 46 for the recommended AC Adaptor/Charger.

AC Adaptor (AC-L100C) (1) (p. 18)

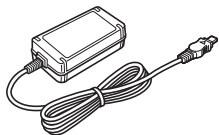

Power cord (mains lead) (1) (p. 18)



Wireless Remote Commander (RMT-845) (1) (p. 10)



A button-type lithium battery is already installed.

Large eyecup (1) (p. 24)



Lens hood with lens cover (1) (p. 21)

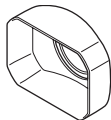

Accessory shoe kit (Accessory shoe (1), Accessory shoe plate (1), screws (4)) (p. 22)

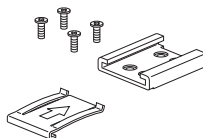

CD-ROM "Manuals for Digital HD Video Camera Recorder" (1)

Operating Guide (2)

Software Downloads

When the unit is used with a PC connection, download device drivers, plug-ins, and application software, where applicable, from the Sony Professional products web site.

Sony Professional products web site homepage:

U.S.A.	http://pro.sony.com
Canada	http://www.sonybiz.ca
Latin America	http://sonypro-latin.com
Europe, Middle East and Africa	http://www.pro.sony.eu
Japan	http://www.sonybsc.com
Asia Pacific	http://pro.sony-asia.com
Korea	http://bp.sony.co.kr
China	http://pro.sony.com.cn

Although the data regarding recorded materials are stored over multiple files and folders, you can easily handle the clips without considering its data and directory structure, by using the dedicated application software.

Step 2: Charging the battery pack

You can charge the “InfoLITHIUM” battery pack (L series) with the supplied AC Adaptor

⚡ Notes

- You can use a large capacity battery pack, NP-F770/NP-F970 (sold separately), with your camcorder. You cannot use NP-F570.

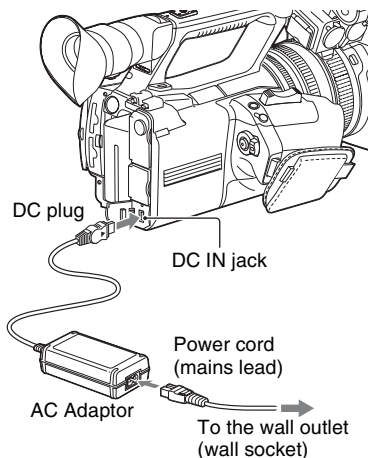

-
- 2 With the ► mark on the DC plug facing outwards, connect the DC plug to the DC IN jack on your camcorder.

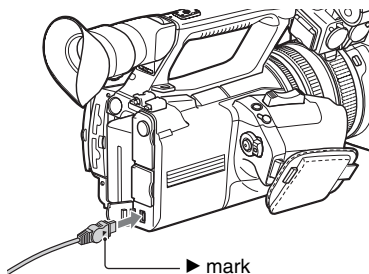

-
- 3 Connect the power cord (mains lead) to the AC Adaptor and the wall outlet (wall socket).

-
- 1 Press the battery pack against the back of your camcorder and slide it down.

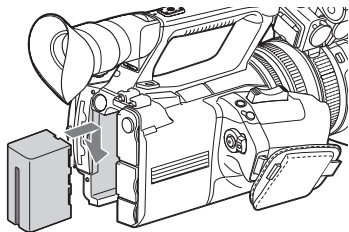

4 Set the POWER switch to OFF.

The CHG lamp lights up and charging starts.

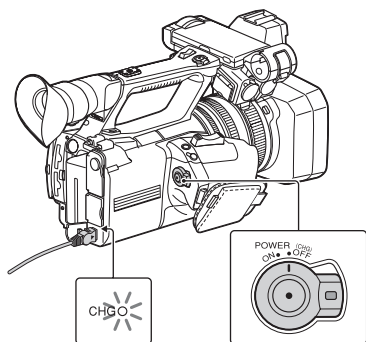

After charging the battery

The CHG lamp turns off when the battery is fully charged. Disconnect the AC Adaptor from the DC IN jack.

💡 Tips

- You can check the remaining battery life with the status check function (p. 70).

To remove the battery pack

Slide the POWER switch to OFF. Push the BATT RELEASE (battery release) button and slide the battery pack in the direction of the arrow.

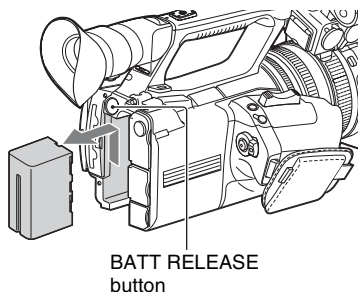

To store the battery pack

If the battery pack is not in use for a while, run down the battery and store it (p. 121).

Charging time

Approximate time (minute) required when you charge a fully discharged battery pack.

Battery pack	Full charge time
NP-F770	370
NP-F970	520

On the battery pack

- Before changing the battery pack, slide the POWER switch to OFF.
- The CHG lamp flashes during charging, or the Battery Info (p. 70) will not be correctly displayed under the following conditions.
 - The battery pack is not attached correctly.
 - The battery pack is damaged.
 - The battery pack is worn-out.

Step 2: Charging the battery pack (Continued)

Using an outside power source

You can use the AC Adaptor to obtain the AC power. While you are using the AC Adaptor, the battery pack will not lose its charge even when it is attached to your camcorder.

Follow the procedure from 1 to 3 as shown in “Step 2: Charging the battery pack” on page 18.

Notes

- The video light does not turn on when the AC adaptor AC-L100C (supplied) is used. To use the video light, use a battery pack (sold separately) (p. 45).
- By using the connecting cord DK-415 1-782-361- (sold separately) and the AC Adaptor/Charger AC-VL1 1-487-539- (sold separately), you can use the video light while using the camcorder on AC power. To purchase these products, consult your local authorized Sony service facility.

On the AC Adaptor

- Do not short-circuit the DC plug of the AC Adaptor or battery terminal with any metallic objects. This may cause a malfunction.

Step 3: Attaching the microphone and the lens hood with lens cover

Attaching the microphone

This section explains how to connect an external microphone. (ECM-673 (sold separately) is used for illustration purposes.) Refer also to the instruction manual of the actual microphone to be used. The following microphones are recommended.

- ECM-673 (INPUT TRIM set to [+6dB] recommended)
- ECM-VG1
- ECM-MS2 (stereo)

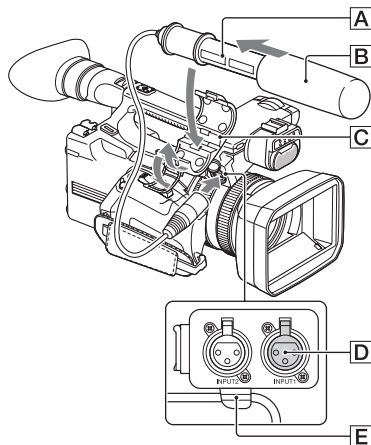

1 Attach an optional wind screen **B** to the optional microphone **A**.

2 Place the microphone **A** in the microphone holder **C** with the model name facing upward, close the cover, and shut the clamp.

-
- 3** Connect the plug of the microphone to the **INPUT 1** jack **D**.
-

- 4** Put the microphone cable into the cable holder **E**.

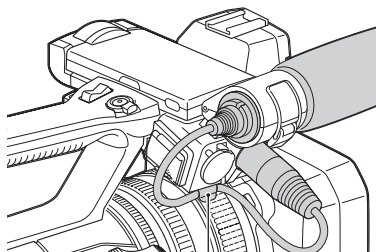

Put the cable in the outer cable holder.

Attaching the lens hood with lens cover

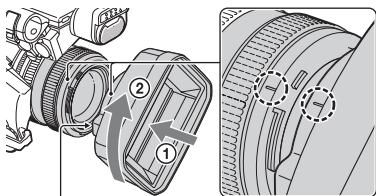

PUSH (lens hood release) button

Align the marks on the lens hood to those on the camcorder, and turn the lens hood in the direction of the arrow **2** until it is locked.

To remove the lens hood with lens cover

Turn the lens hood in the opposite direction to the arrow **2** in the illustration while pressing the PUSH (lens hood release) button.

💡 Tips

- If you attach or remove a 72mm (2 7/8 in.) PL filter or MC protector, remove the lens hood with lens cover.

To open or close the shutter of the lens hood with lens cover

Move the lens cover lever to OPEN to open the lens cover, and move the lever to CLOSE to close the lens cover.

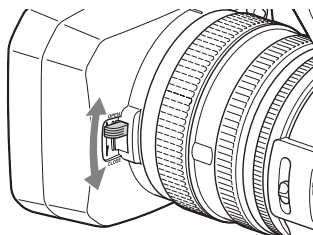

Step 4: Attaching the accessory shoe

When attaching an accessory other than the handle, attach the accessory shoe plate to the accessory shoe.

To mount the accessory shoe

Mount the accessory shoe on the accessory shoe mount as illustrated.

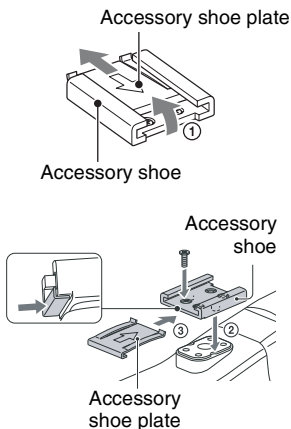

- ① Lift the edge of the accessory shoe plate and pull it in the direction opposite to that of the arrow on the accessory shoe plate and remove it from the accessory shoe.
- ② Place the accessory shoe as its protrusions matches recesses of the accessory shoe mount, then fix it to the mount with four screws.
- ③ Insert the accessory shoe plate in the direction of the arrow on the plate surface until the end of the plate engages the end of the shoe.

To remove the accessory shoe

Remove the shoe plate in the same way as step ① of "To mount the accessory shoe." Loosen the 4 screws and remove the accessory shoe from the accessory shoe mount.

Step 5: Turning on the camcorder and setting the date and time

Turning on the camcorder

Slide the POWER switch to ON while pressing the green button.

When you use your camcorder for the first time, the [CLOCK SET] screen appears.

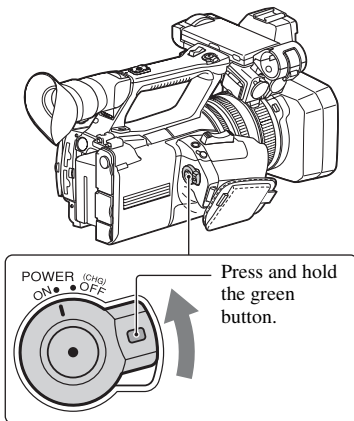

To turn off the power

Slide the POWER switch to OFF.

Notes

- If warning messages appear on the LCD screen, follow the instructions.

Setting the date and time

Set the date and time when you use your camcorder for the first time.

💡 Tips

- If you do not use your camcorder for **about 3 months**, the built-in rechargeable battery gets discharged and the date and time settings may be cleared from the memory. In that case, charge the rechargeable battery and then set the date and time again (p. 124).

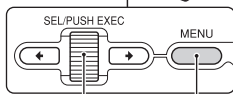
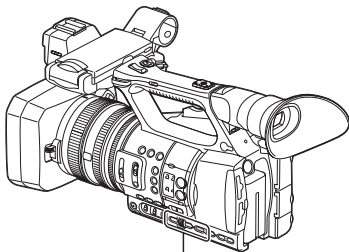

SEL/PUSH EXEC MENU button
dial

When you set the date and time again, press the MENU button, and select  (OTHERS) → [CLOCK SET].

1 Select your area by turning the SEL/PUSH EXEC dial, then press the dial.

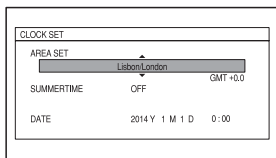

2 Set [SUMMERTIME], [Y] (year), [M] (month), [D] (day), hour and minute, by turning the SEL/PUSH EXEC dial, then press the dial.

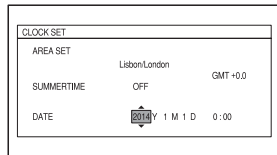

The clock starts.

- Set [SUMMERTIME] to [ON] to move the time forward 1 hour.
- You can set any year up to the year 2037.
- Midnight is indicated as 12:00 AM, and noon as 12:00 PM (NTSC model).

💡 Tips

- The date and time are automatically recorded on the selected recording media, and can be displayed during playback (DATA CODE button, p. 69).

Changing the language setting

You can change the on-screen displays to show messages in a specified language. Press the MENU button and select  (OTHERS) with the SEL/PUSH EXEC dial. Select the screen language in [LANGUAGE] (p. 100).

Step 6: Adjusting the LCD screen and viewfinder

Using the LCD screen

The LCD screen can be rotated in the range as illustrated below, allowing a person other than the camera operator to see the image.

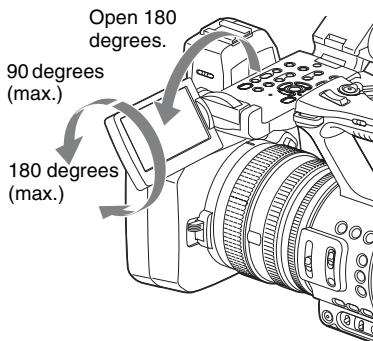

Adjusting the viewfinder

Viewfinder lens adjustment lever
Move it until the picture becomes clear.

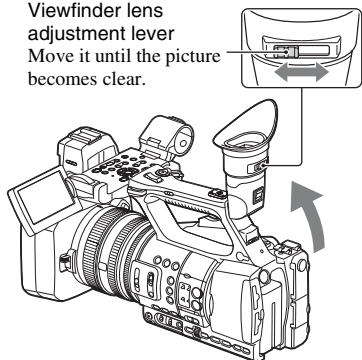

Notes

- You may see primary colors shimmering in the viewfinder when you move your line of sight. This is not a malfunction. The shimmering colors will not be recorded on the recording media.

Tips

- You can adjust the brightness of the viewfinder backlight from [VF BACKLIGHT] (p. 96).

When the picture in the viewfinder is hard to see

If you cannot see the picture in the viewfinder clearly under bright circumstances, use the supplied large eyecup. To attach the large eyecup, stretch it slightly and fit it over the groove of the eyecup attached to the camcorder. You can attach the large eyecup facing either the right or left side.

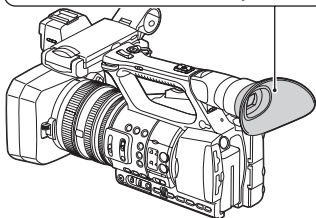
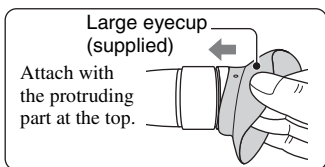

Notes

- Do not remove the pre-attached eyecup.

Step 7: Preparing the recording media

Memory card

Types of memory cards you can use in your camcorder

	Capacity (operation verified)
“Memory Stick PRO Duo” media (Mark2)*1	32 GB
“Memory Stick PRO-HG Duo” media*1	
“Memory Stick XC-HG Duo” media*1	64 GB
SD memory card*2	
SDHC memory card*2	
SDXC memory card*2	

*1 Described as “Memory Stick PRO Duo” media in this manual.

*2 Described as SD card in this manual.

⚙ Notes

- Operation with all memory cards is not assured.
- “Memory Stick PRO Duo” media, half the size of “Memory Stick” media, or standard size SD cards can be used for this camcorder.
- Use an SD card of Class 4 or faster. For standard image quality (DV) recording, use an SD card of Class 6 or faster, and for Slow & Quick Motion recording, use an SD card of Class 10 or faster.
- During the standard image quality (DV) and Slow & Quick Motion recording, images cannot be recorded on “Memory Stick PRO Duo” media.
- Do not attach a label or the like on memory card or memory card adaptor. Doing so may cause a malfunction.
- See page 115 for the recordable time of memory cards.
- Movies recorded on “Memory Stick XC-HG Duo” media or SDXC memory cards can be imported to or played back on other equipment, such as a computer or A/V device, by connecting the camcorder to the equipment with the USB cable. However, the equipment must support the exFAT file system used for “Memory Stick XC-HG Duo” media and SDXC memory cards. Confirm in advance that the

connecting equipment is supporting the exFAT file system. If you connect equipment not supporting the exFAT file system and the format screen appears, do not perform the format. All the data recorded will be lost.

Open the cover, and insert the memory card with the notched edge in the direction as illustrated until it clicks.

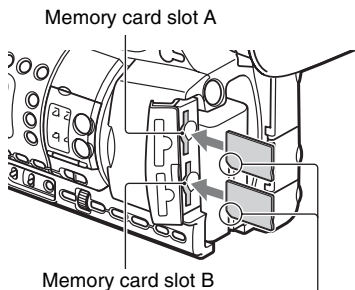

Note the direction of the notched corner.

- If you insert a memory card into the slot in the wrong direction, the memory card, the memory card slot, or image data may be damaged.
- Memory card slot A accepts either “Memory Stick PRO Duo” media or an SD card. Memory card slot B accepts an SD card only.

To eject the memory card

Lightly push the memory card once.

⚙ Notes

- If [The image database file is corrupted. The media must be restored to use again.] appears, format the memory card (p. 78).
- When inserting or ejecting the memory card, be careful of the memory card popping out and dropping.

Step 7: Preparing the recording media (Continued)

Selecting the memory card slot to be used for recording

Press the A or B button of the memory card slot where the memory card you want to record on is inserted. You can confirm the selected slot on the screen.

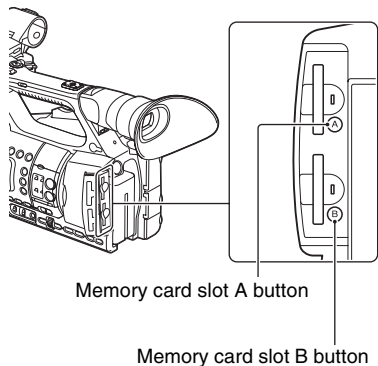

🔊 Notes

- You can only select a slot that already has a memory card inserted.
- While movies are being recorded on the memory card, you cannot switch the slot even if you press the memory card slot A/B buttons.

💡 Tips

- When only one slot has a memory card inserted, the slot that has the memory card is selected automatically.
- If the memory card is fully recorded during recording, the camcorder continues recording automatically on the memory card inserted in the other slot (Relay recording, p. 28).

Recording

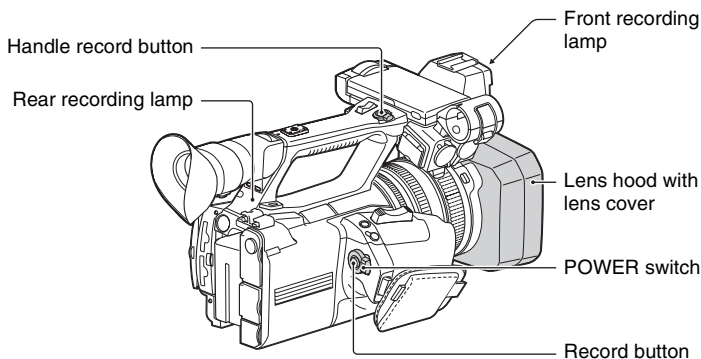

Recording movies

Your camcorder records movies on a memory card. The factory setting of recording movies is high definition image quality (HD). Do the following steps to record movies.

1 Open the shutter of the lens hood with lens cover.

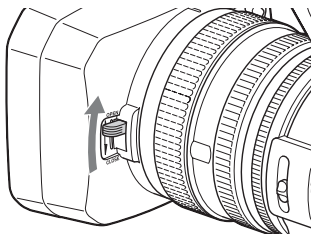

2 Slide the POWER switch to ON while pressing the green button.

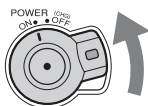

3 Press the record button or the handle record button.

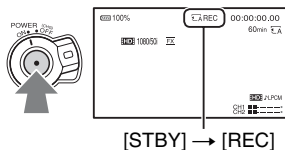

The recording lamps light up during recording.

To stop the movie recording, press the record button or the handle record button again.

Notes

- When the access lamp is lit or flashing in red, your camcorder is reading or writing data on recording media. Do not shake or apply strong force to your camcorder, do not turn the power off, and do not remove the recording media, battery pack or the AC Adaptor. The image data may be destroyed.
- See page 115 on the recording time of movies.
- Your camcorder can record a movie for about 13 hours continuously.
- If a movie file exceeds 2 GB during recording, the camcorder divides the file and create a new file automatically.
- The menu settings, the PICTURE PROFILE settings, and the settings made by the AUTO/MANUAL switch are stored in your camcorder when you slide the POWER switch to OFF. The access lamp lights up while the settings are being stored. If you remove the battery pack or the AC Adaptor before turning off the power, the settings may return to the default settings.
- [PP4] may be set for the picture profile by default, depending on the country or region. In that case, [PP4] is displayed when the POWER switch is set to ON (p. 53).

Tips

- When recording in high definition image quality (HD), the aspect ratio is fixed to 16:9. When recording in DV mode, you can switch the aspect ratio to 4:3 ([**HDV** WIDE REC], p. 89).
- You can change the screen display during recording (p. 69).
- Indicators displayed on the LCD screen during recording are shown on page 11.
- The recording lamps can be set to stay off ([REC LAMP[F]], [REC LAMP[R]], p. 100).
- You can capture still images from the movies you recorded (p. 77).

To continue recording on the memory cards, one after another (Relay recording)

Insert memory cards each in both slots A and B, so the camcorder switches memory card A (or B) just before space on the other one runs out, and continues recording on the next memory card automatically.

Do the following setting before recording.

Press MENU → Select **REC/OUT SET** → [REC SET] → [SIMUL/RELAY REC] → [RELAY REC] with the SEL/PUSH EXEC dial.

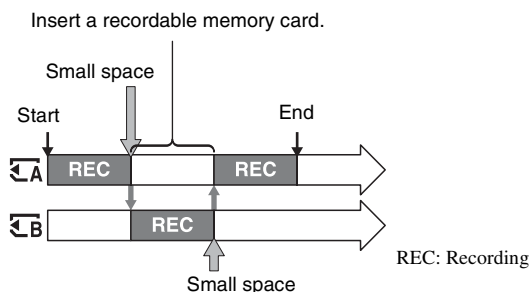

Notes

- Do not eject the memory card that is currently being used for recording. Replace only the memory card whose slot lamp is off.
- Even if you press the memory card slot button, A or B, while recording movies, you cannot switch the slot currently being used.
- When the remaining recording time of the memory card being used is less than 1 minute and the other slot has recordable memory card inserted, [$\overline{\text{A}} \rightarrow \overline{\text{B}}$] or [$\overline{\text{B}} \rightarrow \overline{\text{A}}$] appears on the camcorder screen. The indicator turns off when the memory card is switched.
- If you start recording on a memory card with the remaining recording time of less than 1 minute, the camcorder may not be able to relay-record. To relay-record without fail, make sure that the memory card has more than 1 minute when you start recording.
- Seamless playback of relay-recorded movies with this camcorder is not possible.
- You can re-combine relay-recorded movies using the application software “Content Browser” (Windows only).

To record movies using both the memory card A and B (Simultaneous recording)

You can record movies on both of these recording media simultaneously.

Press MENU \rightarrow select $\overline{\text{REC}} \overline{\text{OUT SET}}$ \rightarrow [REC SET] \rightarrow [SIMUL/RELAY REC] \rightarrow [SIMULTANEOUS REC] with the SEL/PUSH EXEC dial.

Changing the setting of the record button/handle record button

You can start and stop recording on different recording media at different timing by operating the record button and the handle record button.









In the default setting, movies are recorded on both the memory card A and B at the same time when either record button is pressed.

- REC BUTTON: $\overline{\text{A}}$ $\overline{\text{B}}$
- HANDLE REC BUTTON: $\overline{\text{A}}$ $\overline{\text{B}}$

Recording (Continued)

To change the setting

Press MENU → select  (REC/OUT SET) → [REC SET] → [REC BUTTON SET] with the SEL/PUSH EXEC dial.

[REC BUTTON:] setting	Button and recording media
REC BUTTON:   HANDLE REC BUTTON:  	Recording on both the memory card A and the memory card B starts and stops at the same time when either record button is pressed.
REC BUTTON:  HANDLE REC BUTTON: 	Recording on the memory card A starts and stops when the record button is pressed, and on the memory card B when the handle record button is pressed.
REC BUTTON:  HANDLE REC BUTTON: 	Recording on the memory card B starts and stops when the record button is pressed, and on the memory card A when the handle record button is pressed.

Adjusting the zoom

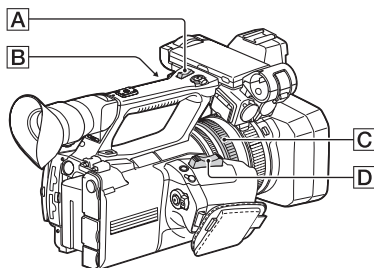

Adjusting the zoom with the power zoom lever

Move the power zoom lever **D** slightly for a slower zoom. Move it further for a faster zoom.

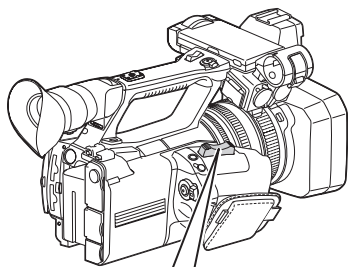

Wide view:
(Wide angle)

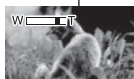

Close view:
(Telephoto)

💡 Tips

- The minimum distance required between your camcorder and the subject for focus is about 1 cm (about 13/32 in.) for wide angle and about 80 cm (about 2 5/8 feet) for telephoto.
- The focus may not be adjusted at certain zoom positions if the subject is within 80 cm (about 2 5/8 feet) from your camcorder.
- Be sure to keep your finger on the power zoom lever **D**. If you move your finger off the power zoom lever **D**, the operation sound of the power zoom lever **D** may also be recorded.
- You can increase the zoom speed of the power zoom lever **D** or the handle zoom **A** ([SPEED ZOOM], p. 87).

Adjusting the zoom with the handle zoom

- ① Set the handle zoom switch **B** to VAR or FIX.

💡 Tips

- When you set the handle zoom switch **B** to VAR, you can zoom in or out at variable speed.
 - When you set the handle zoom switch **B** to FIX, you can zoom in or out at fixed speed set in [HANDLE ZOOM] (p. 87).
- ② Press the handle zoom lever **A** to zoom in or out.

⚠ Notes

- You cannot use the handle zoom lever **A** when the handle zoom switch **B** is set to OFF.
- You cannot change the zoom speed of the power zoom lever **D** with the handle zoom switch **B**.

Adjusting the zoom with the zoom ring

You can zoom at the desired speed by turning the zoom ring **C**. Fine adjustment is also possible.

⚠ Notes

- Turn the zoom ring **C** at a moderate speed. If you turn it too fast, the zoom speed may lag behind the zoom ring rotation speed, or the operation sound of the zoom may also be recorded.

Adjusting the focus

You can adjust the focus manually for different recording conditions.

Use this function in the following cases.

- To record a subject behind a window covered with raindrops.
- To record horizontal stripes.
- To record a subject with little contrast between the subject and its background.
- When you want to focus on a subject in the background.

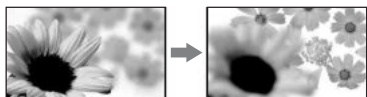

- To record a stationary subject using a tripod.

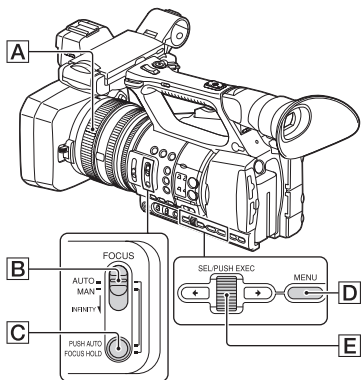

1 During recording or standby, set the FOCUS switch **B** to MAN.

appears.

2 Rotate the focus ring **A** and adjust the focus.

changes to when the focus cannot be adjusted any farther. changes to when the focus cannot be adjusted any closer.

To restore automatic adjustment

Set the FOCUS switch **B** to AUTO.

disappears and the automatic focus adjustment is restored.

Tips

- The focal length information (the distance at which the subject is in focus; for when it is dark and hard to adjust the focus) appears for about 3 seconds in the following cases.
 - When you set the FOCUS switch **B** to MAN and appears on the LCD screen.
 - When you rotate the focus ring **A** while is displayed on the LCD screen.
- You can switch the focal length information between meters and feet ([FOCUS DISPLAY], p. 95).

Using automatic focus/fixing focus temporarily (Push auto focus/Focus hold)

Push auto focus

Set the FOCUS switch **B** to MAN, then press and hold the PUSH AUTO/FOCUS HOLD button **C**. The image is shot with automatic focus. Keep the button pressed to shoot. If you release the button, the setting returns to manual focusing.

Focus hold

Set the FOCUS switch **B** to AUTO, then press and hold the PUSH AUTO/FOCUS HOLD button **C**. The image is shot with the focus fixed at the point you start to press the PUSH AUTO/FOCUS HOLD button. Keep the button pressed to shoot. If you release the button, the setting returns to auto focusing.

Using the expanded focus (Expanded focus)

The selected area on the LCD screen is magnified and displayed. It is easier to confirm the focus setting during manual focusing. [FOCUS MAGNIFIER] is assigned to the ASSIGN 6 button (p. 62).

Press ASSIGN 6 button

The center of the screen is magnified. The setting changes with each press of the button.

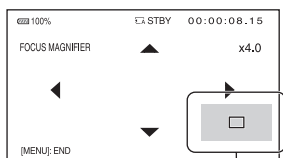

Enlarged display position

You can adjust the enlarged display position with the $\uparrow/\downarrow/\leftarrow/\rightarrow$ button on the camcorder. Press the EXEC button to set the enlarged display position back to the center.

Notes

- Even though the image appears expanded on the LCD screen, the recorded image is not expanded.

Tips

- You can change the magnification ratio with [FOCUS MAG RATIO] (p. 94).

Focusing on a distant subject (Focus infinity)

Slide the FOCUS switch \boxed{B} to INFINITY and hold it there.

$\textcircled{\infty}$ appears on the screen.

To return to manual focus mode, release the FOCUS switch \boxed{B} . This function enables you to set focus on a distant subject even when the focus is automatically set on a close subject.

Notes

- This function is only available during the manual focus. It is not available during the automatic focus.

Focusing by touching the LCD screen (Spot focus)

You can focus on the point where you touch on the LCD screen.

1 Press the MENU button \boxed{D} .

2 Select $\boxed{\text{CAMERA SET}}$ \rightarrow [SPOT FOCUS] with the SEL/PUSH EXEC dial \boxed{E} .

3 Touch the point to be focused on the LCD screen.

Notes

- [SPOT FOCUS] is available only when the FOCUS switch \boxed{B} is set to MAN.

Tips

- You can assign this function to an ASSIGN button (p. 62).

To cancel the spot focus

Press the MENU button \boxed{D} .

Focusing on a detected face (Face detection)

The camcorder detects the face and focuses on it (The default setting is [OFF]). You can use this function when the FOCUS switch **[B]** is set to AUTO.

1 Press the MENU button **[D]**.

2 Select **[CAMERA SET]** → **[FACE DETECTION]** → **[ON]** or **[OFF]** with the SEL/PUSH EXEC dial **[E]**.

When the faces are detected, frames appear on the LCD screen.

3 Move the selection cursor (orange colored frame), and select the priority face with the SEL/PUSH EXEC dial **[E]**, then press the dial.

Selection cursor
(orange colored frame)



Priority face frame
(double frame)

The frame on the priority face changes to a double frame.

To cancel the priority face

Move the selection cursor (orange colored frame) onto the frame (double frame) on the priority face, using the SEL/PUSH EXEC dial **[E]**, then press the dial.

⚙ Notes

- Faces may not be detected depending on the recording environment, the condition of the subject or the settings.
- You may not be able to get the proper effect in some recording environments. If this happens, set [FACE DETECTION] to [OFF].
- The face detection function will be canceled when you use the digital zoom.

💡 Tips

- You can assign this function to an ASSIGN button (p. 62).
- To make it easy to detect faces, record under the following conditions:
 - Record in a moderately bright place
 - Do not obscure the face with a hat, mask, sunglasses, etc.
 - Face the front of the camera
- When [FACE DETECTION] is set to [ON], you cannot adjust shutter speed, etc. To adjust shutter speed, etc., set [FACE DETECTION] to [OFF] temporarily by setting the FOCUS switch **[B]** to MAN.

Changing the recording setting

Selecting the recording format for high definition image quality (HD)

You can select the recording format (bit-rate, image size, frame rate, scanning system). The default setting is as follows:
NTSC model: [HD] 1080/60i [FX]
PAL model: [HD] 1080/50i [FX]

1 Press the MENU button.

2 Select \rightarrow (REC/OUT SET) \rightarrow [REC SET] \rightarrow [HD] REC FORMAT \rightarrow a desired format with the SEL/PUSH EXEC dial.

Setting value

NTSC model	PAL model
1080/60i FX	-
1080/60i FH	-
1080/60i HQ	1080/50i FX
1080/60i LP	1080/50i FH
1080/60p PS	1080/50i HQ
720/60p FX	1080/50i LP
720/60p FH	1080/50p PS
720/60p HQ	720/50p FX
1080/30p FX	720/50p FH
1080/30p FH	720/50p HQ
1080/24p FX	1080/25p FX
1080/24p FH	1080/25p FH

- Bit-rate
PS: max. 28 Mbps
FX: max. 24 Mbps
FH: approx. 17 Mbps (average)
HQ: approx. 9 Mbps (average)
LP: approx. 5 Mbps (average)

- Image size
PS: 1,920×1,080
FX: 1,920×1,080/1,280×720
FH: 1,920×1,080/1,280×720
HQ: 1,440×1,080/1,280×720
LP: 1,440×1,080
- Frame rate
NTSC model: Either 60 or 30 or 24
PAL model: Either 50 or 25
- Scanning system
i: interlace
p: progressive

If you select [1080/60i FX] (NTSC model) or [1080/50i FX] (PAL model), for example, movies are recorded with following format.

- 1080: Effective scanning lines
- 60, 50: Frame rate
- i: Scanning system
- FX: Recording mode

Frame rate at 60i (NTSC model)

The frame rate displayed on the LCD screen differs from the actual frame rate.

Frame rate on the LCD screen	Actual frame rate
24	23.98
30	29.97
60	59.94

Notes

- Movies recorded with the recording mode set to PS or FX on [HD] REC FORMAT can be saved on an external media device only (p. 102).
- When [SIMUL/RELAY REC] is set to [MP4 SIMUL REC], [HD] REC FORMAT cannot be set to [1080/60p PS] (NTSC model) or [1080/50p PS] (PAL model).

Tips

- The recording format of 720/60i HQ (NTSC model) or 720/50i HQ (PAL model) is automatically selected for the standard definition image quality (DV) recording.



Recording MP4 movies

You can record an MP4 movie simultaneously while recording a high definition (HD) movie.

1 Press the MENU button.

2 Select \rightleftarrows (REC/OUT SET) \rightarrow [REC SET] \rightarrow [SIMUL/RELAY REC] \rightarrow [MP4 SIMUL REC] with the SEL/PUSH EXEC dial.

Notes

- For MP4 movies, the recording format is fixed to [720/30p] (NTSC model) or [720/25p] (PAL model), and the audio format is fixed to AAC.
- When the frame rate of high definition image quality (HD) is 24p, the frame rate of MP4 movies is 24p (NTSC model).
- [] REC FORMAT cannot be set to [1080/60p PS] (NTSC model)/[1080/50p PS] (PAL model) when recording MP4 movies.
- [MP4 SIMUL REC] is not available in the following settings.
 - The camcorder is in DV mode
 - [COLOR BAR] is set to [ON]
 - [DATE REC] is set to [ON]
 - When [] REC FORMAT is set to [1080/60p PS] (NTSC model)/[1080/50p PS] (PAL model)
 - When recording with the Slow & Quick Motion function
- The following information is not applied to MP4 movies
 - Time code
 - User bit
- MP4 movies recorded on the camcorder cannot be played back, deleted, copied, or protected on the camcorder.
- If a movie file exceeds 2 GB, the camcorder automatically creates a new file and continues recording.

Functions not available during MP4 movie recording

- DV mode
- COLOR BAR
- DATE REC
- S&Q MOTION
- FACE DETECTION

Setting the DV MODE (DV mode)

You can record/play back in DV mode of standard image quality

1 Press the MENU button.

2 Select \rightleftarrows (REC/OUT SET) \rightarrow [REC SET] \rightarrow [DV MODE] \rightarrow [YES] with the SEL/PUSH EXEC dial.

The camcorder restarts in DV mode.

Notes

- DV mode cannot be selected when [SIMUL/RELAY REC] is set to [MP4 SIMUL REC].

Functions not available in DV mode

- Viewing still images
- Protecting recorded movies and still images (Protect)
 - [PROTECT] is not displayed on the [EDIT] menu.
- Dividing a movie
 - [DIVIDE] is not displayed on the [EDIT] menu.
- Copying movies and still images
 - DV files cannot be copied, including copies onto external media.
 - [COPY] is not displayed on the [EDIT] menu.
- Capturing still images from a movie

Menu items which cannot be used in DV mode

- ↔ (REC/OUT SET)
 - [HD] REC FORMAT
- ♪ (AUDIO SET)
 - [HD] AUDIO FORMAT

Notes

- When you select DV mode, [HD] AUDIO FORMAT] is fixed to [LINEAR PCM], and [♪ LPCM] is not displayed on the screen.

When the camcorder is set to DV mode, the following items can be used.

- ↔ (REC/OUT SET)
 - [DV] WIDE REC
 - CANCEL DV MODE

Notes

- When you switch from DV mode to another, settings made in DV mode are initialized. If a movie file exceeds 2 GB during recording, the camcorder divides the recording into separate files by creating a new file(s) automatically. However, the divided files are displayed as a single movie on the screen of the camcorder.

Canceling the DV MODE

- ① Press the MENU button.
- ② Select ↔ (REC/OUT SET) → [REC SET] → [CANCEL DV MODE] → [YES] with the SEL/PUSH EXEC dial.

When DV mode is canceled, the following settings return to the default.

- [HD] REC FORMAT
- FRAME RATE
- Recording Setting
- Image size
- SIMUL/RELAY REC
- [HD] AUDIO FORMAT

Adjusting the brightness

You can adjust the image brightness by adjusting the iris, gain or shutter speed, or by adjusting the light volume with the ND filter **B**.

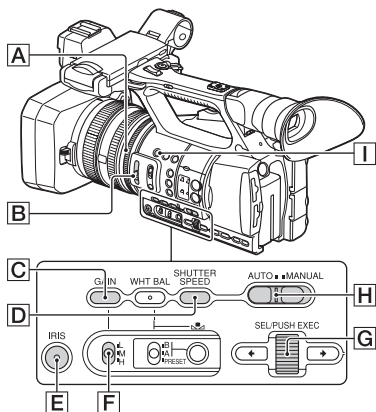

Notes

- When you set the AUTO/MANUAL switch **H** to AUTO, iris, gain, shutter speed and white balance are adjusted automatically. You cannot adjust any of them manually.

Adjusting the iris

This is handy for making the background blurred or sharp.

- 1 Set the AUTO/MANUAL switch **H** to MANUAL.**

- 2 Press the IRIS button **E**.**

A or **B** next to the iris value disappears.

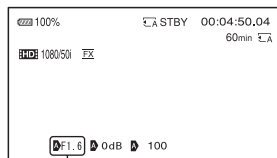

- 3 Adjust the iris with the iris ring **A**.**

The volume of the light increases the more that you open the aperture (decreasing F value). The volume of the light decreases the more that you close the aperture (increasing F value).

To temporarily adjust the iris automatically

Hold the IRIS PUSH AUTO button **I** down.

The iris is adjusted automatically for as long as you hold the button down.

To adjust the iris automatically

Press the IRIS button **E**.

The iris value disappears or **A** appears next to the iris value. When AE is fixed, **B** appears next to the iris value.

Adjusting the gain

You can use this if you do not want to increase the value by AGC (automatic gain control).

1 Set the **AUTO/MANUAL** switch **[H]** to **MANUAL**.

2 Press the **GAIN** button **[C]**.

[A] or **[E]** next to the gain value disappears.

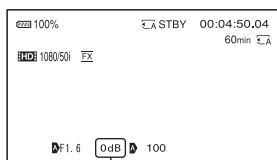

Gain value

3 Set the gain switch **[F]** to **H**, **M** or **L**.

The gain value set for the selected gain switch position appears on the LCD screen. You can set the gain value from [GAIN SET] of the **[CAMERA SET]** menu (p. 86).

To adjust the gain automatically

Press the **GAIN** button **[C]**.

The gain value disappears, or **[A]** appears next to the gain value. When **AE** is fixed, **[E]** appears next to the gain value.

Tips

- If you record with gain set to [-6dB] and play back with the data code displayed, the gain value will be displayed as [---].

Adjusting the shutter speed

You can adjust and fix the shutter speed manually. You can make a moving subject look still or emphasize the movement of a subject by adjusting the shutter speed.

1 Set the **AUTO/MANUAL** switch **[H]** to **MANUAL**.

2 Press the **SHUTTER SPEED** button **[D]** to highlight the shutter speed value.

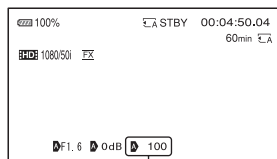

Shutter speed value

3 Change the shutter speed displayed on the LCD screen by turning the **SEL/PUSH EXEC** dial **[G]**.

The following shutter speed adjustment ranges are available:

NTSC model: You can select from 1/4 to 1/10000

(1/3 - 1/10000 when shooting with 24p)

PAL model: You can select from 1/3 to 1/10000

The denominator of the set shutter speed appears on the LCD screen. For example, [100] appears on the LCD screen when you set the shutter speed to 1/100 second. The larger the value on the LCD screen is, the faster the shutter speed is.

Adjusting the brightness (Continued)

4 Press the SEL/PUSH EXEC dial **[G]** to lock the shutter speed.

To readjust the shutter speed, repeat steps from 2.

Tips

- It is difficult to focus automatically at a lower shutter speed. Manual focusing with your camcorder attached to a tripod is recommended.
- When recording under fluorescent lamps, sodium lamps, or mercury lamps, the picture may flicker or change colors, or may have horizontal bands of noise. You may be able to improve the situation by adjusting the shutter speed to 1/100 if the power frequency of your area is 50 Hz, or 1/60 in a 60 Hz area.
- You can switch the shutter speed display between seconds and degrees ([SHUTTER DISPLAY], p. 95).

To adjust the shutter speed automatically

Press the SHUTTER SPEED button **[D]** once.

The shutter speed value disappears, or **[A]** appears next to the shutter speed value. When AE is fixed, **[E]** appears next to the shutter speed value.

Adjusting the exposure

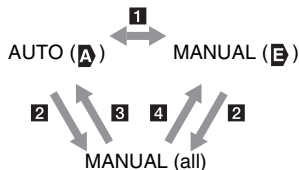

1 When you set AUTO/MANUAL switch in [SPOT METER] or [SPOT METER/ FOCUS]

2 When all of iris, gain and shutter speed are set manually.

3 When the last setting of the exposure is set to AUTO, and any item in **2** is set to AUTO.

4 When the last setting of the exposure is set to MANUAL, and any item in **2** is set to AUTO.

Notes

- When you set AUTO/MANUAL switch to AUTO, or press [EXEC] on the [SPOT METER] or [SPOT METER/FOCUS] screen, the exposure is returned to AUTO.

Adjusting the volume of light (ND filter)

You can record the subject clearly by using the ND filter **[B]** when the recording environment is too bright.

The ND filters 1, 2 and 3 reduce the volume of light to about 1/4, 1/16 and 1/64, respectively.

If **ND1** flashes during the iris automatic adjustment, set the ND filter to 1. If **ND2** flashes during the iris automatic adjustment, set the ND filter to 2. If **ND3** flashes during the iris automatic adjustment, set the ND filter to 3.

The ND filter indicator will stop flashing and remain on the screen.

If **NDOFF** flashes, set the ND filter to OFF.

The ND filter icon will disappear from the screen.

Notes

- If you change the ND filters **[B]** during recording, the movie and sound may be distorted.
- When adjusting the iris manually, the ND filter icon does not flash even if the light volume should be adjusted with the ND filter.
- If the camcorder cannot detect the ND filter position (OFF/1/2/3), **ND** flashes on the screen. Make sure that the ND filter is set correctly.

Tips

- While recording a bright subject, diffraction may occur if you close the aperture further down, resulting in a fuzzy focus (this is a common phenomenon with video cameras). The ND filter **[B]** suppresses this phenomenon and gives better recording results.

Adjusting the color tone

Adjusting the white balance

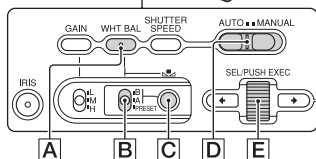
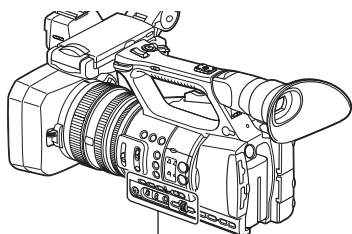

You can adjust and fix the white balance according to the lighting conditions of recording environment.

You can store white balance values in memory A (A) and memory B (B), respectively. Unless a white balance is readjusted, values will remain even after the power has been turned off.

When you select PRESET, [OUTDOOR], [INDOOR] or [MANU WB TEMP] is selected, according to which one you previously set with [WB PRESET] in the (CAMERA SET) menu.

💡 Tips

- You can assign [WB PRESET] to an ASSIGN button (p. 62).

1 Set the AUTO/MANUAL switch **D** to MANUAL.

2 Press the WHT BAL button **A** to display the WHT BAL indicator.

3 Set the white balance memory switch **B** to any one of PRESET/A/B.

■ Setting the A/B value

Select A or B for recording with the white balance setting stored in memory A or B.

See page 42 on how to store the adjusted value.



■ To use the PRESET value of white balance

Select (CAMERA SET) → [WB PRESET] → a desired setting.





Setting value	Example of recording conditions
☀️ (outdoor) ([OUTDOOR])	<ul style="list-style-type: none">• When recording a night scene, neon lighting, fireworks, etc.• When recording a sunrise, sunset, etc.• Under daylight fluorescent lamp
🏠 (indoor) ([INDOOR])	<ul style="list-style-type: none">• Where lighting conditions change, such as at a party place, etc.• Under video light, such as in a studio, etc.• Under a sodium or mercury lamp
Color temperature setting ([MANU WB TEMP])	<ul style="list-style-type: none">• You can set a desired color temperature between 2300K and 15000K with (CAMERA SET) → [WB TEMP SET]. (The default setting is 6500K.)

Adjusting the color tone (Continued)



Tips

- You can change the outdoor white balance setting by setting an offset value. Press  (one push) button **[C]** while  (outdoor) is selected and turn the SEL/PUSH EXEC dial **[E]** to select an offset value from -7 (bluish) to 0 (normal, the default setting) to +7 (reddish). You can also set the white balance offset value from the menu ([WB OUTDOOR LEVEL], p. 87).
- You can change the color temperature. Press the  (one push) button **[C]** when [MANU WB TEMP] is set. Turn the SEL/PUSH EXEC dial **[E]** until the desired temperature appears on the LCD screen, then press the dial to set the temperature ([WB TEMP SET], p. 87).

To save the adjusted white balance value in memory A or B

- ① Set the AUTO/MANUAL switch **[D]** to MANUAL.
- ② Press the WHT BAL button **[A]** to display the WHT BAL indicator.
- ③ Set the white balance memory switch to A ( A) or B ( B).
- ④ Capture a white subject, such as white paper, full-screen in the same lighting condition as the one in which the subject is.
- ⑤ Press the  (one push) button **[C]**. The adjusted value is stored in  A or  B. The stored color temperature appears for about 3 seconds.

Notes

- When a white balance adjustment value has not been obtained successfully,  A or  B turns to slow flashing. Adjust the subject appropriately and set the shutter speed to auto or around 1/60 (NTSC model)/1/50 (PAL model), then try adjusting the white balance again.
- It may take a long time to adjust the white balance, depending on the recording conditions. If you want to perform a different operation before completing the adjustment, set the white balance memory switch **[B]** to another position to temporarily suspend white balance adjustment.

To adjust the white balance automatically

Press the WHT BAL button **[A]**.

Notes

- When you set the AUTO/MANUAL switch **[D]** to AUTO, iris, gain, shutter speed and white balance are adjusted automatically. You cannot adjust manually.

Audio setup

The following jacks, switches and dials allow you to set the sound to be recorded. See page 20 for details on attaching the microphone.

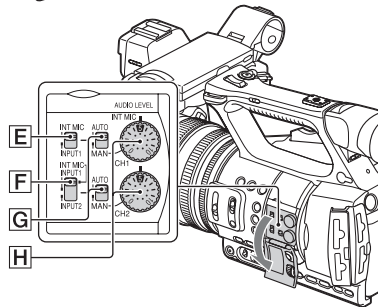
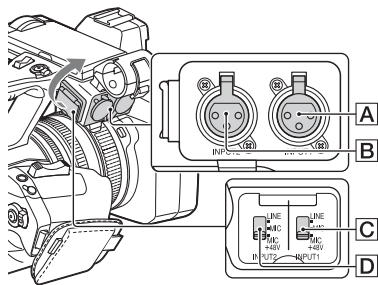

External audio jacks and switches

- INPUT 1 jack **A**
- INPUT 2 jack **B**
- INPUT 1 switch **C**
- INPUT 2 switch **D**

Audio source switches

- CH1 (INT MIC/INPUT 1) switch **E**
- CH2 (INT MIC/INPUT 1/INPUT 2) switch **F**

Audio level controls

- AUTO/MAN (CH1) switch **G**
- AUTO/MAN (CH2) switch **G**
- AUDIO LEVEL (CH1) dial **H**
- AUDIO LEVEL (CH2) dial **H**

Using the internal microphone

The sound will be recorded in stereo when using the internal microphone.

Set the CH1 (INT MIC/INPUT1) and CH2 (INT MIC/INPUT1/INPUT2) switches to INT MIC.

💡 Tips

- If the recording sound is small, set [INT MIC SENS] (p. 91) to [HIGH].
- To reduce the wind roar, set [INT MIC WIND] (p. 91) to [ON].

Recording sound from an external audio device

To use a microphone (sold separately), or an external audio device, change the following settings.

1 Select the input source.

Set the INPUT 1/INPUT 2 switches according to the devices connected to the INPUT 1/INPUT 2 jacks.

Audio devices	Switch position
External audio device (mixer, etc.)	LINE
Dynamic microphones or microphones with a built-in battery	MIC
+48V powering (Phantom powering) microphone	MIC+48V

- If you connect a device that does not support +48V phantom power, malfunction may result from setting this switch to MIC+48V. Check before connecting the device.

Audio setup (Continued)

- When there is no audio device connected to an INPUT jack, set the INPUT switch of that jack to LINE to prevent noise.



2 Set the input level of the microphone.

- Set the input level to the sensitivity of an XLR microphone you are using with [INPUT1 TRIM]/[INPUT2 TRIM] in the menu (p. 92).
- You can set an input level between -60 dBu (+12dB) and -30 dBu (-18dB) by 6dB. The default setting is -48 dBu (0dB).



3 Select the channel you want to record.

Using the CH1/CH2 switches, select the source to be recorded on each channel.

When the CH1 switch is set to INT MIC

Input source and recorded channel	CH2 switch setting
INT MIC (L) → CH1 INT MIC (R) → CH2	
INT MIC (mono) → CH1 INPUT 1 → CH2	
INT MIC (mono) → CH1 INPUT 2 → CH2	

When the CH1 switch is set to INPUT 1

Input source and recorded channel	CH2 switch setting
INPUT 1 → CH1 INT MIC (mono) → CH2	
INPUT 1 → CH1 INPUT 2 → CH2	
INPUT 1 → CH1 INPUT 2 → CH2	

Tips

- When you use a stereo microphone (2 XLR plugs), connect the L (left) channel plug to the INPUT 1 jack, and the R (right) channel plug to the INPUT 2 jack. Set the CH1 switch to INPUT 1, and the CH2 switch to INPUT 2.

Adjusting the volume

When both the CH1/CH2 switches are set to INT MIC, left and right channels are linked to the CH1 switch and dial.

1 Set the AUTO/MAN switch (G) of the channel to be adjusted to MAN.

 M₂ appears on the LCD screen.

2 During recording or standby, turn the AUDIO LEVEL dial (H) of the channel to be adjusted.

Useful functions

To restore automatic adjustment

Set the AUTO/MAN switch (G) of the manually adjusted channel to AUTO.

Setting the headphone sound

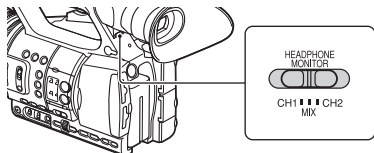

When you select CH1 or CH2, the respective channel's (input) sound is output to the headphones.

When you select MIX, both CH1 and CH2 input sounds are output to the headphones. You can select [MONO] or [STEREO] on [HEADPHONE OUT] for the audio output when MIX is selected. (p. 91).

Recording in dim places (Video light)

Slide the LIGHT switch to ON.

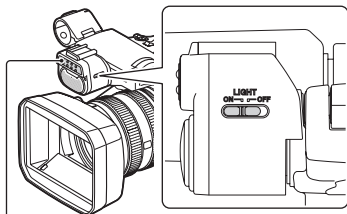

Video light

Notes

- The video light does not turn on when the AC adaptor AC-L100C (supplied) is used. To use the video light, use a battery pack (sold separately).
- If you use the video light with an XLR microphone attached, the microphone may cast a shadow in the shooting frame depending on the zoom position.
- The video light generates strong light. Do not use the video light directly in front of the eyes at close range.
- The battery drains quickly while using the video light.
- When the video light is lit, automatic white balance adjustment may not work properly depending on the recording conditions. In this case, use the one push white balance function (p. 42).
- It may take several seconds for the video light to turn off after you turn off the power of the camcorder with a remote commander (sold separately) connected to the REMOTE jack.

Useful functions (Continued)

To use the video light while powering from a wall outlet (wall socket)

By using the AC Adaptor/Charger AC-VL1 1-487-539- (sold separately) and the connecting cord DK-415 1-782-361- (sold separately), you can use the video light while using the camcorder on AC power. To purchase these products, consult your local authorized Sony service facility.

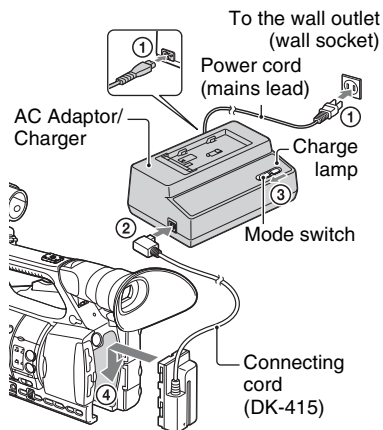

- 1 Connect the power cord (mains lead) to the AC Adaptor/Charger.
- 2 Connect the connecting cord (DK-415) to the AC Adaptor/Charger.
- 3 Set the mode switch of the AC Adaptor/Charger to VCR/CAMERA.
- 4 Press the connecting part of the connecting cord (DK-415) against the back of your camcorder in the battery slot and slide it in the direction of the arrow.

Selecting the suitable setting automatically for the recording situation (AUTO MODE setting)

You can make optimal recordings in various situations.

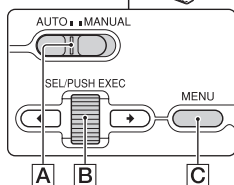
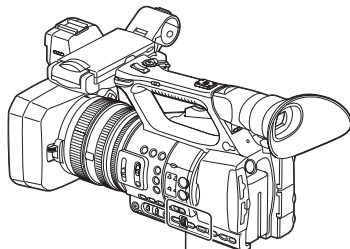

- 1 Set the AUTO/MANUAL switch **A** to AUTO.
- 2 Press the MENU button **C**.
- 3 Select **▶** (CAMERA SET) → [AUTO MODE SET] with the SEL/PUSH EXEC dial **B**.
- 4 Select [AUTO], [INTELLIGENT AUTO], or [SCENE SELECTION] with the SEL/PUSH EXEC dial **B**, then press the dial.

Notes

- When you select [INTELLIGENT AUTO], [STEADYSHOT] is set to [ACTIVE], and the angle of view shifts 1.08 times toward the telephoto side.

Scenes detected by INTELLIGENT AUTO

Face detection: 👤 (Portrait), 👶 (Baby)

Scene detection: 🏠 (Backlight),

🏞️ (Landscape), 🌙 (Night Scene),

🔦 (Spotlight), ⚡ (Low Brightness),

🌸 (Macro)

Camera-shake detection: 🚶 (Walk),

🦿 (Tripod)

To use [SCENE SELECTION]

- Press the MENU button, select  (CAMERA SET) → [SCENE SELECTION SET] with the SEL/PUSH EXEC dial, then press the dial.
- Select the desired setting with the SEL/PUSH EXEC dial, then press the dial.

Setting	Recording conditions
🌙 Night Scene* ([NIGHT SCENE])	Shoots a night view with a proper exposure, using a tripod (sold separately).
🌅 Sunrise & Sunset* ([SUNRISE & SUNSET])	Shoots the scenes under the glow of sunset/sunrise vividly.
🎆 Fireworks* ([FIREWORKS])	Shoots fireworks with optimal exposure.
🏞️ Landscape* ([LANDSCAPE])	Shoots distant subjects clearly. This setting also prevents your camcorder from focusing on any glass or mesh in windows between the camcorder and the subject.

Setting	Recording conditions
👤 Portrait ([PORTRAIT])	Brings out the subject, such as people or flowers, while creating a soft background.
🔦 Spotlight ([SPOTLIGHT])	Prevents people's faces from appearing excessively white when subjects are lit by strong light.
🌊 Beach ([BEACH])	Takes the vivid blue of the ocean or a lake.

* Focuses on only distant subjects.

What you can do with the Wi-Fi function of the camcorder

The Wi-Fi function of the camcorder enables you to operate the camcorder remotely by a smartphone, or transfer recorded images to a smartphone.

Using a smartphone as a remote controller (One-touch remote (NFC))

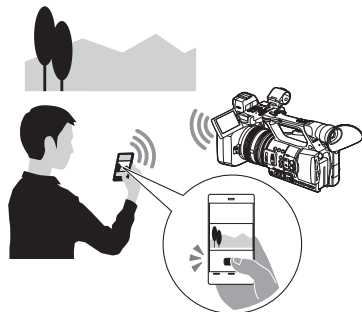

Required equipment/environment

Smartphone or tablet computer

Useful functions (Continued)

Transferring images to your smartphone

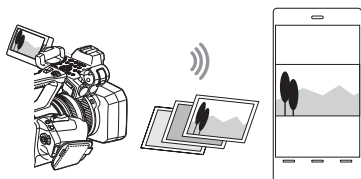

Required equipment/environment

Smartphone or tablet computer

Downloading “PlayMemories Mobile”

You need to install the dedicated application “PlayMemories Mobile” on your smartphone in order to transfer images to it. If “PlayMemories Mobile” is already installed on your smartphone, update it to the latest version as necessary. For the latest information and functional detail, refer to the following website.
<http://www.sony.net/pmm/>



Android OS

Search for “PlayMemories Mobile” in Google Play, then install it.



- You need Android 4.0 or later when you use the NFC One-touch.

iOS

Search for “PlayMemories Mobile” in the App Store, then install it.



- You cannot use the NFC One-touch when you use iOS.

Notes

- You need an NFC-compatible smartphone or tablet computer in order to use the NFC One-touch function of the camcorder.
- Proper operation of the Wi-Fi function detailed in this manual is not guaranteed for all smartphones or tablet computers.
- Operations and screen displays of the application may be subject to change without notice by future upgrades.

Connecting the camcorder to an Android smartphone equipped with the NFC function using One-touch

- 1 Select [Settings] on the smartphone, then select [More...] and place a checkmark next to [NFC].

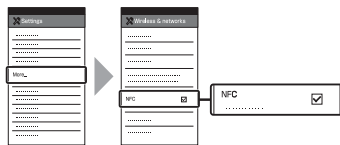

- 2 Set the camcorder to the shooting mode.

You can use the NFC function only when **N** (N-Mark) is displayed on the screen.

3 Touch the smartphone on the camcorder.

The smartphone connects to the camcorder, “PlayMemories Mobile” is activated and [CTRL W/ SMARTPHONE] starts on the camcorder.

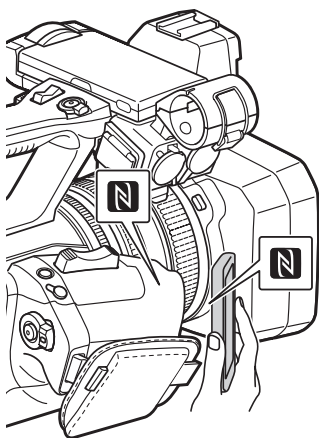

Notes

- Cancel the sleep mode and screen lock of the smartphone beforehand.
- Continue to touch (1 second-2 seconds) on the camcorder without moving, until “PlayMemories Mobile” starts up.
- While [CTRL W/SMARTPHONE] is activated, only the record button and handle record button are available on the camcorder.
- The smartphone cannot be connected to the camcorder when [AIRPLANE MODE] is set to [ON]. Set [AIRPLANE MODE] to [OFF] (p. 98).

Using a smartphone as a remote controller

You can control some of the camcorder's movie shooting functions remotely with a smartphone.

To start [CTRL W/SMARTPHONE] using the NFC function, see p. 48.

1 Press the MENU button.







2 Select (NETWORK SET) → [CTRL W/SMARTPHONE] with the SEL/PUSH EXEC dial.

3 Connect the smartphone to the camcorder, using the information that appears on the screen when the camcorder is ready to be connected.

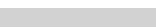
The connection method will depend on the type of smartphone.

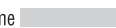
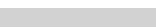
Android: See page 51.

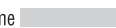
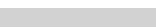
iPhone/iPad: See page 52.

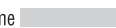
<input type="checkbox"/>	CTRL W/SMARTPHONE						
							
<table border="1"> <tr> <td>SSID</td> <td></td> </tr> <tr> <td>Password</td> <td></td> </tr> <tr> <td>Device Name</td> <td></td> </tr> </table>		SSID		Password		Device Name	
SSID							
Password							
Device Name							

4 Operate the camcorder by the smartphone.

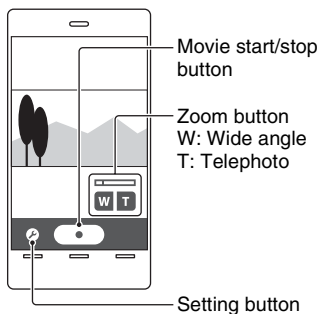

⚡ Notes

- Live view images may not be displayed smoothly, depending on the smartphone performance and/or transmission conditions.
- Movies cannot be recorded on a smartphone.

💡 Tips

- If you assign [SMARTPHONE CONNECT] to an ASSIGN button, you can start [CTRL W/ SMARTPHONE] by pressing that ASSIGN button when the shooting screen is displayed (p. 62).
- To start [CTRL W/SMARTPHONE] in Slow & Quick Motion mode, perform one-touch connection with an NFC-compatible smartphone, or press the ASSIGN button to which [SMARTPHONE CONNECT] is assigned.

Functions operable by [CTRL W/ SMARTPHONE]

- Recording start/stop
- Touch focus
Available when the FOCUS switch on the camcorder is set to MAN.
- Zoom
The zoom speed is fixed.

- Iris adjustment

While the smartphone is connected to the camcorder, CLOSE cannot be selected.

⚡ Notes

- You cannot perform other operations during touch focus.
- Zoom speed operates according to the [SPEED ZOOM] setting.

Transferring images to a smartphone

You can transfer MP4 movies recorded on the camcorder with [MP4 SIMUL REC], or still images created from high definition image quality (HD) images, to display on a smartphone.

1 Select the memory card on which the images to be transferred are recorded on the VISUAL INDEX screen.

2 Press the MENU button, then select  (NETWORK SET) → [SEND TO SMARTPHONE] with the SEL/PUSH EXEC dial.

3 Connect the smartphone to the camcorder, using the information that appears on the screen when the camcorder is ready to be connected.

The connection method will depend on the type of smartphone.

Android: See page 51.

iPhone/iPad: See page 52.

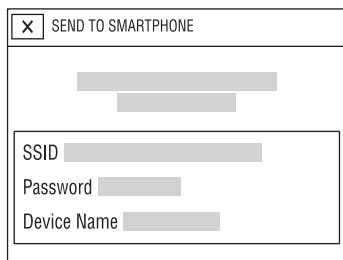

Notes

- Images to be transferred cannot be checked beforehand.
- You cannot transfer high definition image quality (HD) images.
- Once the connection is established, the recording media cannot be selected.
- The smartphone cannot be connected to the camcorder when [AIRPLANE MODE] is set to [ON]. Set [AIRPLANE MODE] to [OFF] (p. 98).
- Images in external media devices cannot be transferred.

Tips

- If you assign [SMARTPHONE CONNECT] to an ASSIGN button, you can start [SEND TO SMARTPHONE] by pressing that ASSIGN button when the VISUAL INDEX screen is displayed (p. 62).

Connecting without using the NFC function (Android)

- 1 Start "PlayMemories Mobile" on your smartphone.

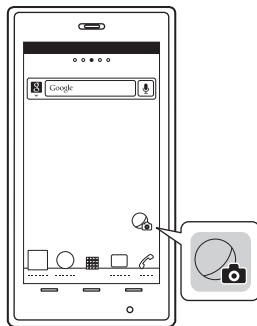

- 2 Select the SSID displayed on the camcorder.

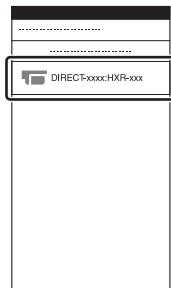

3 Input the password displayed on the camcorder (first time only).

The smartphone connects to the camcorder.

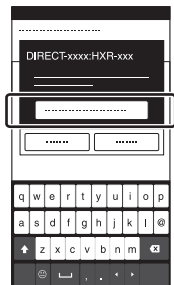

2 Input the password displayed on the camcorder (first time only).

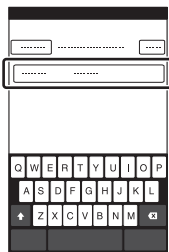

3 Confirm connection to the SSID displayed on the camcorder.

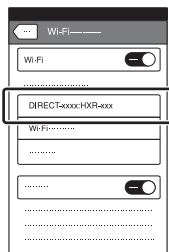

Connecting without using the NFC function (iPhone/iPad)

1 Select [Settings] on the iPhone or iPad, then select [Wi-Fi] and the SSID (displayed on the camcorder).

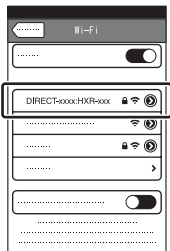

4 Return to the Home screen, then start "PlayMemories Mobile."

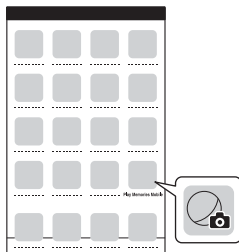

Customizing the picture quality (Picture profile)

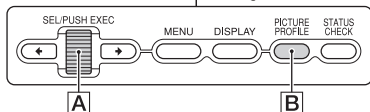
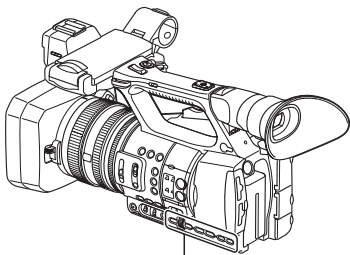

You can customize the picture quality by adjusting picture profile items such as [GAMMA] and [DETAIL]. You can make adjustments for the time of day, weather conditions, or just personal preference.

Connect your camcorder to a TV or monitor, and adjust the picture quality while observing the picture on the TV or monitor screen.

Picture quality settings for different recording conditions have been stored in [PP1] through [PP6] as default settings.

Notes

- [PP4] may be set for the picture profile by default, depending on the country or region.

Picture profile number	Example setting
PP1	Example settings of a color tone with [STANDARD] gamma
PP2	Example settings of a color tone with [STILL] gamma

Picture profile number	Example setting
PP3	Example settings of natural color tone with [ITU-709] gamma
PP4	Example settings of a color tone that is faithful to [ITU-709]
PP5	Example settings of pictures recorded on cinema color negative film
PP6	Example settings of pictures screened with cinema color print film

1 Press the **PICTURE PROFILE** button **B** during standby.

2 Select a picture profile number with the **SEL/PUSH EXEC** dial **A**, then press the dial.

You can record with the settings of the selected picture profile.

3 Select [OK] with the **SEL/PUSH EXEC** dial **A**, then press the dial.

To cancel the picture profile recording

Select [OFF] in step 2 with the SEL/PUSH EXEC dial **A**, then press the dial.

To change the picture profile

You can change the settings stored in [PP1] through [PP6].

- 1 Press the **PICTURE PROFILE** button **B**.

Useful functions (Continued)

- ② Select the PICTURE PROFILE number with the SEL/PUSH EXEC dial **[A]**, then press the dial.
- ③ Select [SETTING] with the SEL/PUSH EXEC dial **[A]**, then press the dial.
- ④ Select an item to be adjusted with the SEL/PUSH EXEC dial **[A]**, then press the dial.
- ⑤ Adjust the picture quality with the SEL/PUSH EXEC dial **[A]**, then press the dial.
- ⑥ Repeat steps ④ and ⑤ to adjust other items.
- ⑦ Select [↩ RETURN] with the SEL/PUSH EXEC dial **[A]**, then press the dial.
- ⑧ Select [OK] with the SEL/PUSH EXEC dial **[A]**, then press the dial.
A picture profile indicator appears.

BLACK LEVEL

To set the black level.

Item	Description and settings
	Sets the black level. -15 to +15

GAMMA

To select a gamma curve.

Item	Description and settings
[STANDARD]	Standard gamma curve
[STILL]	Gamma curve to create the tone of a still image.
[CINEMATONE1]	Gamma curve 1 for producing tone of film camera images
[CINEMATONE2]	Gamma curve 2 for producing tone of film camera images
[ITU709]	Gamma curve that corresponds to ITU-709. Gain in low intensity area: 4.5

🔊 Notes

- There is no still image shooting mode on the camcorder.

BLACK GAMMA

To correct gamma in low intensity area.

Item	Description and settings
[RANGE]	Selects a correcting range. HIGH / MIDDLE / LOW
[LEVEL]	Sets the correcting level. -7 (maximum black compression) to +7 (maximum black stretch)

Useful functions (Continued)

KNEE

To set knee point and slope for video signal compression to prevent over-exposure by limiting signals in high intensity areas of the subject to the dynamic range of your camcorder.

When selecting [STANDARD] or [STILL] in [GAMMA], [KNEE] is set to off if [MODE] is set to [AUTO]. To use functions in [KNEE], set [MODE] to [MANUAL].

Item	Description and settings
[MODE]	Selects a mode either automatic or manual. [AUTO] : Sets the knee point and slope automatically. [MANUAL] : Sets the knee point and slope manually.
[AUTO SET]	Sets the maximum point and sensitivity in the automatic mode. [MAX POINT] : Sets the maximum point. 90% to 100% [SENSITIVITY] : Sets the sensitivity. HIGH / MIDDLE / LOW
[MANUAL SET]	Sets the knee point and slope manually. [POINT] : Sets the knee point. 75% to 105% [SLOPE] : Sets the knee slope. -5 (gentle) to +5 (steep) [KNEE] is set to off when you set to +5.

COLOR MODE

To set type and level of colors.

Item	Description and settings
[TYPE]	Selects a type of colors. [STANDARD] : Suitable colors when [GAMMA] is set to [STANDARD]. [STILL] : Suitable colors when [GAMMA] is set to [STILL]. [CINEMATONE1] : Film camera image-like colors good with [GAMMA] set to [CINEMATONE1]. [CINEMATONE2] : Film camera image-like colors good with [GAMMA] set to [CINEMATONE2]. [PRO] : Similar color tones to the standard image quality of Sony professional cameras (when combined with ITU-709) [ITU709 MATRIX] : Colors corresponding to ITU-709
[LEVEL]	Sets a level of coloring difference between the standard color and the selected color, when you set [TYPE] to a setting other than [STANDARD]. 1 (close to color settings of [STANDARD]) to 8 (color settings of the selected type)

COLOR LEVEL

To set the color level.

Item	Description and settings
	-8: black and white, -7 (light) to +7 (dark)

COLOR PHASE

To set the color phase.

Item	Description and settings
	-7 (greenish) to +7 (reddish)

COLOR DEPTH

To set the color depth for each color phase.

This function is more effective for chromatic colors and less effective for achromatic colors. The color looks deeper as you increase the setting value to more positive side, and lighter as you decrease the value to more negative side. This function is effective even if you set [COLOR LEVEL] to [-8] (black and white).

Item	Description and settings
[R]	-7 (light red) to +7 (deep red)
[G]	-7 (light green) to +7 (deep green)
[B]	-7 (light blue) to +7 (deep blue)
[C]	-7 (light cyan) to +7 (deep cyan)
[M]	-7 (light magenta) to +7 (deep magenta)
[Y]	-7 (light yellow) to +7 (deep yellow)

WB SHIFT

To set items for the white balance shift.

Items you can adjust differ depending on the filter type.

Item	Description and settings
[FILTER TYPE]	Selects a color filter type for the white balance shift. [LB-CC] : Film type (color conversion and correction) [R-B] : Video type (correction of R and B levels)
[LB][COLOR TEMP]]	Sets a color temperature offset value. -9 (bluish) to +9 (reddish)
[CC][MG/GR]]	Sets a color correct offset value. -9 (greenish) to +9 (magentish)
[R GAIN]	Sets an R level. -9 (low R level) to +9 (high R level)
[B GAIN]	Sets a B level. -9 (low B level) to +9 (high B level)

Useful functions (Continued)

DETAIL

To set items for the detail.

Item	Description and settings
[LEVEL]	Sets the detail level. -7 to +7
[MANUAL SET]	[ON/OFF] : Turns on and off the manual detail adjustment. Set to [ON] to enable the manual detail adjustment (automatic optimization will not be performed).
	[V/H BALANCE]: Sets the vertical (V) and horizontal (H) balance of DETAIL. -2 (off to the vertical (V) side) to +2 (off to the horizontal (H) side)
	[B/W BALANCE]: Selects the balance of the lower DETAIL (B) and the upper DETAIL (W). TYPE1 (off to the lower DETAIL (B) side) to TYPE5 (off to the upper DETAIL (W) side)
	[LIMIT] : Sets the limit level of DETAIL. 0 (Low limit level: likely to be limited) to 7 (High limit level: not likely to be limited)
	[CRISPENING] : Sets the crispening level. 0 (shallow crispening level) to 7 (deep crispening level)
	[HI-LIGHT DETAIL]: Sets the DETAIL level in the high intensity areas. 0 to 4

COPY

To copy the settings of the picture profile to another picture profile number.

RESET

To reset the picture profile to the default setting.

To copy the picture profile setting to another picture profile number

See page 53 for the location of the buttons.

- ① Press the PICTURE PROFILE button **[B]**.
- ② Select the picture profile number that you want to copy from with the SEL/PUSH EXEC dial **[A]**, then press the dial.
- ③ Select [SETTING] → [COPY] with the SEL/PUSH EXEC dial **[A]**, then press the dial.
- ④ Select the number of the picture profile that you want to copy to with the SEL/PUSH EXEC dial **[A]**, then press the dial.
- ⑤ Select [YES] → [**↩** RETURN] → [OK] with the SEL/PUSH EXEC dial **[A]**.

To reset the picture profile settings

You can reset the picture profile settings by each picture profile number. You cannot reset all picture profile settings at once. See page 53 for the location of the buttons.

- ① Press the PICTURE PROFILE button **[B]**.
- ② Select the picture profile number that you want to reset with the SEL/PUSH EXEC dial **[A]**, then press the dial.
- ③ Select [SETTING] → [RESET] → [YES] → [**↩** RETURN] → [OK] with the SEL/PUSH EXEC dial **[A]**.

Setting time data

The camcorder records movies accompanied by time data, such as time code and user bit.

Presetting the time code

- ① Press the MENU button, select **00:00** (TC/UB SET) → [TC PRESET] with the SEL/PUSH EXEC dial, then press the dial.
- ② Select [PRESET] with the SEL/PUSH EXEC dial, then press the dial.
- ③ Select the first 2 digits with the SEL/PUSH EXEC dial, then press the dial. You can set the time code within the following range.
NTSC model:
00:00:00:00 - 23:59:59:29
 - When setting 24p, you can set the last 2 time code digits of the frames in multiples of 4, between 0 and 23.
 PAL model:
00:00:00:00 - 23:59:59:24
- ④ Set other digits by repeating step ③.
- ⑤ Select [OK] with the SEL/PUSH EXEC dial, then press the dial.

To reset the time code

You can reset the time code (00:00:00:00). Select [RESET] in step ② of “Presetting the time code.”

To reset the time code using the Wireless Remote Commander

You can reset the time code (00:00:00:00) also by pressing the TC RESET button on the Wireless Remote Commander.

Presetting the user bit

- ① Press the MENU button, select **00:00** (TC/UB SET) → [UB PRESET] with the SEL/PUSH EXEC dial, then press the dial.
- ② Select [PRESET] with the SEL/PUSH EXEC dial, then press the dial.
- ③ Select the first 2 digits with the SEL/PUSH EXEC dial, then press the dial.
- ④ Set other digits by repeating step ③.

Useful functions (Continued)

- ⑤ Select [OK] with the SEL/PUSH EXEC dial, then press the dial.

To reset the user bit

You can reset the user bit (00 00 00 00). Select [RESET] in step ② of “Presetting the user bit.”

Recording with the Slow & Quick Motion function

By recording with a frame rate that is different from the playback frame rate, you can record images to be played back as slow motion or quick motion images. The images recorded with the Slow & Quick Motion function will appear smoother than slow or fast-forward playback of images recorded at normal speed.

You can use the Slow & Quick Motion function with high definition image quality (HD) only.

Playback speed

The playback speeds based on the recording format and frame rate setting are as follows.

NTSC model

FRAME RATE	REC FORMAT		
	1080/24p	1080/30p	1080/60p
60	40% slow	50% slow	100% (standard)
30	80% slow	100% (standard)	200% quick
15	160% quick	200% quick	400% quick
8	300% quick	375% quick	750% quick
4	600% quick	750% quick	1500% quick
2	1200% quick	1500% quick	3000% quick
1	2400% quick	3000% quick	6000% quick

PAL model

FRAME RATE	REC FORMAT	
	1080/25p	1080/50p
50	50% slow	100% (standard)
25	100% (standard)	200% quick
12	208% quick	417% quick
6	417% quick	833% quick
3	833% quick	1667% quick
2	1250% quick	2500% quick
1	2500% quick	5000% quick

S&Q button

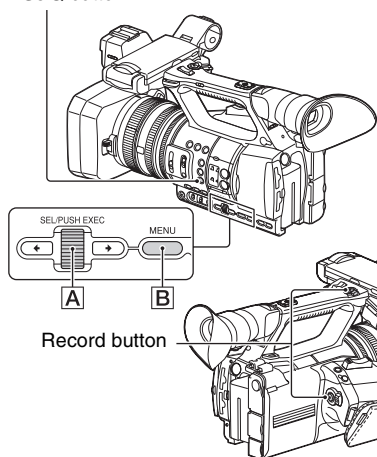

Notes

- S&Q MOTION recording is not available when [SIMUL/RELAY REC] is set to [MP4 SIMUL REC].
- You must use the SD card Class 10 or faster for Slow & Quick Motion recording. You cannot record on “Memory Stick PRO Duo” media.
- When recording with the Quick Motion recording function, your camcorder may continue recording for some time (approximately 30 seconds at most) after you press the button to stop recording. Do not operate your camcorder while the [REC] indicator is flashing on the screen, and wait till it turns to [STBY].

- After you press the button to stop recording, your camcorder continues recording till it completes writing of the minimum unit of data (0.5 seconds of replay time).

Preparation

You must set the recording format and frame rate.

- ① Press the MENU button **[B]**.
- ② Select **[CAMERA SET]** → **[S&Q MOTION]** → **[REC FORMAT]** with the SEL/PUSH EXEC dial **[A]**.
- ③ Select a recording format.
You can select one from 1080/60p PS, 1080/30p FX/FH, 1080/24p FX/FH (NTSC model), or 1080/50p PS or 1080/25p FX/FH (PAL model).
- ④ Select **[FRAME RATE]** with the SEL/PUSH EXEC dial **[A]**, and set a desired frame rate.
You can select one from 60 fps, 30 fps, 15 fps, 8 fps, 4 fps, 2 fps, or 1 fps (NTSC model) or 50 fps, 25 fps, 12 fps, 6 fps, 3 fps, 2 fps, or 1 fps (PAL model).
- ⑤ Select **[↵ RETURN]** → **[↵ RETURN]**.

To record with the Slow & Quick Motion function

Press the S&Q button, then the record button.

Recording starts.

To stop Slow & Quick Motion recording

Press the record button again.

To change the frame rate setting

Hold the S&Q button down for about 1 second, then change the value with the SEL/PUSH EXEC dial.

Holding the S&Q button down again for about 1 second restores the previous setting.

To cancel Slow & Quick Motion recording

Press the S&Q button or the MENU button during standby.

Notes

- When you are recording with a slow frame rate, the camcorder may continue recording for a few more seconds after you press the record button to stop recording.
- You cannot change the frame rate during Slow & Quick Motion recording. To change the frame rate, stop current Slow & Quick Motion recording.
- The time code is recorded in the [REC RUN] mode during Slow & Quick Motion recording (p. 97).
- The Slow & Quick Motion mode is canceled automatically when the POWER switch is set to OFF, but the frame rate setting is retained.
- You can record sound only at 100% (standard).
- You cannot use the Slow & Quick Motion function for the simultaneous recording.
- You cannot use the Slow & Quick Motion function with the standard image quality (DV).

Reviewing the most recently recorded scene (Last Scene Review)

You can review the most recently recorded scene on the LCD screen.

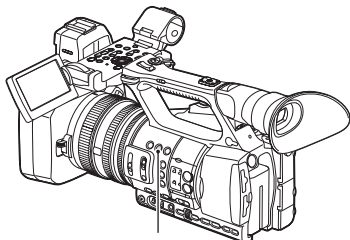

LAST SCENE button

Right after you stop recording, press the **LAST SCENE** button.

The camcorder plays from the top to the end of the most recently recorded scene, then returns to standby mode.

To stop reviewing the last scene

Press the **LAST SCENE** button during playback. The camcorder returns to standby mode.

Notes

- If you edit the movie or remove the recording media after you stop recording, the Last Scene Review function may not work correctly.

Tips

- You can assign this function to an **ASSIGN** button (p. 62).

Assigning the functions to the **ASSIGN** buttons

Some functions can be assigned to the **ASSIGN** buttons for use. You can assign a single function to any one of the **ASSIGN** 1 to 6 buttons.

See “Menu items” (p. 83) on the function of each item.

Default function of each **ASSIGN** button

- **ASSIGN 1: PEAKING** (p. 93)
- **ASSIGN 2: HISTOGRAM** (p. 93)
- **ASSIGN 3: IRIS PUSH AUTO** (p. 38)
- **ASSIGN 4: LAST SCENE REVIEW** (p. 61)
- **ASSIGN 5: ZEBRA** (p. 93)
- **ASSIGN 6: FOCUS MAGNIFIER** (p. 33)

Functions you can assign to the **ASSIGN** buttons

- - (no function)
- **FOCUS MAGNIFIER** (p. 33)
- **LAST SCENE REVIEW** (p. 61)
- **WB PRESET** (p. 41)
- **AE SHIFT** (p. 87)
- **STEADYSHOT** (p. 87)
- **IRIS PUSH AUTO** (p. 38)
- **SPOT METER/FOCUS** (p. 88)
- **SPOT METER** (p. 88)
- **SPOT FOCUS** (p. 33)
- **FACE DETECTION** (p. 34)
- **COLOR BAR** (p. 88)
- **HISTOGRAM** (p. 93)
- **ZEBRA** (p. 93)
- **PEAKING** (p. 93)
- **MARKER** (p. 94)
- **CAMERA DATA DISPLAY** (p. 95)
- **AUDIO LEVEL DISPLAY** (p. 95)
- **REC LAMP[F]** (p. 100)
- **REC LAMP[R]** (p. 100)
- **VISUAL INDEX** (p. 64)
- **AUTO MODE SET** (p. 46)
- **SCENE SELECTION SET** (p. 47)

• SMARTPHONE CONNECT (p. 50)

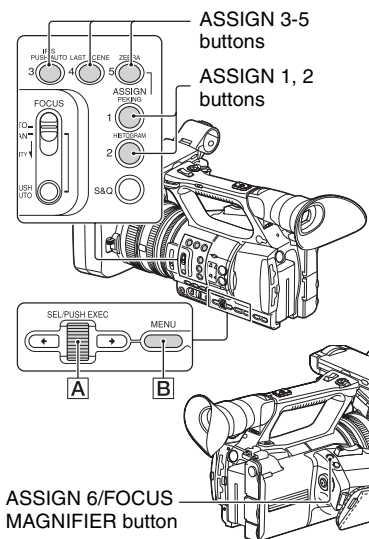

1 Press the MENU button **B**.

2 Select **OTHERS** → [ASSIGN BUTTON] with the SEL/PUSH EXEC dial **A**.

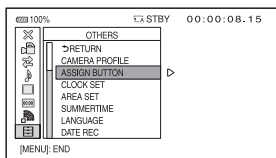

3 Select the ASSIGN button to which you want to assign a function with the SEL/PUSH EXEC dial **A**, then press the dial.

- [-----] appears if no function is assigned to the ASSIGN button.

4 Select the function that you want to assign with the SEL/PUSH EXEC dial **A**, then press the dial.

5 Select [OK] with the SEL/PUSH EXEC dial **A**, then press the dial.

Playback

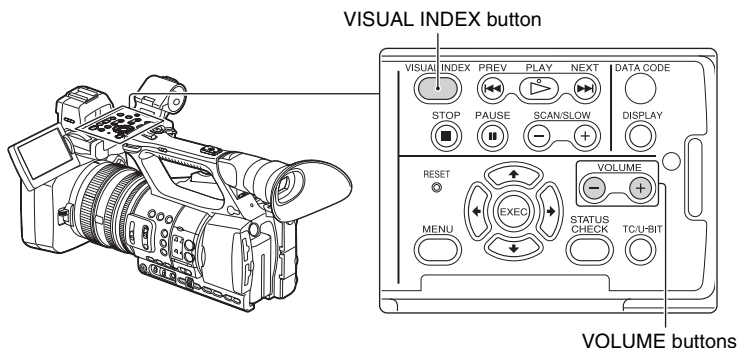

Playing back movies

- Slide the POWER switch, START/STOP button to ON while pressing the green button.

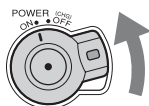

- Press the VISUAL INDEX button.

The VISUAL INDEX screen appears after a few seconds.

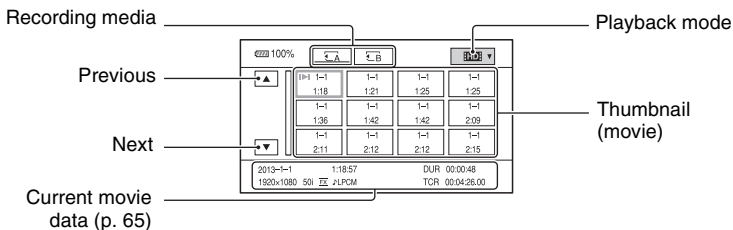

- You can turn on or off the date and time display on the thumbnails by pressing the DISPLAY button.

3 Play back movies.

- ① Touch the recording media you want to play back.

⏪ A : Memory card A

⏪ B : Memory card B

- ② Touch the playback mode, and select the desired image quality of movies.

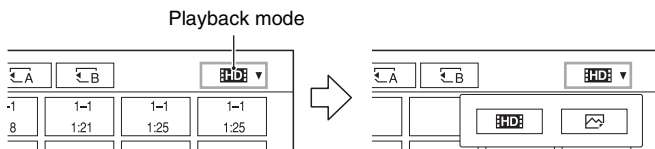

- ③ Touch twice the thumbnail of the movie you want to play back.

You can also select the movie to be played back by pressing ◀/▶/⏪/⏩ buttons followed by pressing the EXEC button.

The first touch of the thumbnail will show the information on the movie at the lower part of the LCD screen.

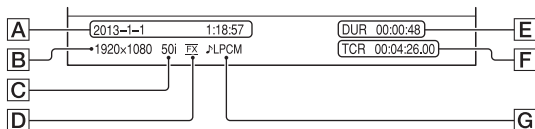

A Date and time of recording started

B Resolution

C Frame rate

D Recording mode

E Duration

F Time code of recording started

Time code will not be displayed correctly when you play back recording media with no time code, or recording media with time code that your camcorder does not support.

G LPCM recording

Appears when audio is recorded in Linear PCM.

- **II** appears with the movie that has been most recently played back or recorded. If you touch the movie with **II**, you can continue playback from the previous time.

Playback (Continued)

Your camcorder starts playing the selected movie.

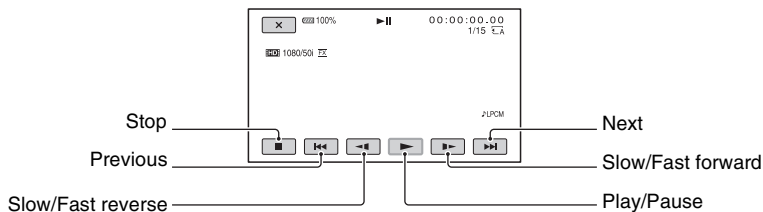

Notes

- If you touch the thumbnail and press the PLAY button, the most recently recorded or played scene is played back.
- Movie files recorded in DV mode can only be played back when the camcorder is set to DV mode.
- MP4 movies recorded with [MP4 SIMUL REC] cannot be played back.

Tips

- When playback from the selected movie reaches the last movie, the screen returns to the VISUAL INDEX screen.
- Touch ◀|▶ during pause to play back movies slowly.
- As you repeat touching ◀◀/▶▶ during playback, movies are played back as fast as about 5 times → about 10 times → about 30 times → about 60 times.
- Reduced-size images which enable you to view many movies at the same time on the VISUAL INDEX screen are called “thumbnails.”
- You can operate playback using the PREV/PLAY/NEXT/STOP/PAUSE/SCAN/SLOW buttons on the camcorder.
- In DV mode, SCAN/SLOW buttons are disabled.
- In DV mode, fast forward and fast reverse during playback are 5 times faster than normal playback speed.
- When you play back a DV file recorded with a camcorder other than this camcorder, the F value may not be displayed correctly.

To adjust the volume

Adjust the volume with the VOLUME buttons.

To return to the recording mode

Press the VISUAL INDEX button.

On playing back movies

- Movies recorded using this camcorder may not be played back normally on devices other than this camcorder. Also, movies recorded on other devices may not play back properly on this camcorder.
- Standard definition image quality (DV) movies recorded on SD memory cards cannot be played on A/V devices of other manufacturers.

Playing back still images

1 Touch the recording media you want to view on the VISUAL INDEX screen.

⏪ A : Memory card A

⏪ B : Memory card B

2 Touch the playback mode, then select (still image).

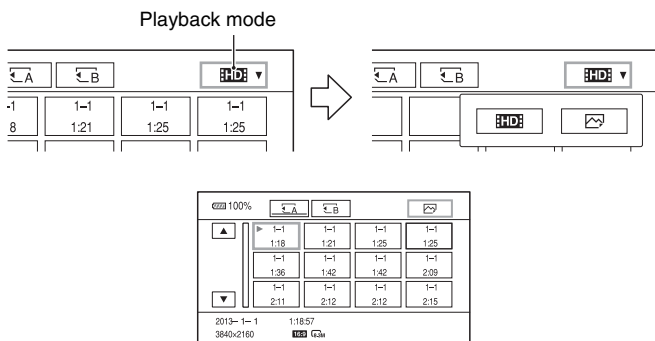

3 Touch twice the thumbnail of the still image you want to view.

The first touch of the thumbnail will show the information on the still image at the lower part of the LCD screen.

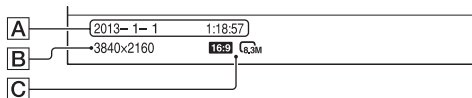

A Date and time of recording

B Resolution

C Image size

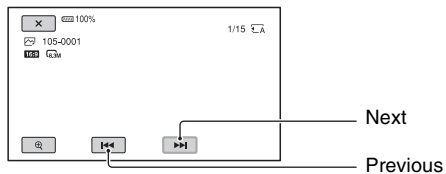

Playback (Continued)

Your camcorder displays the selected still image.



To enlarge

Touch  (playback zoom) when playing back a still image.

You can adjust the zoom with  / , or with the power zoom lever.

When you touch the enlarged image, the touched point will be displayed at the center of the screen.

Changing/checking the settings in your camcorder

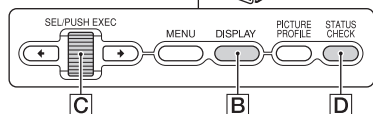
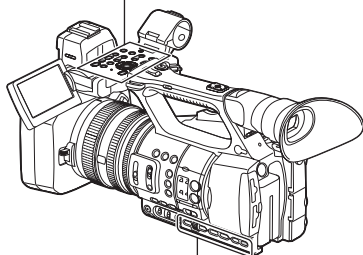
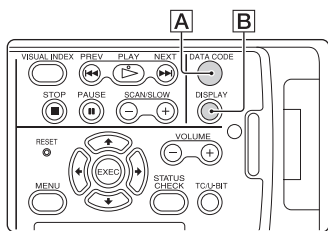

Changing the screen display

You can display information such as time code, etc., on the image.

Press the **DISPLAY** button (B).

The screen indicators turn on (displayed) and off (not displayed) as you press the button.

In the recording mode, the screen changes in the order, detailed display → simple display → no display with each press of the button.

Tips

- You can display the screen indicators during playback on a TV. Select [ALL OUTPUT] of [DISPLAY OUTPUT] (p. 96).

Displaying recording data (Data code)

You can display information, including date, time and camera data automatically stored during recording on the screen during playback.

Press the **DATA CODE** button (A) during playback or pause.

The screen changes in the order, date and time display → camera data display → no display with each press of the button.

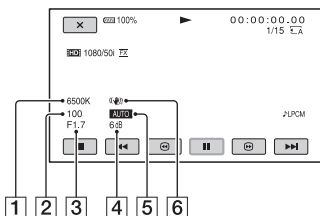

1 White balance

PWB will appear during the playback of still images or movies recorded with [MANU WB TEMP].

2 Shutter speed

3 Iris

4 Gain

5 Exposure

AUTO appears during playback of the movie recorded with the iris, gain or shutter speed automatically adjusted.

MANUAL appears during playback of the movie recorded with the iris, gain or shutter speed manually adjusted.

6 SteadyShot

Changing/checking the settings in your camcorder (Continued)

Notes

- When you play back the memory card on other devices, the camera data may be displayed incorrectly. Confirm the correct camera data on your camcorder.

Checking the settings in your camcorder (Status check)

You can check the settings of the following items.

- Audio setup (p. 91)
- Output signal setup (p. 89)
- Functions assigned to the ASSIGN buttons (p. 62)
- Camera setup (p. 86)
- Record button setup (p. 29)
You can check the record button setting.

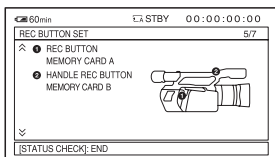

- Recording media information
You can check the estimated used and free spaces.

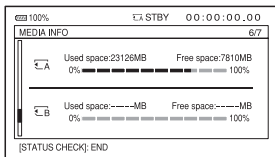

- Battery Info
You can check the remaining capacity of the attached battery.

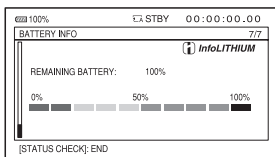

- Press the STATUS CHECK button **D**.

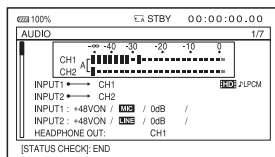

- Turn the SEL/PUSH EXEC dial **C** until a desired display shows up on the LCD screen.

AUDIO → OUTPUT → ASSIGN → CAMERA → REC BUTTON SET → MEDIA INFO → REC BUTTON INFO

Setup items are displayed according to the settings of the camcorder when it is turned on.

To hide the display

Press the STATUS CHECK button **D**.

Connecting a monitor or a TV

Playback image quality depends on the type of monitor or TV, or the jacks used to make the connection.

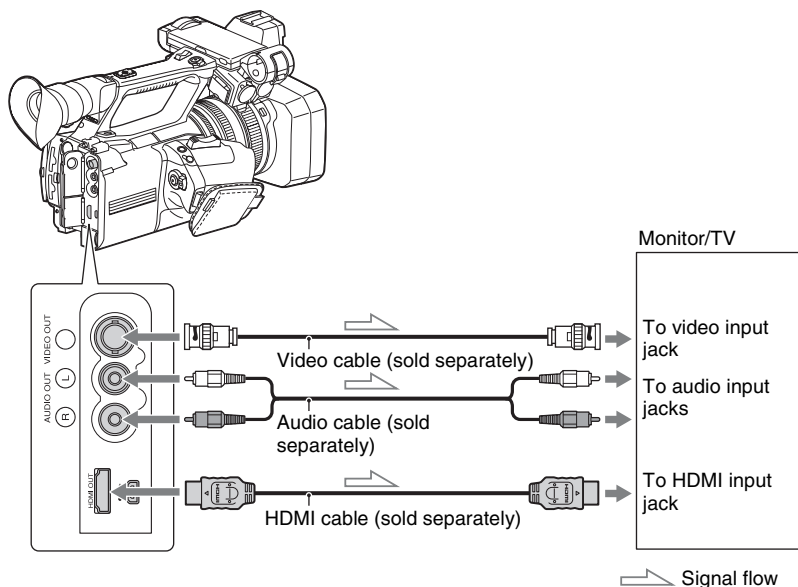

The HDMI OUT and VIDEO OUT jacks cannot output image signals simultaneously. The output resolution of the VIDEO OUT jack is 480i (NTSC model) or 576i (PAL model).

Connecting a monitor or a TV (Continued)

Output resolution

Output resolution depends on the settings of [HDMI].

NTSC model

HD/DV	[HDMI] setting	Output resolution	
		HDMI OUT	VIDEO OUT
HD	1080p/480i	1080p	No output
	720p/480i	720p	No output
	1080i/480i	1080i	No output
	480p	480p	No output
	480i	480i	No output
DV	1080p/480i	480i	No output
	720p/480i	480i	No output
	1080i/480i	480i	No output
	480p	480p	No output
	480i	480i	No output

PAL model

HD/DV	[HDMI] setting	Output resolution	
		HDMI OUT	VIDEO OUT
HD	1080p/576i	1080p	No output
	720p/576i	720p	No output
	1080i/576i	1080i	No output
	576p	576p	No output
	576i	576i	No output
DV	1080p/576i	576i	No output
	720p/576i	576i	No output
	1080i/576i	576i	No output
	576p	576p	No output
	576i	576i	No output

Notes

- It is recommended that you use an authorized cable with HDMI logo or a Sony HDMI cable.
- Images are not output from the HDMI OUT jack of your camcorder, if copyright protection signals are recorded in the movies.
- Images and sounds may not be reproduced correctly on some monitors or TVs.
- Do not connect the output jacks of the camcorder with the output jacks of the monitor or TV. A malfunction may be caused.
- When the frame rate in [HDMI] REC FORMAT is set to 24p or 30p (NTSC model) or 25p (PAL model), the output signal is converted to interlace or progressive through pull-down conversion.

- If you display the edit screen while outputting signals to a monitor or TV, the menu may not be displayed correctly.
- This camcorder is not compatible with “BRAVIA” sync.

Protecting movies and still images (Protect)

Protect movies and still images to avoid deleting them by mistake.

1 Press the MENU button when the VISUAL INDEX screen is displayed.



2 Select  (EDIT) → [PROTECT] with the SEL/PUSH EXEC dial.

3 Touch the movies or still images to be protected.

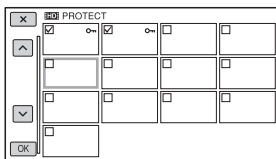
✓ is displayed on the selected images.



- Press and hold the image down to preview the image. Touch  to return to the previous screen.
- You can select up to 100 images at one time.

4 Touch  →  → .

To undo the protection of movies and still images

Touch the movie or still image marked with ✓ in step 3.
✓ disappears.

Notes

- You cannot protect standard image quality (DV) images.

Dividing a movie

You can divide a movie at a designated point.

1 Press the MENU button while playing back movies.

2 Select  (EDIT) → [DIVIDE] with the SEL/PUSH EXEC dial.

3 Touch  at the point where you want to divide.

After you select the point with , make fine adjustment with these buttons.

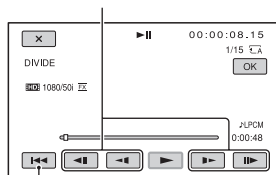

Returns to the beginning of the selected movie.

4 Touch  → .

Notes

- You cannot restore movies once they are divided.
- Do not remove the battery pack, the AC Adaptor or the recording media that contains the movies from your camcorder during the operation. It may damage the recording media.
- A slight difference may occur from the point where you touch  and the actual dividing point, as your camcorder selects the dividing point based in about half-second increments.
- You cannot divide standard image quality (DV) images.

Deleting movies and still images

Tips

- Only simple editing is available on this camcorder. Use commercially available editing software for more advanced editing.

You can free media space by deleting movies and still images from recording media.

Notes

- You cannot restore images once they are deleted.
- Do not remove the battery pack, the AC Adaptor or the recording media that contains the movies or still images from your camcorder during the operation. It may damage the recording media.
- You cannot delete protected movies and still images. Undo the protection of the movies and still images, before you try to delete them (p. 74).
- Save important movies and still images in advance.
- You cannot delete MP4 movies on the camcorder. To delete MP4 movies, save important images to a computer, then perform [MEDIA FORMAT] on the camcorder (p. 78).
- You cannot delete standard image quality (DV) images.

Tips

- To delete all data recorded on the recording media and recover all the recordable space of the media, format the media (p. 78).

1 Press the **MENU** button when the **VISUAL INDEX** screen is displayed.

2 Select  (**EDIT**) → [**DELETE**] with the **SEL/PUSH EXEC** dial.

3 Touch the movies or still images to be deleted.

✓ is displayed on the selected images.

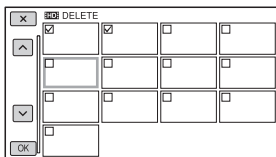

- Press and hold the image down to preview the image. Touch to return to the previous screen.
- You can select up to 100 images at one time.
- appears at the upper right corner on the thumbnail of protected images.
- No check box appears on the thumbnail of protected images.

4 Touch → → .

Copying movies and still images

You can copy images recorded on a memory card inserted in the memory card slot A or B, between the memory card in slot A and B or to external recording media. Insert the memory card to your camcorder before the operation.

ⓘ Notes

- When you save images on the memory card for the first time, press the MENU button, then select (OTHERS) → [REPAIR IMAGE DB FILE] → [MEMORY CARD A] or [MEMORY CARD B], to create the image database file.
- Connect your camcorder to the wall outlet (wall socket) using the supplied AC Adaptor to prevent your camcorder from running out of power during the operation.
- You cannot copy standard image quality (DV) images.

💡 Tips

- The original movies and still images will not be deleted after copying.

1 Press the MENU button when the VISUAL INDEX screen is displayed.

2 Select (EDIT) → [COPY] with the SEL/PUSH EXEC dial.

3 Select the recording media to copy from and to.

4 Select [Multiple Images].

5 Select the image type ([MOVIE], [PHOTO]).

6 Touch the movies or still images to be copied.

✓ is displayed on the selected image.

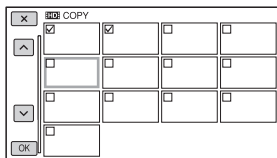

- Press and hold the image down to preview the image. Touch [X] to return to the previous screen.
- You can select up to 100 images at one time.

7 Touch [OK] → [OK] → [OK].

To copy all movies or still images

Select [All] in step 4, and the image type in step 5.

Capturing still images from a movie

You can save a selected frame from a recorded movie as a still image.

1 Press the MENU button while playing back movies.

2 Select [EDIT] → [PHOTO CAPTURE] with the SEL/PUSH EXEC dial.

3 Touch [II] at the point where you want to capture.

After you select the point with [II], make fine adjustment with these buttons.

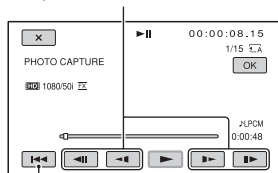

Returns to the beginning of the selected movie.

4 Touch [OK].

The captured still image is saved on the same recording media as that of the playing movie. When capturing is finished, the screen returns to pause.

Notes

- Still images cannot be created from a movie recorded in the standard image quality (DV).
- The image size of still images is fixed to [2.1M].
- The recording media where you want to save still images should have enough free space.
- The recording date and time of captured still images is the same as the recording date and time of the movies.

Capturing still images from a movie (Continued)

- If the movie you are capturing from has no data code, the recording date and time of the still image will be the date and time you captured from the movie.

Formatting the recording media

Formatting deletes all data from the recording media to recover recordable free space.



ⓘ Notes

- Connect your camcorder to the wall outlet (wall socket) using the supplied AC Adaptor to prevent your camcorder from running out of power during the operation.
- To avoid the loss of important images, you should save them before formatting the recording media.
- Protected movies and still images are also deleted.

1 Press the **MENU** button.

2 Select  (OTHERS) → [MEDIA FORMAT] with the SEL/PUSH EXEC dial.

3 Select the recording media to be formatted.

4 Touch  → .

ⓘ Notes

- While [Executing...] is displayed, do not turn off the camcorder, do not operate any buttons on the camcorder, disconnect the AC Adaptor, or remove the recording media from your camcorder. (The access lamp is lit or flashing while formatting recording media.)

Preventing data on recording media from being recovered

Unintelligible data can be written on recording media. Thus, it may become more difficult to recover any original data. It is impossible to delete all data completely, even if you format the recording media. Therefore, when you dispose of or transfer the recording media, it is recommended that you perform the [Empty] operation.

🔔 Notes

- If you perform this operation, all stored data are deleted. To avoid the loss of important images, you should save them before the operation.
- You cannot perform this operation unless you connect the AC Adaptor to the wall outlet (wall socket).
- Disconnect all cables except the AC Adaptor. Do not disconnect the AC Adaptor during the operation.
- Do not apply any vibrations or shocks to your camcorder during this operation.

1 Connect your camcorder to the wall outlet (wall socket) using the AC Adaptor AC-L100C (supplied) (p. 20).

2 Press the MENU button.

3 Select  (OTHERS) → [MEDIA FORMAT] with the SEL/PUSH EXEC dial.

4 Select the recording media to be formatted.

The format screen appears.

5 Touch [Empty] → .

🔔 Notes

- It may take from several minutes to several hours to empty recording media, depending on the capacity. You can check the actual time required on the LCD screen.
- If you stop the operation while [Executing...] is displayed, be sure to complete the operation by performing [MEDIA FORMAT] or emptying before you use the recording media next time.

Repairing the image database file

This function checks the database information and the consistency of movies and still images on the recording media, and repairs if any inconsistencies found.

Notes

- Connect your camcorder to the wall outlet (wall socket) using the supplied AC Adaptor to prevent your camcorder from running out of power during the operation.

1 Press the MENU button.

2 Select  (OTHERS) → [REPAIR IMAGE DB FILE] with the SEL/PUSH EXEC dial.

3 Select the recording media you want to check the database file.

4 Touch .

The database file check starts. Touch  and quit the database file check if no inconsistency is found.

5 Touch  → .

Notes

- If you stop the operation while [Repairing the image database file.] is displayed, be sure to complete the operation as described above before you use the recording media next time.

Operating the menu

You can change various settings or make detailed adjustments using the menu items displayed on the LCD screen.

MENU button

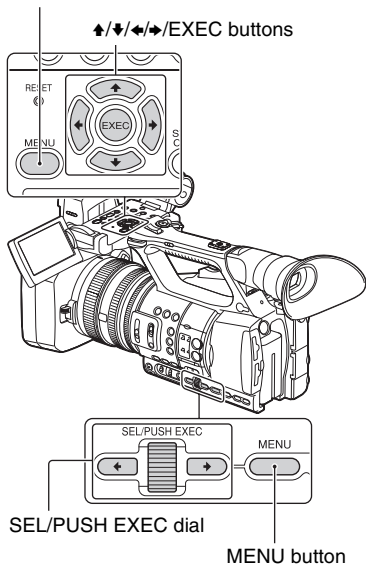

1 Press the MENU button.

The menu screen appears.

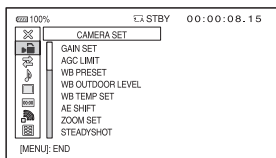

2 Turn the SEL/PUSH EXEC dial until the icon of the desired menu is highlighted, then press the dial to select the menu.

- CAMERA SET (p. 86)
- REC/OUT SET (p. 89)
- AUDIO SET (p. 91)
- DISPLAY SET (p. 93)
- TC/UB SET (p. 97)
- NETWORK SET (p. 98)
- OTHERS (p. 99)
- EDIT (p. 86)

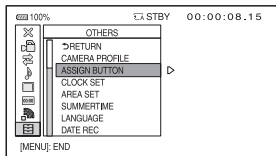

3 Turn the SEL/PUSH EXEC dial until the desired menu item is highlighted, then press the dial to select the item.

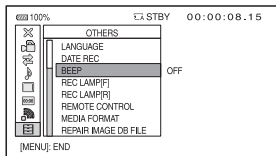

- 4** Turn the SEL/PUSH EXEC dial until the desired setting is highlighted, then press the dial to confirm the setting.

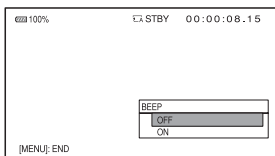





- 5** Press the MENU button to hide the menu screen.

To return to the previous screen, select [↵ RETURN].

Notes

- The available menu items vary depending on the context of your camcorder during recording or playback.
- Items and setting values not available due to other settings, are grayed out.

Tips

- You can operate using the ////EXEC button without using the SEL/PUSH EXEC dial.

Menu items

The function and setting value of each menu item are as follows.
The default settings are marked with ►.

(CAMERA SET) (p. 86)

GAIN SET	H -6dB - 30dB (►18dB) M -6dB - 30dB (►9dB) L -6dB - 30dB (►0dB)
AGC LIMIT	►OFF, 21dB - 0dB
WB PRESET	►OUTDOOR, INDOOR, MANU WB TEMP
WB OUTDOOR LEVEL	-7 - +7 (►0)
WB TEMP SET	2300K - 1500K (►6500K)
AE SHIFT	ON/OFF ►OFF, ON LEVEL -2.0EV - +2.0EV (►0EV)
ZOOM SET	ZOOM TYPE ►OPTICAL ZOOM ONLY, ON[CLEAR IMAGE ZOOM], ON[DIGITAL ZOOM] HANDLE ZOOM 1 - 8 (►3) SPEED ZOOM ►OFF, ON
STEADYSHOT	►STANDARD, ACTIVE, OFF
CONVERSION LENS	►OFF, WIDE CONVERSION

S&Q MOTION	REC FORMAT NTSC model: 1080/60p PS, 1080/30p FX, 1080/30p FH, ►1080/24p FX, 1080/24p FH PAL model: 1080/50p PS, ►1080/25p FX, 1080/25p FH
	FRAME RATE NTSC model: 1fps - 60fps (►60fps) PAL model: 1fps - 50fps (►50fps)
AUTO MODE SET	►AUTO, INTELLIGENT AUTO, SCENE SELECTION
SCENE SELECTION SET	NIGHT SCENE, SUNRISE&SUNSET, FIREWORKS, LANDSCAPE, ►PORTRAIT, SPOTLIGHT, BEACH
SPOT METER/ FOCUS	
SPOT METER	
SPOT FOCUS	
AUTO SLOW SHUTTER	►OFF, ON
FACE DETECTION	ON, ►OFF
COLOR BAR	ON/OFF ►OFF, ON
	TONE ►OFF, ON

Menu items (Continued)



(REC/OUT SET) (p. 89)

REC SET

REC FORMAT

NTSC model:

- ▶1080/60i FX,
- 1080/60i FH,
- 1080/60i HQ,
- 1080/60i LP,
- 1080/60p PS,
- 720/60p FX,
- 720/60p FH,
- 720/60p HQ,
- 1080/30p FX,
- 1080/30p FH,
- 1080/24p FX,
- 1080/24p FH

PAL model:

- ▶1080/50i FX,
- 1080/50i FH,
- 1080/50i HQ,
- 1080/50i LP,
- 1080/50p PS,
- 720/50p FX,
- 720/50p FH,
- 720/50p HQ,
- 1080/25p FX,
- 1080/25p FH

SIMUL/RELAY REC

- ▶OFF, MP4 SIMUL REC,
- SIMULTANEOUS REC, RELAY REC

REC BUTTON SET

▶REC BUTTON:

- ,
- ▶HANDLE REC BUTTON: / REC
- BUTTON: ,
- HANDLE REC BUTTON: / REC BUTTON:
- , HANDLE REC BUTTON:

DV MODE

WIDE REC

- ▶OFF, ON

CANCEL DV MODE

HDMI

NTSC model:

- 1080p/480i,
- 720p/480i,
- ▶1080i/480i,
- 480p, 480i

PAL model:

- 1080p/576i,
- 720p/576i,
- ▶1080i/576i, 576p,
- 576i

DOWN CONVERT

TYPE

- ▶SQUEEZE,
- LETTER BOX(16:9),
- EDGE CROP

WIDE CONVERT

- ▶SQUEEZE,
- LETTER BOX(16:9),
- EDGE CROP

HDMI TC OUTPUT

- ▶OFF, ON

(AUDIO SET) (p. 91)

 AUDIO FORMAT	▶LINEAR PCM, DOLBY DIGITAL
AUDIO LIMIT	▶OFF, ON
HEADPHONE OUT	▶STEREO, MONO
INT MIC SET	INT MIC SENS ▶NORMAL, HIGH INT MIC WIND ▶OFF, ON
XLR SET	XLR AGC LINK ▶SEPARATE, LINKED INPUT1 TRIM -18dB - +12dB (▶0dB) INPUT1 WIND ▶OFF, ON INPUT2 TRIM -18dB - +12dB (▶0dB) INPUT2 WIND ▶OFF, ON

(DISPLAY SET) (p. 93)

HISTOGRAM	▶OFF, ON, ON[ZEBRA POINT]
ZEBRA	ON/OFF ▶OFF, ON LEVEL 70 - 100, 100+ (▶70)
PEAKING	ON/OFF ▶OFF, ON COLOR ▶WHITE, RED, YELLOW LEVEL HIGH, ▶MIDDLE, LOW

MARKER	ON/OFF ▶OFF, ON
CENTER	▶ON, OFF
ASPECT	▶OFF, 4:3, 13:9, 14:9, 15:9, 1.66:1, 1.85:1, 2.35:1
SAFETY ZONE	▶OFF, 80%, 90%
GUIDEFAME	▶OFF, ON
FOCUS MAG RATIO	x4.0, x8.0, ▶x4.0/x8.0
CAMERA DATA DISPLAY	OFF, ▶ON
AUDIO LEVEL DISPLAY	▶ON, OFF
ZOOM DISPLAY	▶BAR, NUMBER
FOCUS DISPLAY	▶METER, FEET
SHUTTER DISPLAY	▶SECOND, DEGREE
LCD BRIGHT	▶AUTO, NORMAL, BRIGHT
VF BACKLIGHT	▶NORMAL, BRIGHT
DISPLAY OUTPUT	▶LCD PANEL, ALL OUTPUT

(TC/UB SET) (p. 97)

TC PRESET	▶PRESET, RESET
UB PRESET	▶PRESET, RESET
TC FORMAT	▶DF, NDF
TC RUN	▶REC RUN, FREE RUN
TC MAKE	▶PRESET, REGENERATE
UB TIME REC	▶OFF, ON

(NETWORK SET) (p. 98)

SEND TO SMARTPHONE	
CTRL W/ SMARTPHONE	
AIRPLANE MODE	▶OFF, ON
EDIT DEVICE NAME	
SSID/PW RESET	

Menu items (Continued)



(OTHERS)

(p. 99)

CAMERA PROFILE	MEMORY CARD A, MEMORY CARD B
ASSIGN BUTTON	ASSIGN1, ASSIGN2, ASSIGN3, ASSIGN4, ASSIGN5, ASSIGN6
CLOCK SET	
AREA SET	
SUMMERTIME	▶OFF, ON
LANGUAGE	
DATE REC	▶OFF, ON
BEEP	▶OFF, ON
REC LAMP[F]	▶ON, OFF
REC LAMP[R]	▶ON, OFF
REMOTE CONTROL	▶ON, OFF
MEDIA FORMAT	MEMORY CARD A, MEMORY CARD B
REPAIR IMAGE DB FILE	MEMORY CARD A, MEMORY CARD B
USB CONNECT	
OPERATION TIME	
VERSION DISPLAY	
CALIBRATION	



(EDIT)

PROTECT	
DIVIDE	
DELETE	
PHOTO CAPTURE	
COPY	

Tips

- You can display the [EDIT] menu by pressing the MENU button when the VISUAL INDEX or playback screen is displayed.

(CAMERA SET) menu

Settings to adjust your camcorder to the recording conditions (GAIN SET/STEADYSHOT, etc.)

The default settings are marked with ▶.

See page 81 for details on selecting menu items.

Press the MENU button → select (CAMERA SET) with the SEL/PUSH EXEC dial.

GAIN SET

You can set gain values for H, M and L positions of the gain switch.

Default setting:

[H]: 18dB, [M]: 9dB, [L]: 0dB

- ① Select [H], [M] or [L] with the SEL/PUSH EXEC dial.
- ② Set the gain value with the SEL/PUSH EXEC dial, then press the dial.
You can select a value between -6dB and 30dB in 3dB increments. The larger the value, the higher the gain.
- ③ Select [OK] with the SEL/PUSH EXEC dial.

AGC LIMIT

You can select the upper limit for the Auto Gain Control (AGC).

▶OFF, 21dB - 0dB (3dB increments)

Notes

- This function is not effective while you adjust the gain manually.

WB PRESET

You can use the preset white balance. For more details, see page 41.

WB OUTDOOR LEVEL

You can set an offset value to adjust the outdoor white balance when you set [WB PRESET] to [OUTDOOR].

-7 - ►0 - +7
(bluish - normal - reddish)

WB TEMP SET

You can set the color temperature when you set [WB PRESET] to [MANU WB TEMP].

2300K - ►6500K - 15000K (100K increments)

AE SHIFT

■ ON/OFF

► OFF

Does not use the AE SHIFT function.

ON

Uses the AE SHIFT function. The selected value (-2.0EV for example) appears on the LCD screen.

■ LEVEL

You can set an offset value to adjust the automatic exposure adjustment value with the SEL/PUSH EXEC dial.

-2.0EV - ►0EV - +2.0EV
(dark - standard - bright)

🔧 Notes

- This function is not effective while you adjust the iris, shutter speed, gain all manually.

💡 Tips

- You can assign [ON/OFF] to an ASSIGN button (p. 62).

ZOOM SET

■ ZOOM TYPE

► OPTICAL ZOOM ONLY

Uses only optical zoom. You can zoom up to 20x

ON[CLEAR IMAGE ZOOM]

You can use the clear image zoom in addition to the optical zoom.

You can zoom up to 40x, which includes 20x optical zoom.

ON[DIGITAL ZOOM]

You can use the digital zoom in addition to the optical zoom and clear image zoom.

You can zoom up to 320x but the image quality deteriorates within the range where  is displayed.

💡 Tips

- Clear image zoom maintains an image quality that is close to the original.
- The face detection function will not be effective while using the digital zoom.

■ HANDLE ZOOM

You can select the zoom speed for the FIX position of the handle zoom switch.

1 - ►3 - 8

(slow - normal - fast)

■ SPEED ZOOM

You can increase the zoom speed of the power zoom lever and the handle zoom.

► OFF

ON

🔧 Notes

- When you set this function to [ON], the operation sound of the zoom may also be recorded at the movie recording.

STEADYSHOT

You can set the camera shake reduction when shooting.

► STANDARD ()

Uses SteadyShot under relatively stable condition.

ACTIVE ()

Uses SteadyShot with more powerful effect.

Press the MENU button → select  (CAMERA SET) with the SEL/PUSH EXEC dial.

OFF (👤)

Does not use SteadyShot. This setting is recommended when you use a tripod.

🔊 Notes

- When [ACTIVE] is selected, the angle of view shifts 1.08 times toward the telephoto side.

💡 Tips

- You can assign this function to an ASSIGN button (p. 62).

CONVERSION LENS

You can set this when using a conversion lens (sold separately) compatible with this camcorder. SteadyShot and focus are adjusted optimally.

▶ OFF

Select this when not using a conversion lens.

WIDE CONVERSION

Select this when using a wide conversion lens.

S&Q MOTION

See page 60.

AUTO MODE SET

See page 46.

SCENE SELECTION SET

See page 47.

SPOT METER/FOCUS

You can adjust the brightness and focus for the selected subject automatically.

💡 Tips

- Automatic brightness adjustment can be canceled by setting the AUTO/MANUAL switch to AUTO.

SPOT METER

You can adjust the brightness for the selected subject automatically.

💡 Tips

- Automatic brightness adjustment can be canceled by setting the AUTO/MANUAL switch to AUTO.

SPOT FOCUS

See page 33.

AUTO SLOW SHUTTER

You can set the shutter speed to slow down automatically up to 1/30 (up to 1/24 when shooting in 24p) (NTSC model) or up to 1/25 (PAL model) when recording in a dark place.

▶ OFF

Does not use the AUTO SLOW SHUTTER function.

ON

Uses the AUTO SLOW SHUTTER function.

FACE DETECTION

See page 34.

COLOR BAR

■ ON/OFF

▶ OFF

Does not display color bars.

ON

Displays color bars on the LCD screen, records them on recording media, and outputs audio tone signals.

This function helps you to adjust colors when you view movies recorded with your camcorder on a TV or a monitor.

Notes

- This function is automatically set to [OFF] when you switch the format, perform the function by the MENU button, or turn off the camcorder.
- You cannot change the setting during recording or expanded focus operation.
- When [SIMUL/RELAY REC] is set to [MP4 SIMUL REC], [COLOR BAR] cannot be set to [ON].

TONE

▶ OFF

Does not output audio tone signals.

ON

Outputs audio tone signals (1 kHz: full bit -20dB (NTSC model), -18dB (PAL model)). Set [ON/OFF] to [ON], too.

Tips

- You can assign [ON/OFF] to an ASSIGN button (p. 62).
- If you record color bars with [TONE] set to [OFF], the camcorder records sound from the microphone.

⇄ (REC/OUT SET) menu

Recording settings, input and output settings (REC SET/VIDEO OUT, etc.)

The default settings are marked with ▶. See page 81 for details on selecting menu items.

Press the MENU button → select ⇄ (REC/OUT SET) with the SEL/PUSH EXEC dial.

REC SET

■ [HD] REC FORMAT

See page 35.

■ SIMUL/RELAY REC

See page 29.

■ REC BUTTON SET

See page 29.

■ DV MODE

See page 36.

■ [DV] WIDE REC

You can set the aspect ratio when recording in standard definition image quality (DV).

▶ OFF (4:3)

Records in 4:3.

ON

Records in 16:9.

Notes

- When recording in high definition image quality (HD), the aspect ratio is fixed to 16:9.

■ CANCEL DV MODE

See page 37.

VIDEO OUT

■ HDMI

You can select the resolution of the output signal from the HDMI jacks.

NTSC model:

1080p/480i

Press the MENU button → select  (REC/OUT SET) with the SEL/PUSH EXEC dial.

720p/480i

▶ 1080i/480i

480p

480i

PAL model:

1080p/576i

720p/576i

▶ 1080i/576i

576p

576i

Tips

- See page 72 on the output resolution of the signal for each connecting cable.

DOWN CONVERT TYPE

You can select a down convert type when you down-convert video signal. Use this function for outputting movies and still images recorded in 16:9.

▶ **SQUEEZE**

Outputs a horizontally compressed image while maintaining its original height.

LETTER BOX(16:9)

Outputs a vertically compressed image while maintaining its original aspect ratio.

EDGE CROP

Outputs the central portion of the original image by cropping its right and left edges.

WIDE CONVERT

You can select a down convert type when you down-convert video signal. Use this function for outputting DV movies recorded with [ WIDE REC] set to [ON].

▶ **SQUEEZE**

Outputs a horizontally compressed image while maintaining its original height.

LETTER BOX(16:9)

Outputs a vertically compressed image while maintaining its original aspect ratio.

EDGE CROP

Outputs the central portion of the original image by cropping its right and left edges.

Notes

- When you view a movie recorded in standard definition image quality (DV) with [ WIDE REC] set to [ON] on a standard 4:3 TV, images may appear horizontally compressed while maintaining its original height. In such a case, select [LETTER BOX(16:9)] or [EDGE CROP].
- If you change the setting from [SQUEEZE] to another option, or from another option to [SQUEEZE], the screen will go out momentarily, and the image and sound will be intermitted.

HDMI TC OUTPUT

You can set whether to output time code to other professional-use devices, using HDMI.

▶ **OFF**

Does not overlap the time code information on HDMI output signal.

ON

Overlaps the time code information on HDMI output signal*. The data is transmitted as digital data, not as a projected image, and the connected device identifies the time data by referencing the transmitted digital data.

* If the frame rate is 24p, 2-3 pulldown is performed and the converted information is automatically added and transmitted.

♪ (AUDIO SET) menu

Settings for the audio recording
(**HD**: AUDIO FORMAT/XLR SET, etc.)

The default settings are marked with ►.
See page 81 for details on selecting menu items.

Press the MENU button → select
♪ (AUDIO SET) with the SEL/PUSH
EXEC dial.

HD AUDIO FORMAT

You can set the audio format for high definition image quality (HD) recording.

► LINEAR PCM (♪LPCM)

Records in Linear PCM system.

DOLBY DIGITAL (♪DolbyD)

Records in Dolby Digital system.

🔊 Notes

- Audio format is fixed to LPCM with the standard definition image quality (DV) recording.

AUDIO LIMIT

You can set the clipping-noise reduction function for CH1/CH2.

► OFF

Disables the function.

ON

Enables the function.

🔊 Notes

- This function is available only when you set the AUTO/MAN (CH1/CH2) switches to MAN.

HEADPHONE OUT

You can set the sound to output to the headphone when the HEADPHONE MONITOR switch is set to MIX.

► STEREO

Outputs in stereo.

MONO

Outputs in monaural.

🔊 Notes

- When you select [STEREO] and the internal microphone for both CH1 and CH2 (CH1: INT MIC, CH2: INT MIC), during shooting or standby mode, sound output from the headphones will have less stereo effect than the actual recorded sound.

INT MIC SET

■ INT MIC SENS

You can set the recording sensitivity when using the internal microphone.

► NORMAL

Sensitivity generally used for professional-use devices

HIGH

Sensitivity generally used for consumer-use devices

■ INT MIC WIND

Diminish low tone in input sound with the internal microphone, and reduce wind noise.

► OFF

Disables wind noise reduction.

ON (🔊)

Enables wind noise reduction.

XLR SET

■ XLR AGC LINK

You can select either linked or separate AGC (Auto Gain Control) of CH1 and CH2 when using an external microphone (sold separately).

► SEPARATE

Separately applies the AGC for CH1/CH2. Sound inputs from CH1/CH2 will be recorded as separate sound.

LINKED (♪A₁)]

Applies the AGC of CH1 linked with that of CH2. Sound inputs from CH1/CH2 will be recorded as a set of sound such as stereo sound. A [appears on the status check screen.

Press the MENU button → select  (AUDIO SET) with the SEL/PUSH EXEC dial.

Notes

- This function is available when the CH1 and CH2 switches are both set to AUTO and the INPUT 1 and INPUT 2 switches are both set to MIC or both set to LINE (p. 43).

■ INPUT1 TRIM

You can adjust the input signal level from INPUT 1.

-18dB, -12dB, -6dB, ►0dB, +6dB, +12dB

Notes

- The setting is not effective when you set the INPUT 1 switch to LINE.

■ INPUT1 WIND

► OFF

Disables wind noise reduction.

ON

Enables wind noise reduction.

 appears on the status check screen.

Notes

- The setting is not effective when you set the INPUT 1 switch to LINE.

■ INPUT2 TRIM

■ INPUT2 WIND

You can set INPUT 2 in the same way as INPUT 1.

Tips

- -48 dBu is set as 0dB in your camcorder.
- The recommended setting for INPUT TRIM depends on the microphone (sold separately) you use (p. 20).
- The INPUT TRIM function adjusts the input level from an external microphone. When using a highly sensitive microphone or recording loud sound, set this to the minus side. When using a less sensitive microphone or recording quiet sound, set it to the plus side.
- Distortion when recording loud sound may result at the input point, or at the recording point. If it is distorted at the input point, adjust the sound using the INPUT TRIM function. If it is distorted at the recording point, lower the total volume level manually.

- If you set INPUT TRIM too far to the minus side, the microphone volume becomes too low, resulting in a poor signal to noise ratio.
- Test the effect of [XLR SET] according to the microphone used or the sound field of the recording site before actual recording.

■ (DISPLAY SET) menu

Display settings (MARKER/DISPLAY OUTPUT, etc.)

The default settings are marked with ►.
See page 81 for details on selecting menu items.

Press the MENU button → select ■ (DISPLAY SET) with the SEL/PUSH EXEC dial.

HISTOGRAM

The histogram displays the luminance distribution that shows how many pixels of a particular brightness exist in the image.

► OFF

Does not display the histogram.

ON

Displays a histogram. A line appears at the 100% position, and the color of the zone above the line changes.



Histogram

ON[ZEBRA POINT]

The histogram shows the point where the zebra pattern appears. A line is displayed at the brightness level set with [ZEBRA].

💡 Tips

- You can assign this function to an ASSIGN button (p. 62).

ZEBRA

You can display a zebra pattern as a guide for adjusting brightness.

■ ON/OFF

► OFF

Does not display the zebra pattern.

ON (■ and the brightness level)

The zebra pattern is not recorded with the image.

■ LEVEL

You can select the brightness level.

►70 to 100 or 100+

💡 Tips

- The zebra pattern is a stripe pattern that appears in areas of brightness equal to or exceeding the brightness level you have set.
- You can assign [ON/OFF] to an ASSIGN button (p. 62).

PEAKING

■ ON/OFF

► OFF

Does not display the peaking.

ON (PEAKING)

You can display an image on the LCD screen with its outlines enhanced. This function helps you to adjust the focus.

■ COLOR

You can select peaking color.

►WHITE, RED, YELLOW

■ LEVEL

You can select a peaking sensitivity.

HIGH, ►MIDDLE, LOW

🔍 Notes

- The enhanced outlines will not be recorded on the recording media.

Press the MENU button → select  (DISPLAY SET) with the SEL/PUSH EXEC dial.

Tips

- You can focus more easily using this function in combination with the expanded focus function (p. 33).
- You can assign [ON/OFF] to an ASSIGN button (p. 62).

MARKER

■ ON/OFF

▶ OFF

Does not display markers.

ON

Displays markers. Markers are not recorded on the recording media.

■ CENTER

▶ ON

Displays a marker at the center of the LCD screen.

OFF

Does not display a center maker.



■ ASPECT

▶ OFF

Does not display the aspect ratio.

4:3, 13:9, 14:9, 15:9, 1.66:1, 1.85:1, 2.35:1

Displays markers at boundaries of display area defined by the aspect ratio.



■ SAFETY ZONE

▶ OFF

Does not display the safety zone.

80%, 90%

If you select either one, you can display markers at boundaries of display area that regular home TVs can display.



■ GUIDEFRAME

▶ OFF

Does not display the guide frame.

ON

Displays the guide frame.

You can check the horizontal and vertical aspect of a subject.



Notes

- Only the time code is output to an external device via external output jacks when [MARKER] is set to [ON], even if [DISPLAY OUTPUT] is set to [ALL OUTPUT].
- You cannot display markers during [FOCUS MAGNIFIER].
- You can display markers only on the LCD screen. You cannot display them on an external device.

Tips

- You can display all types of markers at the same time.
- You can obtain a balanced composition by positioning the subject at the cross points of the guideframe marker.
- You can assign [ON/OFF] to an ASSIGN button (p. 62).

FOCUS MAG RATIO

You can set the magnification of expanded focus.

×4.0

×8.0

▶ ×4.0/×8.0

The setting changes in the order [×4.0] → [×8.0] → [OFF] with each press of the FOCUS MAGNIFIER button.

CAMERA DATA DISPLAY

OFF

Does not display the iris, gain and shutter speed settings.

► ON

Constantly displays the iris, gain and shutter speed settings on the LCD screen.

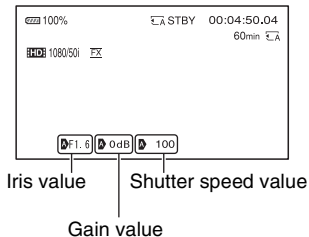

💡 Tips

- The settings appear on the LCD screen during the manual adjustment regardless of the settings of this function.
- **A** indicates that the settings are automatically adjusted values.
- **E** appears when exposure is fixed by [SPOT METER] or [SPOT METER/FOCUS].
- The displayed settings are different from the settings that will be displayed when you press the DATA CODE button (p. 69).
- You can assign this function to an ASSIGN button (p. 62).

AUDIO LEVEL DISPLAY

► ON

Displays the audio level meters on the LCD screen.

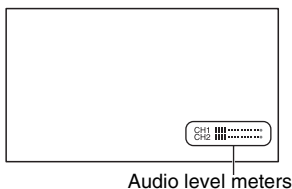

OFF

Does not display the audio level meters.

💡 Tips

- You can assign this function to an ASSIGN button (p. 62).

ZOOM DISPLAY

► BAR

Displays a bar that indicates the zoom position.

NUMBER

Displays a number that indicates the zoom position.

FOCUS DISPLAY

► METER

Displays the focal length in meters.

FEET

Displays the focal length in feet.

SHUTTER DISPLAY

► SECOND

Displays the shutter display in seconds.

DEGREE

Displays the shutter display in degrees.

The shutter speed equal to the period that your camcorder reads image data from the image sensor is defined as 360 degrees. The degree is calculated based on this definition and displayed.

- NTSC model
 - With a frame rate of 60 selected in [HDD] REC FORMAT], when the shutter speed is 1/60, the shutter angle is 360 degrees.
 - With a frame rate of 30 selected in [HDD] REC FORMAT], when the shutter speed is 1/30, the shutter angle is 360 degrees.

Press the MENU button → select  (DISPLAY SET) with the SEL/PUSH EXEC dial.

– With a frame rate of 24 selected in [ REC FORMAT], when the shutter speed is 1/24, the shutter angle is 360 degrees.

• PAL model

– With a frame rate of 50 selected in [ REC FORMAT], when the shutter speed is 1/50, the shutter angle is 360 degrees.

– With a frame rate of 25 selected in [ REC FORMAT], when the shutter speed is 1/25, the shutter angle is 360 degrees.

See page 35 for details on [ REC FORMAT] setting.

Notes

- When pressing the DATA CODE button, shutter speed is displayed in seconds regardless of this setting.

Tips

- If the shutter speed is more than 360 degrees, it is displayed as an integral multiple of 360 degrees (360° × 2, etc.).

LCD BRIGHT

You can adjust the brightness of the LCD screen. Changes in the LCD brightness are not affect the brightness of recording images.

▶ AUTO

NORMAL

BRIGHT

Notes

- When [AUTO] is selected, the LCD screen illuminates brightly if the AC Adaptor is connected to the camcorder or the LCD screen is rotated.
- Do not cover the illuminance sensor with hand.

VF BACKLIGHT

You can adjust the brightness of the viewfinder.

▶ NORMAL

BRIGHT

DISPLAY OUTPUT

You can select where to output the display information, such as time code.

▶ LCD PANEL

Outputs the information to the LCD screen.

ALL OUTPUT

Outputs information to the HDMI OUT and VIDEO OUT jacks, and the LCD screen. Zebra, peaking and the frame on the face are also output.

Notes

- Only the time code, zebra, peaking and the frame on the face are output when [MARKER] is set to [ON] and a marker is displayed on the LCD screen.

00:00 (TC/UB SET) menu

Time code settings (TC PRESET/UB PRESET/TC FORMAT, etc.)

The default settings are marked with ►. See page 81 for details on selecting menu items.

Press the MENU button → select 00:00 (TC/UB SET) with the SEL/PUSH EXEC dial.

TC PRESET

See page 59.

UB PRESET

See page 59.

TC FORMAT (NTSC model only)

You can select the time code recording method (NTSC model only). For the PAL model, this setting is fixed to [NDF].

► DF

Records the time code in drop frame.

NDF

Records the time code in non-drop frame.

ⓘ Notes

- This setting is fixed to [NDF] when recording in 1080/24p on the NTSC model.

💡 Tips

Drop frame

Time code is based on 30 frames per second; however, gaps in the actual time occur during extended periods of recording as the actual frame frequency of NTSC image signal is 29.97 frames per second. Drop frame corrects this gap to make time code and actual time equal. In drop frame, the first 2 frame numbers are removed every minute except in every tenth minute. Time code without this correction is called non-drop frame.

TC RUN

You can select how the time code advances.

► REC RUN

Advances the time code only during recording.

Select this setting to record the time code sequentially from the last time code of the previous recording.

FREE RUN

Advances the time code regardless of operation of your camcorder.

ⓘ Notes

- Even if the time code advances in the [REC RUN] mode, the time code may not be recorded sequentially in the following cases:
 - When the recording format is changed.
 - When the recording media is removed.

TC MAKE

► PRESET

Records the newly set time code on the recording media.

REGENERATE

Reads the last time code of the previous recording from the recording media and records the new time code consecutively from the last time code during the backspace editing.

The time code runs in [REC RUN] mode regardless of the setting of [TC RUN].

UB TIME REC

► OFF

Does not save the actual time in the user bit code.

ON

Saves the actual time in the user bit code.

ⓘ Notes

- The last 2 digits are fixed to 00 when it is set to [ON].

(NETWORK SET) menu

Settings for the Wi-Fi function (SEND TO SMARTPHONE/CTRL W/SMARTPHONE, etc.)

The default settings are marked with ►.

See page 81 for details on selecting menu items.

Press the MENU button → select  (NETWORK SET) with the SEL/PUSH EXEC dial.

SEND TO SMARTPHONE

See page 50.

CTRL W/SMARTPHONE

See page 49.

AIRPLANE MODE

Wi-Fi-related settings can be disabled (when boarding a plane, etc.).

► OFF

Airplane mode is turned off.

ON (↑)

Airplane mode is turned on.

↑ will be displayed on the screen.

EDIT DEVICE NAME

You can change the name of a Wi-Fi Direct device, etc.

How to use the keyboard

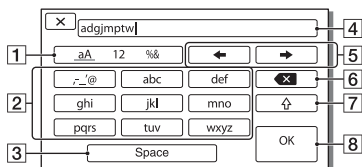

Screen items	Functions
1 Switch character type	Characters switch between alphabetical letters, numerals and symbols.
2 Keyboard	Characters are displayed in the order they are touched.
3 Space	Enters a space.
4 Input box	Entered characters are displayed.
5 Move cursor	Moves the cursor in the input box to the left or right
6 Delete	Deletes the character preceding the cursor
7 ↑	Switches between uppercase and lowercase alphabetical letters
8 OK	Confirms an input operation

To cancel character input midway, press X.

SSID/PW RESET

The connection information that you registered in order to use [CTRL W/SMARTPHONE] and [SEND TO SMARTPHONE] can be reset.

Notes

- If the connection information has been reset, it will be necessary to set up the smartphone again, in order to connect it to the camcorder.

(OTHERS) menu

Settings while recording or other basic settings (AREA SET/BEEP, etc.)

The default settings are marked with ►.
See page 81 for details on selecting menu items.

Press the MENU button → select  (OTHERS) with the SEL/PUSH EXEC dial.

CAMERA PROFILE

You can save up to 99 camera profile settings in a memory card for easy recall at any time.

In addition, if you should require multiple camcorders with the same settings, you can load the desired settings to all cameras via the memory card.

Notes

- The file may not be shown properly if the file name is changed on the computer, or the power turned off during generation.
- Formatting the memory card also deletes saved camera profiles.

Tips

- Items that can be saved include setting values for menus, picture profiles, buttons, etc. You can save these setting values all together in the camera profile.

■ LOAD

Load the camera profile, and execute the settings.

- ① Select the camera profile to be loaded with the SEL/PUSH EXEC dial.
- ② Select [YES] on the confirmation screen.
The camcorder restarts, and the loaded camera profile becomes effective.

Notes

- A camera profile saved on a camcorder with different model name, or edited on a computer cannot be loaded.

■ SAVE

You can save the camera profile.

- ① Select [NEW FILE] or an existing profile name with the SEL/PUSH EXEC dial.
- ② Select [YES] on the confirmation screen.
The camera profile is saved.

Tips

- When you select [NEW FILE], the profile is named [01] (when saving for the first time).
- If you select an existing camera profile, the current setting values are overwritten.
- You cannot use a computer to edit saved settings.

■ DELETE

You can delete the saved camera profile.

- ① Select the camera profile to be deleted with the SEL/PUSH EXEC dial.
- ② Select [YES] on the confirmation screen.

ASSIGN BUTTON

See page 62.

CLOCK SET

See page 23.

AREA SET

You can adjust a time difference without stopping the clock. When you use your camcorder abroad, you can adjust the clock to the local time.

SUMMERTIME

You can change this setting without stopping the clock. Set to [ON] to move the time forward 1 hour.

► OFF

Does not set the summertime.

Press the MENU button → select  (OTHERS) with the SEL/PUSH EXEC dial.

ON

Sets the summertime.

LANGUAGE

You can select the language to be used on the LCD screen.

DATE REC

▶ OFF

Does not superimpose the date and time on images.

ON

Superimposes the date and time on images.

Tips

- You can set this item only when the interlace scanning system is selected.
- When zebra or peaking is activated, the date and time characters are affected by the signal, but properly recorded on images.

Notes

- [DATE REC] cannot be set to [ON] when [SIMUL/RELAY REC] is set to [MP4 SIMUL REC].

BEEP

▶ OFF

Cancels the melody.

ON

Activates a melody when you start/stop recording, or when you are warned with warning indicators, etc.

REC LAMP[F] (Recording lamp [front])

▶ ON

Turns on the front camera recording lamp.

OFF

Turns off the front camera recording lamp.

Tips

- You can assign this function to an ASSIGN button (p. 62).

REC LAMP[R] (Recording lamp [rear])

▶ ON

Turns on the rear camera recording lamp.

OFF

Turns off the rear camera recording lamp.

Tips

- You can assign this function to an ASSIGN button (p. 62).

REMOTE CONTROL

▶ ON

Enables the supplied Wireless Remote Commander (p. 10).

OFF

Disables the supplied Wireless Remote Commander to prevent misoperation by the remote control of another device.

MEDIA FORMAT

See page 78.

REPAIR IMAGE DB FILE

See page 80.

USB CONNECT

Select this item when [USB CONNECT] does not appear on the LCD screen by connecting the camcorder to another device with the USB cable.

OPERATION TIME

Displays the total hours of operation in 10-hour increments.

VERSION DISPLAY

Displays the current version of your camcorder. Be sure to check for firmware updates.

Notes

- To perform an update, use the AC Adaptor.

CALIBRATION

See page 123.

Saving images on an external media device

You can save images on an external media device (USB storage devices), such as an external hard disk drive. You can also play back images on the camcorder or another playback device.

🔊 Notes

- Refer also to the instruction manuals supplied with the external media device.

💡 Tips

- You can import images saved on the external media device to your computer by using the software “Content Browser.”

Functions available after saving images on an external media device

- playback of images through the camcorder (p. 103)
- importing images to a computer

Devices that cannot be used as an external media device

You cannot use the following devices as an external media device.

- ordinary disc drive such as CD or DVD drive
- media devices connected via a USB hub
- media devices with built-in USB hub
- card reader

🔊 Notes

- You may not be able to use external media devices with a code function.
- Your camcorder works with both FAT and NTFS file systems. External media formatted on another device needs to be formatted by a computer, etc., before use. The format screen appears when an external media device is connected to your camcorder. Make sure that important data has not previously been saved on the external media device before you format it.
- Operation is not assured with every device satisfying requirements for operating.
- For details on available external media devices, go to the Sony support website in your country/region.

1 Connect your camcorder to the wall outlet (wall socket) using the AC Adaptor AC-L100C (supplied) (p. 20).

2 If the external media device has the AC power cable, connect it to the wall outlet (wall socket).

3 Connect the USB Adaptor Cable (sold separately) to the external media device.

4 Turn on your camcorder, and connect the USB Adaptor Cable (sold separately) to the USB jack of your camcorder.

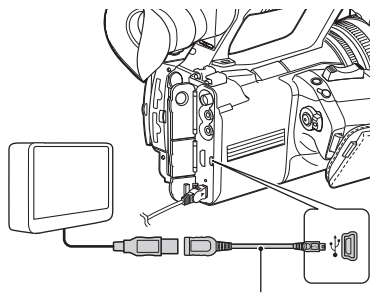

USB Adaptor Cable (sold separately)

5 Touch [Copy.] on the LCD screen.

6 Select [MEMORY CARD A] or [MEMORY CARD B] that contains the images you want to save.

Images that have not yet been saved on an external media device are saved on the connected media device at this time.

- This operation is available only when there are newly recorded images.

7 After the operation is completed, touch **OK** on the LCD screen.

You can make menu settings of the external media device such as deleting images. Press the MENU button and select the  (EDIT) menu.

Notes

- The number of scenes you can save on the external media device are as follows. Even if the external media device has free space, you cannot save scenes exceeding the following number. The number of scenes may be smaller depending on the camcorder setting and the type of images recorded.
 - High definition image quality (HD) movies: Max. 3,999
 - Still images: Max. 40,000

Playing back images in the external media device on the camcorder

When the camcorder is connected to the external media device, the images saved in the external media device are displayed on the LCD screen of the camcorder. The recording media icon on the VISUAL INDEX screen changes as follows.

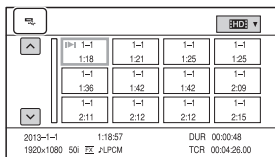

Creating a standard definition image quality (DV) disc with a recorder, etc.

You can copy images on your camcorder onto a disc or video cassette, by connecting your camcorder to a disc recorder with the A/V connecting cable (sold separately). Refer also to the instruction manuals supplied with the devices to be connected.

⚙ Notes

- High definition image quality (HD) movies will be copied with standard definition image quality (DV).

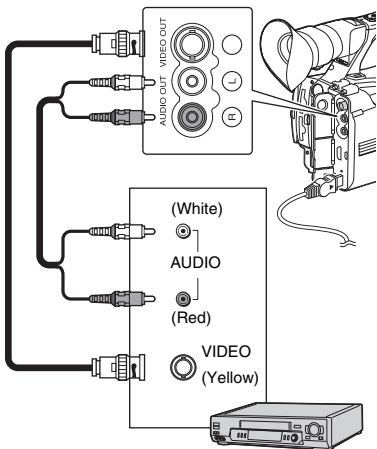

1 Connect your camcorder to the wall outlet (wall socket) using the AC Adaptor AC-L100C (supplied) (p. 20).

2 Insert the recording media in the recording device.

If your recording device has an input selector, set it to the input mode.

3 Connect your camcorder to the recording device (a disc recorder, etc.) with the A/V connecting cable (sold separately).

Connect your camcorder to the input jacks of the recording device.

4 Start playback on your camcorder, and record it on the recording device.

For details, refer to the instruction manuals supplied with the device to be connected.

5 When copy is finished, stop the recording device, and then your camcorder.

⚙ Notes

- Since copying is performed via analog data transfer, the image quality may deteriorate.
- You cannot copy images to recorders connected with an HDMI cable.
- When you do not want to display the counter, etc. on the screen of the recording device, press the MENU button, and select (DISPLAY SET) → [DISPLAY OUTPUT] → [LCD PANEL].
- To copy date/time information and camera data, press the DATA CODE button and make a desired setting. In addition, press the MENU button, select (DISPLAY SET) → [DISPLAY OUTPUT] → [ALL OUTPUT].
- When the screen size of display devices (TV, etc.) is 4:3, set [DOWN CONVERT TYPE] (p. 90).
- When you connect a monaural device, connect the yellow plug of the A/V connecting cable (sold separately) to the video input jack, and the white (left channel) or the red (right channel) plug to the audio input jack on the device.
- If the recorder has PIN jacks, a BNC to PIN adapter is required.

Troubleshooting

If you run into any problems using your camcorder, follow the flow chart below.

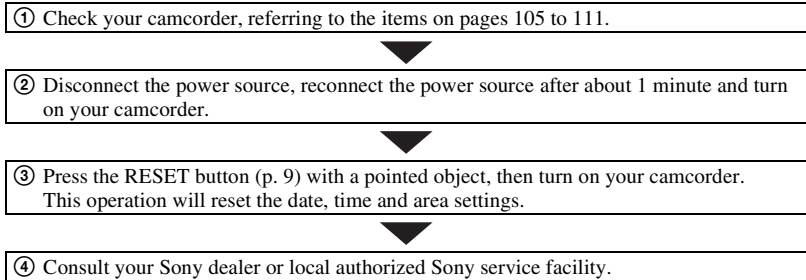

- Power sources/LCD screen/Wireless Remote Commander...p. 105
- Memory card...p. 106
- Recording...p. 107
- Playback...p. 109
- Connecting to TV...p. 110
- Copying/Editing/Connecting to other devices...p. 110
- Connecting to a computer...p. 111

Power sources/LCD screen/Wireless Remote Commander

The power does not turn on or abruptly turns off.

- Attach a charged battery pack to the camcorder (p. 18).
- Use the AC Adaptor to connect the camcorder to a wall outlet (wall socket) (p. 18).

The camcorder does not operate even when the power is set to on.

- Disconnect the power source (battery or AC Adaptor), then reconnect it after about 1 minute.
- Press the RESET button (p. 9) using a pointed object.

The camcorder gets warm.

- The camcorder may get warmer while you use it. This is not a malfunction.

The remaining battery indicator does not indicate the correct figure.

- Ambient temperature is too high or too low, or the battery pack has not been charged enough. This is not a malfunction.
- Fully charge the battery again. If the problem persists, the battery may be worn-out. Replace it with a new one (p. 18, 120).
- The indicated figure may not be correct in certain circumstances. For example, when you open or close the LCD screen, it takes about 1 minute to display the correct remaining battery.

The battery pack discharges too quickly.

- Ambient temperature is too high or low, or the battery pack has not been charged enough. This is not a malfunction.
 - Fully charge the battery again. If the problem persists, the battery may be worn-out. Replace it with a new one (p. 18, 120).
-

The image on the viewfinder is not clear.

- Move the viewfinder lens adjustment lever until the image appears clearly (p. 24).
-

The supplied Wireless Remote Commander does not function.

- Set [REMOTE CONTROL] to [ON] (p. 100).
 - Remove any obstructions between the Wireless Remote Commander and the remote sensor of the camcorder.
 - Keep strong light sources, such as sunlight or overhead lighting, away from the remote sensor, otherwise the Wireless Remote Commander may not function properly.
 - Insert a fresh battery in the compartment with its +/- terminals matching those of the compartment (p. 10).
-

Another video device malfunctions when you use the supplied Wireless Remote Commander.

- Select a commander mode other than DVD2 for your video device.
 - Cover the sensor of your video device with black paper.
-

When a device is connected to the REMOTE jack, the camcorder or the device does not operate properly.

- The connected device may react slowly to some operations.
 - If you disconnect the cable from the device while the cable is still connected to the camcorder's REMOTE jack, the camcorder may not restore the proper settings. Disconnect the cable also from the camcorder's REMOTE jack.
-

Memory card

The camcorder does not operate with the memory card inserted.

- The memory card was formatted on a computer. Format it on this camcorder (p. 78).
-

The data file name is incorrect, or flashing.

- The file is damaged.
 - Use a file format supported by your camcorder (p. 118).
-

The recording media indicator is flashing.

- Something wrong happened to recording media. Stop recording of all recording media, and repair the database file.

Images on the recording media cannot be deleted.

- You can select no more than 100 images to be deleted on the edit screen.
- The images are protected. Unprotect the images (p. 74).

Recording**The recording does not start when you press the record button.**

- The playback screen is displayed. Finish playback operation (p. 66).
- There is no empty space on the recording media. Replace the recording media with a new one, delete unnecessary images (p. 75) or format the recording media (p. 78).
- Total number of movie scenes exceeds the recordable capacity of your camcorder (p. 116). Delete unnecessary images (p. 75).
- The temperature of your camcorder is extremely high. Turn off your camcorder and leave it for a while in a cool place.
- The temperature of your camcorder is extremely low. Turn off your camcorder and leave it for a while in a warm place.
- Something wrong happened to one of recording media. Stop recording of all recording media, and repair the database file.

The handle zoom does not work.

- Set the handle zoom switch to VAR or FIX (p. 31).

The access lamp remains lit even after recording was stopped.

- Your camcorder is recording the scene you have just shot on the memory card.

The imaging field looks different.

- The imaging field may look different depending on the condition of your camcorder. This is not a malfunction.

The actual recording time for movies is less than the estimated recording time of the recording media.

- Depending on the recording conditions, the time available for recording may be shorter, for example when recording a fast moving object, etc. (p. 115).

The camcorder does not keep the setting changes.

- Some menu items return to the default setting when the power is turned off.
- The [FOCUS MAGNIFIER] setting is not stored.
- The power sources have been disconnected when the POWER switch was set to ON. Before disconnecting the battery or the AC Adaptor, set the POWER switch to OFF and make sure that the access lamp is turned off.

There is a time difference between the point when the record button is pressed and the point that the recording movie is started or stopped actually.

- On your camcorder, there may be a slight time difference between the point where you press the record button and the actual point that recording movie starts/stops. This is not a malfunction.
-

The aspect ratio (16:9 (wide)/4:3) cannot be changed.

- The aspect ratio of high definition image quality (HD) movies is 16:9 (wide).
-

Automatic focus does not function.

- Set the FOCUS switch to AUTO to enable the automatic focus function (p. 32).
 - Adjust the focus manually if the automatic focus does not work properly (p. 32).
-

Menu items are grayed out or do not work.

- You cannot select grayed out display items in the current recording/playback situation.
- There are some functions you cannot activate simultaneously. The following list shows examples of unworkable combinations of functions and menu items.

Cannot use	Situation
[ON/OFF] of [AE SHIFT]	All of iris, gain and shutter speed are set manually.
[ZEBRA], [PEAKING]	[COLOR BAR] is set to [ON].
[ON/OFF] of [MARKER]	[FOCUS MAGNIFIER] is set to [ON].
[TC PRESET]	[TC MAKE] is set to [REGENERATE].
[COLOR BAR]	Movies are being recorded. [FOCUS MAGNIFIER] is set to [ON].

Iris, gain, shutter speed, or white balance cannot be adjusted manually.

- Set the AUTO/MANUAL switch to MANUAL.
-

Tiny spots in white, red, blue, or green appear on the LCD screen.

- This phenomenon appears when using a slow shutter speed (p. 39). This is not a malfunction.
-

The subjects passing by the frame very fast appear crooked.

- This is called the focal plane phenomenon. This is not a malfunction. Because of the way that the image device (CMOS sensor) reads out image signals, the subjects passing by the frame rapidly might appear crooked depending on the recording conditions.
-

Horizontal stripes appear on the image.

- This occurs when recording pictures under a fluorescent lamp, sodium lamp, or mercury lamp. This is not a malfunction. This can be improved by changing the shutter speed (p. 39).
-

Black bands appear when you record a TV screen or computer screen.

- This can be improved by adjusting the shutter speed (p. 39).

Fine patterns flicker, diagonal lines look jagged.

- Adjust [DETAIL] to the negative side (p. 58).

The time code is not recorded in sequence.

- The time code may not be recorded sequentially if you change the settings of [HID] REC FORMAT].

Playback

Refer also to the “Memory card” section (p. 106).

The desired images cannot be found. Images cannot be played back.

- Select the recording media and image quality of the image you want to play back on the VISUAL INDEX screen (p. 64).
- Image data cannot be played back if you have modified file names or folders, or have edited the data on a computer (When viewing still images, the file name flashes). This is not a malfunction (p. 120).
- Images recorded on other devices may not be played back, or displayed in incorrect size. This is not a malfunction.
- Display the VISUAL INDEX screen, touch twice on the thumbnail of the image you want to play back, or select the thumbnail with ◀/▶/⏪/⏩ buttons and press the EXEC button (p. 65).

The data file name is displayed incorrectly, or flashing.

- The file is damaged.
- The file format is not supported on your camcorder (p. 118).
- Only the file name is displayed, if the folder structure does not conform to the universal standard.

No sound or only a low sound is heard.

- Turn up the volume (p. 66).

“---” is displayed on the LCD screen.

- Bars will be displayed for the camera data of the movies recorded with [COLOR BAR] set to [ON].
- Bars will be displayed for the exposure compensation value and flash information of the still images created with [PHOTO CAPTURE].

Multi ch appears on the LCD screen.

- This appears when you play back movies recorded with 5.1ch surround sound. 5.1ch surround sound is down-mixed to 2ch stereo and played back on your camcorder.

Connecting to TV

Neither image nor sound is played back on the TV connected with the HDMI cable.

- Images are not output from the HDMI OUT jack, if copyright protection signals are recorded in the images.
- Signals are not output from the HDMI OUT jack when the USB jack is connected.

Neither image nor sound is played back on the TV, projector, or AV amplifier connected with the HDMI cable.

- If you cannot view images or hear sound on the TV, projector, or AV amplifier connected with the HDMI cable, try disconnecting and connecting the HDMI cable, or turn on your camcorder again.

The image appears distorted on the 4:3 TV.

- This happens when viewing a movie recorded in the 16:9 (wide) mode on a 4:3 TV. Select  (REC/OUT SET) → [VIDEO OUT] → [DOWN CONVERT TYPE] → the appropriate down conversion type (p. 90).

Black zone appears at top and bottom of a 4:3 TV screen.

- This happens when viewing a movie recorded in the 16:9 (wide) mode on a 4:3 TV. This is not a malfunction.

Copying/Editing/Connecting to other devices

Time code and other information appear on the display of the connected device.

- Set [DISPLAY OUTPUT] to [LCD PANEL] when you connect a device with the A/V connecting cable (sold separately) (p. 96).

Copy cannot be done correctly using the A/V connecting cable (sold separately).

- The A/V connecting cable (sold separately) is not connected properly. Make sure that the A/V connecting cable (sold separately) is connected to the input jack of the device.

Sound cannot be added to the recording media after recording.

- You cannot add sound to the recording media after recording on your camcorder.

Copy cannot be done correctly using the HDMI cable.

- You cannot copy movies using the HDMI cable.

Connecting to a computer**The computer does not recognize the camcorder.**

- Disconnect the cable from the computer, then connect it again securely.
- Disconnect the cable from your computer and camcorder. Reboot your computer, and connect your computer and camcorder following the steps in the correct order.

Movies cannot be viewed or copied to the computer.

- Disconnect the cable from the computer, then connect it again.
- You need to install the “Content Browser” to copy movies from your camcorder to your computer.

Warning indicators and messages

Self-diagnosis display/Warning indicators

When an error occurs, a warning indicator appears on the LCD screen or in the viewfinder.

You can fix some problems associated with the symptoms yourself. If the problem persists even after you have tried a couple of times, contact your Sony dealer or local authorized Sony service facility.

C:04:□□

- The battery pack is not an “InfoLITHIUM” battery pack. Use an “InfoLITHIUM” battery pack (p. 120).

C:06:□□

- The battery pack is too hot. Replace the battery pack, or remove the battery pack and put it in a cool place.

C:13:□□

- Remove the recording media. After installing them again, operate your camcorder.

C:32:□□

- Remove the power source. Reconnect it and operate your camcorder again.

E:□□:□□

- Try the steps ② to ④ on page 105.

(Battery level warning)

- The battery pack is nearly used up.
- Depending on the operation, environment, or battery conditions,  may flash, even if around 10% is displayed as the battery remaining figure.

(Warning indicator pertaining to battery pack temperature)

- The battery pack is too hot. Replace the battery pack, or remove the battery pack and put it in a cool place.

(Warning indicator pertaining to memory cards)

Slow flashing

- Free spaces for recording images are running out. For the type of memory cards you can use with your camcorder, see page 25.
- No memory card is inserted (p. 25).

Fast flashing

- There are not enough free spaces for recording images. Delete unnecessary images (p. 75), or format the memory card (p. 78) after storing the images on other media (p. 102).
- The image database file may be damaged (p. 80).

(Warning indicator pertaining to memory card formatting)*

- The memory card is damaged.
- The memory card is not formatted correctly (p. 78).

(Warning indicator pertaining to incompatible memory cards)*

- Incompatible memory card is inserted (p. 25).

(Warning indicator pertaining to the write-protect of the memory card)*

- The write-protect switch is set to lock position on the memory card.
- Access to the memory card was restricted on another device.

 (Warning indicator pertaining to the external media device)

- The image database file may be damaged (p. 80).
- The external media device is damaged.

 (Warning indicator pertaining to formatting of the external media device)

- The external media device is damaged.
- Disconnect the external media device once, and format it on a computer. Note that if you format the external media device, all the recorded movies and still images are deleted.
- If the same warning message is displayed after formatting the external media device, the device may be incompatible with your camcorder, or damaged. Replace it with a new one.

* When [BEEP] is set to [ON] (p. 100), you hear a melody when the warning indicators appear on the LCD screen.

Description of warning messages

If messages appear on the LCD screen or in the viewfinder, follow the instructions.

Recording media**Inconsistencies found in image database file. Do you want to repair the image database file?****Inconsistencies found in image database file. Cannot record or play HD movies. Do you want to repair the image database file?**

- You cannot record or play back movies because no movie management information exists. If you touch [OK], new management information is created and you can record or play back movies.

Inconsistencies found in the image database file. Back up and recover. Recover, then import using the included PC software.

- Inconsistencies occur in the image database file because high definition image quality (HD) movie management information is damaged. If you touch [OK], new management information is created by backing up a high definition image quality (HD) movie. The backed up movies cannot be recognized. If you connect to a computer that has been installed with the software "Content Browser," you can copy the backed up high definition image quality (HD) movies.

Buffer overflow. Writing to the media was not completed in time.

- You have performed recording and erasing operations repeatedly, or a memory card that has been formatted by other device is used. Copy and take data backup to other device (such as a computer), and then format the memory card on the camcorder (p. 78).
- The size of the inserted memory card is not sufficient for copying the movie(s). Use the recommended memory card (p. 25).

Recovering data.

- Your camcorder tries to recover data automatically if the data writing was not performed properly.

Cannot recover data.

- Writing data onto the media of the camcorder has failed. Attempts were made to recover the data, but they were unsuccessful.

Reinsert the memory card.

- Reinsert the memory card a few times. If even then the indicator flashes, the memory card could be damaged. Try with another memory card.

Cannot recognize this memory card. Format and use again.

- Format the memory card (p. 78). Note that if you format the memory card, all the recorded movies and photos are deleted.

Still picture folder is full. Cannot record still pictures.

- You cannot create folders exceeding 999MSDCF. You cannot create or delete created folders using your camcorder.
- Format the memory card (p. 78), or delete folders using your computer.

This memory card may not be able to record or play movies.

- Use a memory card recommended for your camcorder (p. 25).

This memory card may not be able to record or play images correctly.

- Use a memory card recommended for your camcorder (p. 25).
- Contact your Sony dealer.

Do not eject the memory card during writing. Data may be damaged.

- Reinsert the memory card, and follow the instructions on the LCD screen.

External media cannot execute functions.

- Check the data base file by pressing the MENU button, then selecting  (OTHERS) → [REPAIR IMAGE DB FILE] → the desired recording media.
- If the warning message persists, disconnect the device once, then format it on a computer, etc. Note that if you format the external media device, all the recorded movies and photos in it are deleted.
- If the same warning message is displayed after formatting the external media device, the device may be incompatible with your camcorder, or damaged. Replace it with a new one.

Unable to access external media.

- Use the external media in a stable condition (vibration-free, at room temperature, etc.)
- Confirm that the external media is not switched off.

Other

Maximum number of images already selected.

- You can select only 100 images at one time for:
 - Deleting movies/photos
 - Protecting movies/photos, or releasing the protection
 - Copying movies/photos

Protected file. Cannot delete.

- You tried to delete protected data. Release the protection of the data.
-

Recording time of movies and the number of recordable photos

Estimated time of recording and playback with each battery pack

Approximate time available when you use a fully charged battery pack.

Recording time

(unit: minute)

Battery pack	Continuous recording time	Typical recording time
NP-F770	275	160
	175	100
NP-F970	410	230
	265	150

Notes

- Recording format
NTSC model: 1080/60i FX
PAL model: 1080/50i FX
- Using an XLR microphone with [LCD BRIGHT] set to [NORMAL]
- Using a memory card
- Top: When the video light is turned off
Bottom: When the video light is turned on
- Typical recording time shows the time when you repeat recording start/stop, turning on/off, and so on.
- Times measured when using the camcorder at 25 °C (77 °F).
- Both recording and playback time will be shorter when you use your camcorder in low temperatures. It is recommended that you use the camcorder from 10 °C to 30 °C (50 °F to 86 °F).
- The recording and playback time will be shorter depending on the conditions under which you use your camcorder.
- The recording time will be shorter if a memory card containing MP4 movies (not deleted by [MEDIA FORMAT] after simultaneous recording) is used.

Playing time

(unit: minute)

Battery pack	
NP-F770	510
NP-F970	760

Estimated recording time of movies

High definition image quality (HD)

When [SIMUL/RELAY REC] is set to [MP4 SIMUL REC]

■ When [AUDIO FORMAT] is set to [LINEAR PCM]

(unit: minute)

	FX	FH	HQ	LP
16 GB	70 (70)	95 (95)	140 (115)	200 (180)
32 GB	150 (150)	190 (190)	290 (235)	405 (365)
64 GB	300 (300)	385 (385)	580 (480)	810 (730)

■ When [AUDIO FORMAT] is set to [DOLBY DIGITAL]

(unit: minute)

	FX	FH	HQ	LP
16 GB	75 (75)	100 (100)	160 (130)	380 (205)
32 GB	155 (155)	205 (205)	325 (260)	770 (420)
64 GB	315 (315)	415 (415)	655 (530)	1545 (845)

Recording time of movies and the number of recordable photos (Continued)

When [SIMUL/RELAY REC] is set to other than [MP4 SIMUL REC]

■ When [AUDIO FORMAT] is set to [LINEAR PCM]

(unit: minute)

	PS	FX	FH	HQ	LP
16 GB	70 (70)	80 (80)	110 (110)	185 (145)	295 (250)
32 GB	145 (145)	170 (170)	225 (225)	375 (290)	590 (510)
64 GB	290 (290)	340 (340)	450 (450)	750 (590)	1190 (1025)

■ When [AUDIO FORMAT] is set to [DOLBY DIGITAL]

(unit: minute)

	PS	FX	FH	HQ	LP
16 GB	75 (75)	90 (90)	120 (120)	215 (165)	380 (310)
32 GB	150 (150)	180 (180)	245 (245)	440 (330)	770 (630)
64 GB	305 (305)	360 (360)	495 (495)	880 (665)	1545 (1260)

Standard definition image quality (DV)

(unit: minute)

	HQ
16 GB	70 (70)
32 GB	140 (140)
64 GB	280 (280)

- When using Sony memory card.

Notes

- The recordable time may vary depending on the recording conditions, subjects, and [REC SET] (p. 89).
- The number in () is the minimum recordable time.

Tips

- You can record movies of a maximum of 3,999 scenes with high definition image quality (HD), and 9,999 scenes with standard definition image quality (DV).
- The maximum continuous recording time for a movie is approximately 13 hours.
- Your camcorder uses the VBR (Variable Bit Rate) format to automatically adjust image quality to suit the recording scene. This technology causes fluctuations in the recording time of the media. Movies containing quickly moving and complex images are recorded at a higher bit-rate, and this reduces the overall recording time.
- Bit-rate (movie + audio, etc.), number of pixels, and aspect ratio of each recording mode of movies are as follows.
 - High definition image quality (HD)
 - PS: max. 28 Mbps 1,920 × 1,080/16:9
 - FX: max. 24 Mbps 1,920 × 1,080/16:9, 1,280 × 720/16:9
 - FH: approx. 17 Mbps (ave.) 1,920 × 1,080/16:9, 1,280 × 720/16:9
 - HQ: approx. 9 Mbps (ave.) 1,440 × 1,080/16:9, 1,280 × 720/16:9
 - LP: approx. 5 Mbps (ave.) 1,440 × 1,080/16:9
 - Standard definition image quality (DV)
 - approx. 29 Mbps (ave.) 720 × 480 (NTSC model), 720 × 576 (PAL model)/16:9, 4:3
- Number of pixels and aspect ratio of still images
 - Capturing a still image from a movie: 1,920 × 1,080 dots/16:9

Using your camcorder abroad

Power supply

You can use your camcorder in any country/region using the AC Adaptor supplied with your camcorder within the AC 100 V to 240 V, 50 Hz/60 Hz range.

Viewing on TV

Countries /regions that require NTSC color system

Bahama Islands, Bolivia, Canada, Central America, Chile, Colombia, Ecuador, Guyana, Jamaica, Japan, Korea, Mexico, Peru, Surinam, Taiwan, the Philippines, the U.S.A., Venezuela, etc.

Countries /regions that require PAL color system

Argentina, Australia, Austria, Belgium, Brazil, Bulgaria, China, Czech Republic, Denmark, Finland, France, Germany, Guiana, Holland, Hong Kong, Hungary, Iran, Iraq, Italy, Kuwait, Malaysia, Monaco, New Zealand, Norway, Paraguay, Poland, Portugal, Russia, Singapore, Slovak Republic, Spain, Sweden, Switzerland, Thailand, Ukraine, United Kingdom, Uruguay, etc.

Simple setting of the clock by time difference

When you are abroad, you can easily adjust the clock to the local time by setting the time difference. Select [AREA SET], then set the time difference (p. 99).

File/folder structure on the recording media

The file/folder structure is shown below. You do not usually need to acknowledge the file/folder structure, when recording/playing back movies and still images on the camcorder.

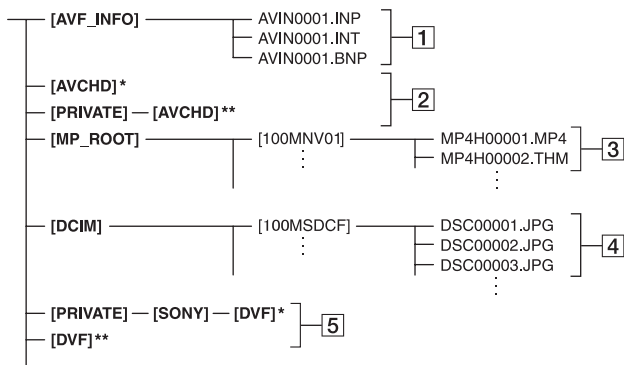

* “Memory Stick PRO Duo” media

**SD memory card, SDHC memory card, SDXC memory card

1 Image management files

When you delete the files, you cannot record/play back the images correctly. The files are defaulted as hidden files and not usually displayed.

2 HD movie management information folder

This folder contains recording data of high definition image quality (HD) movies. Do not try to open this folder or access the contents of this folder from a computer. Doing so might damage image files, or prevent image files from being played back.

3 MP4 movie files

These files contain recording data of MP4 movie. The file number goes up automatically.

4 Still image files (JPEG files)

The extension of the files is “.JPG”. The file numbers go up automatically. When the capacity of a file number exceeds 9999, another folder is created to store new still image files. The folder name goes up: [100MSDCF] → [101MSDCF]

5 DV movie management information folder

This folder contains recording data of standard image quality (DV) movie. Do not try to open this folder or access the contents of this folder from a computer. Doing so might damage image files, or prevent image files from being played back.

- Do not modify the files or folders on the camcorder from the computer. The image files may be destroyed or may not be played back. Operation is not guaranteed, if you perform this operation.
- When you delete image files, follow the steps on page 75. Do not delete the image files on the camcorder directly from the computer.
- Do not format the recording media in the camcorder using a computer. The camcorder may not operate correctly.
- Do not copy the files on the recording media from a computer. Operation is not guaranteed.
- Use the application software “Content Browser” to import data from the recording media to a computer.

Maintenance and precautions

About the AVCHD format

What is the AVCHD format?

The AVCHD format is a high definition digital video camera format used to record an HD (high definition) signal, using efficient data compression coding technology. The MPEG-4 AVC/H.264 format is adopted to compress video data, and the Dolby Digital or Linear PCM system is used to compress audio data. The MPEG-4 AVC/H.264 format is capable of compressing images at higher efficiency than that of the conventional image compressing format.

- Because the AVCHD format uses a data compression system, images may be distorted in scenes where the image, angle, or brightness changes drastically. This is not a malfunction.

Recording and playback on your camcorder

Based on the AVCHD format, your camcorder records with the HD (high definition) image quality.

Video signal*: MPEG-4 AVC/H.264

- NTSC model
1920 × 1080/60p, 1920 × 1080/60i,
1920 × 1080/24p, 1280 × 720/60p,
1440 × 1080/60i

- PAL model
1920 × 1080/50p, 1920 × 1080/50i,
1280 × 720/50p, 1440 × 1080/50i

Audio signal: Dolby Digital 2ch, Linear PCM 2 ch

Recording media: memory card (sold separately)

- * Data recorded in AVCHD format other than the above mentioned cannot be played back on your camcorder.

About the memory card

- A memory card formatted by a computer (Windows OS/Mac OS) does not have guaranteed compatibility with your camcorder.
- Data read/write speed may vary depending on the combination of the memory card and memory card compliant product you use.
- Damaged or lost image data will not be compensated for, and may occur in the following cases:
 - If you eject the memory card, turn the power off on your camcorder, or remove the battery pack for replacement while your camcorder is reading or writing image files on the memory card (while the access lamp is lit or flashing).
 - If you use the memory card near magnets or magnetic fields.
- It is recommended to make a back-up of important data on the hard disk of a computer.
- Do not attach a label or the like on memory card or a memory card adaptor.
- Do not touch, or allow metallic objects to come into contact with the terminals.
- Do not bend, drop or apply strong force to the memory card.
- Do not disassemble or modify the memory card.
- Do not let the memory card get wet.
- Be careful to keep memory card out of the reach of small children. There is danger that a child might swallow it.
- Do not insert anything other than the compliant size of memory card into the memory card slot. Doing so may cause a malfunction.
- Do not use or keep the memory card in the following locations:
 - Places subject to extremely high temperature, such as a car parked outside in the summer
 - Places under direct sunlight
 - Places with extremely high humidity or subject to corrosive gases

■ On the memory card adaptor

When inserting memory card into a memory card adaptor, make sure the memory card is inserted facing in the correct direction, then insert it all the way in. Note that improper use may cause a malfunction.

On image data compatibility

- Image data files recorded on a memory card by your camcorder conform to the “Design rule for Camera File system” universal standard established by the JEITA (Japan Electronics and Information Technology Industries Association).
- If you cannot use the memory card that has been used with another device, format it with your camcorder (p. 78). Note that formatting erases all information on the memory card.
- You may not be able to play back images with your camcorder:
 - When playing back image data modified on your computer.
 - When playing back image data recorded with other devices.

About the “Memory Stick” media

Types of “Memory Stick” media	Recording /Playback
“Memory Stick Duo” media (with MagicGate)	–
“Memory Stick XC-HG Duo” media	✓
“Memory Stick PRO Duo” media (Mark2)	✓
“Memory Stick PRO-HG Duo” media	✓

- This product supports parallel data transfer. However, the transfer speed may differ, depending on the type of media you use.
- This product cannot record or play data that uses “MagicGate” technology. “MagicGate” is a copyright protection technology that records and transfers the contents in an encrypted format.

About the “InfoLITHIUM” battery pack

Your camcorder operates only with an “InfoLITHIUM” L series battery pack of a large capacity, such as NP-F770/F970 (sold separately). You cannot use NP-F570. “InfoLITHIUM” L series battery packs have the  mark.

What is an “InfoLITHIUM” battery pack?

An “InfoLITHIUM” battery pack is a lithium-ion battery pack that has functions for communicating information related to operating conditions between your camcorder and a supplied AC Adaptor. The “InfoLITHIUM” battery pack displays the remaining battery time in % according to the operating situations of your camcorder.

To charge the battery pack

- Be sure to charge the battery pack before you start using your camcorder.
- We recommend charging the battery pack in an ambient temperature of from 10 °C to 30 °C (50 °F to 86 °F) until the charge lamp of the camcorder turns off. If you charge the battery pack outside of this temperature range, you may not be able to charge it efficiently.





To use the battery pack effectively

- Battery pack performance decreases when the ambient temperature is 10 °C (50 °F) or below, and the length of time you can use the battery pack becomes shorter. In that case, do one of the following to use the battery pack for a longer time.
 - Put the battery pack in a pocket to warm it up, and install it in your camcorder right before you start taking shots.
 - Use a large capacity battery pack: NP-F770/F970 (sold separately).

- Be sure to set the POWER switch to OFF when not recording or playing back on your camcorder. The battery pack is also consumed when your camcorder is in recording standby or playback pause.
- Have spare battery packs ready for 2 or 3 times the expected recording time, and make trial recordings before making the actual recording.
- Do not expose the battery pack to water. The battery pack is not water resistant.

About the remaining battery indicator

- Check the level with the following indicators and % displayed on the LCD screen.

Battery remaining indicator	%
	81% to 100%
	51% to 80%
	21% to 50%
	1% to 20%
	-

- The displayed level may not be correct under certain circumstances.
- When the power goes off even though the remaining battery time indicator indicates that the battery pack has enough power to operate, charge the battery pack fully again. Remaining battery time will be indicated correctly. Note, however, that the battery indication will not be restored if it is used in high temperatures for a long time, or if left in a fully charged state, or when the battery pack is frequently used. Use the remaining battery time indication as a rough guide only.

About storage of the battery pack

- If the battery pack is not used for a long time, fully charge the battery pack and use it up on your camcorder once a year to maintain proper function. To store the battery pack, remove it from your camcorder and put it in a dry, cool place.
- To discharge the battery pack on your camcorder completely, leave your camcorder in recording standby until the power goes off.

About battery life

- Battery capacity decreases over time and through repeated use. If decreased usage time between charges becomes significant, it is probably time to replace it with a new one.
- Each battery's life is governed by storage, operating and environmental conditions.

About charging the battery pack

- Use the AC Adaptor (supplied) to charge the designated batteries only. If you charge other types of batteries, those batteries may leak, heat up, burst, or give an electric shock, resulting in burns or injury.
- Remove the charged battery from the AC Adaptor.
- The CHARGE lamp of the supplied AC Adaptor flashes in 2 patterns as follows:
 - Fast-flashing...Turns on and off rapidly at about 0.15-second intervals.
 - Slow-flashing...Turns on and off alternately for about 1.5 seconds, and turns off completely for about 1.5 seconds. The lamp repeats this sequence.
- If the CHARGE lamp is fast-flashing, remove the battery that is being charged, and then re-attach the same battery again firmly. If the CHARGE lamp continues fast-flashing, the cause could be that the battery is damaged, or the battery is not a designated type. Check the battery to confirm whether it is a designated type or not. If it is a designated type, remove the battery first, and then attach a brand-new battery or another known-to-be-good battery to see if the AC Adaptor is working correctly. If the AC Adaptor is working correctly, the cause could be that the battery is damaged.
- If the CHARGE lamp is slow-flashing, the AC Adaptor is in standby mode and charging is suspended. When the ambient temperature is out of the appropriate temperature range for charging, the AC Adaptor suspends charging automatically and enters standby mode. When the ambient temperature returns to an appropriate temperature, the AC Adaptor restarts charging and the CHARGE lamp lights up. We recommend charging the battery pack in an ambient temperature of from 10 °C to 30 °C (50 °F to 86 °F).

About handling of your camcorder

On use and care

- Do not use or store the camcorder and accessories in the following locations.
 - Anywhere extremely hot or cold. Never leave them exposed to temperatures above 60 °C (140 °F), such as under direct sunlight, near heaters or in a car parked in the sun. They may malfunction or become deformed.
 - Near strong magnetic fields or mechanical vibration. The camcorder may malfunction.
 - Near strong radio waves or radiation. The camcorder may not be able to record properly.
 - Near AM receivers and video equipment. Noise may occur.
 - On a sandy beach or anywhere dusty. If sand or dust gets in your camcorder, the camcorder may malfunction. Sometimes this malfunction cannot be repaired.
 - Near windows or outdoors, where the LCD screen, the viewfinder, or the lens may be exposed to direct sunlight. This damages the inside of the viewfinder or the LCD screen.
 - Anywhere very humid.
- Operate your camcorder on DC 7.2 V (battery pack) or DC 8.4 V (AC Adaptor).
- For DC or AC operation, use the accessories recommended in these operating instructions.
- Do not let your camcorder get wet, for example, from rain or sea water. If your camcorder gets wet, it may malfunction. Sometimes this malfunction cannot be repaired.
- If any solid object or liquid gets inside the casing, unplug your camcorder and have it checked by a Sony dealer before operating it any further.
- Avoid rough handling, disassembling, modifying, physical shock, or impact such as hammering, dropping or stepping on the product. Be particularly careful of the lens.
- Do not use a deformed or damaged battery pack.
- Keep the POWER switch set to OFF when you are not using your camcorder.
- Do not wrap your camcorder with a towel, for example, and operate it. Doing so might cause heat to build up inside.
- When disconnecting the power cord (mains lead), pull it by the plug and not the lead.

- Do not damage the power cord (mains lead) such as by placing anything heavy on it.
- Keep metal contacts clean.
- Keep the Wireless Remote Commander and button-type battery out of children's reach. If the battery is accidentally swallowed, consult a doctor immediately.
- If the battery electrolytic liquid has leaked,
 - consult your local authorized Sony service facility.
 - wash off any liquid that may have contacted your skin.
 - if any liquid gets in your eyes, wash with plenty of water and consult a doctor.

■ When not using your camcorder for a long time

- Turn on the camcorder and record and play back images about once a month to keep it in an optimum state for a long time.
- Use up the battery pack completely before storing it.

Moisture condensation

If your camcorder is brought directly from a cold place to a warm place, moisture may condense inside your camcorder and cause a malfunction of your camcorder.

■ If moisture condensation has occurred

Leave your camcorder for about 1 hour without turning it on.

■ Note on moisture condensation

Moisture may condense when you bring your camcorder from a cold place into a warm place (or vice versa) or when you use your camcorder in a humid place as shown below.

- When you bring your camcorder from a ski slope into a place warmed up by a heating device.
- When you bring your camcorder from an air conditioned car or room into a hot place outside.
- When you use your camcorder after a squall or a shower.
- When you use your camcorder in a hot and humid place.

■ How to avoid moisture condensation

When you bring your camcorder from a cold place into a warm place, put your camcorder in a plastic bag and seal it tightly. Remove the bag when the air temperature inside the plastic bag has reached the ambient temperature (after about 1 hour).

LCD screen

- Do not exert excessive pressure on the LCD screen, as it may cause damage.
- If your camcorder is used in a cold place, a residual image may appear on the LCD screen. This is not a malfunction.
- While using your camcorder, the back of the LCD screen may heat up. This is not a malfunction.

■ To clean the LCD screen

The LCD screen is covered with a coating. The coating may be peeled off by scratching or rubbing. Maintain the LCD screen as follows.

- Wipe fingerprints or hand cream off the LCD screen as soon as possible, as they may cause the coating to peel off.
- If you rub the LCD screen hard, even with a tissue, the coating may be damaged.
- Before wiping the LCD screen, blow dust or sand off with a dust blower, etc.
- Wipe dirt off the LCD screen with a clean, soft cloth, such as an eye glass cleaning cloth, etc.

■ To adjust the touch panel (CALIBRATION)

The buttons on the touch panel may not work correctly. If this happens, follow the procedure below. It is recommended that you connect your camcorder to the wall outlet (wall socket) using the supplied AC Adaptor during the operation.

- ① Press the MENU button → select  (OTHERS) → [CALIBRATION] with the SEL/PUSH EXEC dial.
- ② Touch “x” displayed on the LCD screen with the corner of memory card or the like 3 times.



ⓘ Notes

- If you did not press the right spot, try the calibration again.
- Do not use a sharp-pointed object for calibration. Doing so may damage the LCD screen.
- You cannot perform the calibration when the LCD screen is turned around, or facing up and closed to the camcorder

Casing

- If the casing is soiled, clean the camcorder body with a soft cloth lightly moistened with water, and then wipe the casing with a dry soft cloth.
- Avoid the following to prevent damage to the finish.
 - Using chemicals such as thinner, benzene, alcohol, chemical cloths, repellent, insecticide and sunscreen.
 - Handling with above substances on your hands.
 - Leaving the casing in contact with rubber or vinyl objects for a long period of time.

Care and storage of the lens

- Wipe the surface of the lens clean with a soft cloth in the following instances:
 - When there are fingerprints on the lens surface.
 - In hot or humid locations
 - When the lens is exposed to salty air such as at the seaside.
- Store in a well-ventilated location subject to little dirt or dust.
- To prevent mold, periodically clean the lens as described above.

Charging the pre-installed rechargeable battery

Your camcorder has a pre-installed rechargeable battery to retain the date, time, and other settings even when the POWER switch is set to OFF. The pre-installed rechargeable battery is always charged while your camcorder is connected to the wall outlet (wall socket) via the AC Adaptor or while the battery pack is attached. The rechargeable battery will be fully discharged in about **3 months** if you do not use your camcorder at all without the AC Adaptor connected or the battery pack attached. Use your camcorder after charging the pre-installed rechargeable battery.

However, even if the pre-installed rechargeable battery is not charged, the camcorder operation will not be affected as long as you are not recording the date.

■ Procedures

Connect your camcorder to a wall outlet (wall socket) using the supplied AC Adaptor, and leave it with the POWER switch set to OFF for more than 24 hours.

Removing dust from inside the viewfinder

- ① Slide down the viewfinder release lever and hold it at the position, then lift the eye piece of the viewfinder as indicated with the arrow in the illustration.

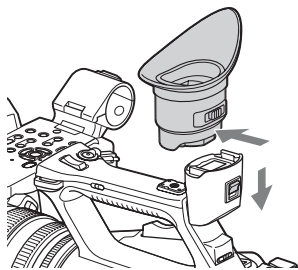

- ② Remove dust inside the eye piece and viewfinder with a blower.

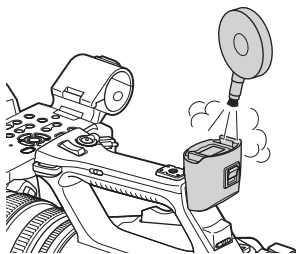

Note on disposal/transfer of the recording media

Even if you format the recording media or delete data from the recording media using your camcorder or computer, you cannot delete data from the recording media completely.

When you transfer the recording media, it is recommended that you delete the data completely using commercially available data deletion software to prevent the recovery of your data. Also, when you dispose of the recording media, it is recommended that you destroy the actual body of the recording media.

Specifications

System

Video signal

NTSC color, EIA standards
HDTV 1080/60i, 1080/60p, 720/60p specification (models with the NTSC color system)
PAL color, CCIR standards
HDTV 1080/50i, 1080/50p, 720/50p specification (models with the PAL color system)

Video recording system

HD image quality: MPEG-4 AVC/
H.264 AVCHD format Ver. 2.0 compatible
SD image quality: DV standard compatible

Audio recording system*

Linear PCM 2ch (48 kHz 16-bit)
Dolby Digital 2ch (48 kHz 16-bit)
Dolby Digital Stereo Creator employed

* Only Linear PCM 2ch (48 kHz 16-bit) in DV mode.

Still image recording system

DCF Ver. 2.0 Compatible
Exif Ver. 2.3 Compatible
MPF Baseline Compatible

Recording media (movies/still images)

“Memory Stick PRO Duo” media (not recommended for the standard definition image quality (DV) and S&Q recording)
SD card (AVCHD recording: Class 4 or faster is recommended/DV recording: Class 6 or faster is recommended/S&Q recording: Class 10 or faster is recommended.)

Image device

6.4 mm (1/2.8 type) Exmor 3CMOS sensor
Gross: Approx. 2 410 000 pixels
Effective (movie, 16:9 mode):
Approx. 2 070 000 pixels
Effective (movie, 4:3 mode):
Approx. 1 560 000 pixels

Lens

G Lens
20 × (Optical)
Approx. 40 × (including clear image zoom)
Approx. 320 × (including digital zoom)
f=4.1 mm - 82.0 mm (3/16 in. - 3 1/4 in.)
When converted to a 35 mm still camera*
28.8 mm - 576 mm (1 3/16 in. - 22 3/4 in.) (16:9 mode)
35.2 mm - 705 mm (1 7/16 in. - 27 7/8 in.) (4:3 mode)
F1.6 - F3.4
Filter diameter: 72 mm (2 7/8 in.)

* When [STEADYSHOT] is set to [STANDARD] or [OFF]

Color temperature

[AUTO]
 (one push) A/B
[INDOOR] (3 200K)
[OUTDOOR] (5 600K)

Minimum illumination

1.2 lx (lux) with Shutter Speed 1/30, auto gain control, auto iris (F1.6) (NTSC model)
1.0 lx (lux) with Shutter Speed 1/25, auto gain control, auto iris (F1.6) (PAL model)

Video light

Maximum illumination: Approx. 800 lx (lux) (0.5 m)
Approx. 200 lx (lux) (1.0 m)
Irradiation angle (wide angle distribution): Approx. 30°
Color temperature: Approx. 5 500 K

Input/output connectors

VIDEO OUT jack

BNC connector
1 Vp-p, 75 Ω (ohms) unbalanced, sync negative

Specifications (Continued)

AUDIO OUT jacks

Pin connectors
-10 dBu (at load impedance 47 k Ω (kilohms)), Output impedance with less than 2.2 k Ω (kilohms)
(0 dBu = 0.775 Vrms)

REMOTE jack

Stereo mini-minijack (\varnothing 2.5 mm)

HDMI OUT jack

HDMI Connector (Type A)

USB jack

mini-AB

🎧 (headphones) jack

Stereo minijack (\varnothing 3.5 mm)

INPUT1/INPUT2 jacks

XLR 3-pin \times 2, female,
MIC: -48 dBu/3 k Ω (kilohms)
LINE: +4 dBu/10 k Ω (kilohms)
(0 dBu = 0.775 Vrms)

Screen

LCD screen

Picture: 8.8 cm (3.5 type, aspect ratio 16:9)
Total dot number: 921 600 (1 920 \times 480)

Viewfinder

Picture: 1.1 cm (0.45 type, aspect ratio 16:9)
Total dot number: Approx. 1 226 880 (852 \times 3 [RGB] \times 480)

General

Power requirements

DC 7.2 V (battery pack)
DC 8.4 V (AC Adaptor)

Average power consumption*

During camera recording using the viewfinder with normal brightness.
NTSC model: Approx. 6.4 W
PAL model: Approx. 6.3 W
(With an optional XLR Microphone)

During camera recording using the LCD with normal brightness.
NTSC model: Approx. 6.9 W
PAL model: Approx. 6.7 W
(With an optional XLR Microphone)

Operating temperature

0 °C to 40 °C (32 °F to 104 °F)

Storage temperature

-20 °C to +60 °C (-4 °F to +140 °F)

Dimensions (approx.)

Camcorder body only (including the projecting parts):
174.5 mm \times 187.5 mm \times 342 mm
(6 7/8 in. \times 7 1/2 in. \times 13 1/2 in.) (w/h/d) (with the lens hood with lens cover)
When recording (including the projecting parts):
174.5 mm \times 193 mm \times 393 mm
(6 7/8 in. \times 7 5/8 in. \times 15 1/2 in.) (w/h/d) (With the accessories (lens hood with lens cover, large eyecup, grip belt (excluding the belt) attached.))

Mass (approx.)

2 210 g (4 lb 14 oz)
(with the lens hood with lens cover)
When recording:
2 440 g (5 lb 7 oz) (With the accessories (battery pack (NP-F770), lens hood with lens cover, large eyecup attached.))

* When the video light is used, the average power consumption increases approximately 3.4 W.

AC Adaptor AC-L100C*1

Power requirements

AC 100 V - 240 V, 50 Hz/60 Hz

Power consumption

18 W

Output voltage

DC 8.4 V*2

Operating temperature

0 °C to 40 °C (32 °F to 104 °F)

Storage temperature

-20 °C to +60 °C (-4 °F to +140 °F)

Dimensions (approx.)

48 mm × 29 mm × 81 mm
(1 15/16 in. × 1 3/16 in. × 3 1/4 in.)
(w/h/d) excluding the projecting parts

Mass (approx.)

170 g (6.0 oz) excluding the power cord
(mains lead)

*1 When using the AC adaptor AC-L100C, the video light function cannot be used.

*2 See the label on the AC Adaptor for other specifications.

Wireless LAN**Supported standard**

IEEE 802.11 b/g/n

Frequency

2.4 GHz

Supported security protocols

WEP/WPA-PSK/WPA2-PSK

NFC

NFC Forum Type 3 Tag compliant

Design and specifications of your camcorder and accessories are subject to change without notice.

- Manufactured under license from Dolby Laboratories.

On trademarks

- “NXCAM” logo is a trademark of Sony Corporation.
- “AVCHD Progressive” and “AVCHD Progressive” logotype are trademarks of Panasonic Corporation and Sony Corporation.
- “Memory Stick”, “”, “Memory Stick Duo”, “MEMORY STICK DUO”, “Memory Stick PRO Duo”, “MEMORY STICK PRO DUO”, “Memory Stick PRO-HG Duo”, “MEMORY STICK PRO-HG DUO”, “Memory Stick XC-HG Duo”, “MEMORY STICK XC-HG DUO”, “MagicGate”, “MAGIC GATE”, “MagicGate Memory Stick”, “MagicGate Memory Stick Duo” “PlayMemories Mobile” and “PlayMemories Mobile” logo are trademarks of Sony Corporation.
- “InfoLITHIUM” is a trademark of Sony Corporation.
- “BRAVIA” is a trademark of Sony Corporation.
- Blu-ray Disc™ and Blu-ray™ are trademarks of the Blu-ray Disc Association.
- Dolby and the double-D symbol are trademarks of Dolby Laboratories.
- Microsoft, Windows, and Windows Vista are trademarks or registered trademarks of U.S. Microsoft Corporation in the U.S. and other countries.
- Mac and Mac OS are registered trademarks of Apple Inc. in the U.S. and other countries.
- iPhone and iPad are trademarks of Apple Inc., registered in the U.S. and other countries.
- iOS is a registered trademark or trademark of Cisco Systems, Inc. and/or its affiliates in the United States and certain other countries
- The terms HDMI and HDMI High-Definition Multimedia Interface, and the HDMI Logo are trademarks or registered trademarks of HDMI Licensing LLC in the United States and other countries.
- Intel, Pentium, and Intel Core are registered trademarks or trademarks of Intel Corporation in the United States and other countries.
- Android, Google Play are trademarks of Google Inc.
- Wi-Fi, the Wi-Fi logo, Wi-Fi PROTECTED SET-UP are registered trademarks of the Wi-Fi Alliance.
- The N Mark is a trademark or registered trademark of NFC Forum, Inc. in the United States and in other countries.

Specifications (Continued)

- Adobe, the Adobe logo, and Adobe Acrobat are either registered trademarks or trademarks of Adobe Systems Incorporated in the United States and/or other countries.
- SDXC logo is a trademark of SD-3C, LLC.

All other product names mentioned herein may be the trademarks or registered trademarks of their respective companies. Furthermore, ™ and “®” are not mentioned in each case in this manual.

Notes on the License

ANY USE OF THIS PRODUCT OTHER THAN CONSUMER PERSONAL USE IN ANY MANNER THAT COMPLIES WITH THE MPEG-2 STANDARD FOR ENCODING VIDEO INFORMATION FOR PACKAGED MEDIA IS EXPRESSLY PROHIBITED WITHOUT A LICENSE UNDER APPLICABLE PATENTS IN THE MPEG-2 PATENT PORTFOLIO, WHICH LICENSE IS AVAILABLE FROM MPEG LA, L.L.C., 250 STEELE STREET, SUITE 300, DENVER, COLORADO 80206.

THIS PRODUCT IS LICENSED UNDER THE AVC PATENT PORTFOLIO LICENSE FOR THE PERSONAL USE OF A CONSUMER OR OTHER USES IN WHICH IT DOES NOT RECEIVE REMUNERATION TO

(i) ENCODE VIDEO IN COMPLIANCE WITH THE AVC STANDARD (“AVC VIDEO”) AND /OR

(ii) DECODE AVC VIDEO THAT WAS ENCODED BY A CONSUMER ENGAGED IN A PERSONAL ACTIVITY AND/OR WAS OBTAINED FROM A VIDEO PROVIDER LICENSED TO PROVIDE AVC VIDEO.

NO LICENSE IS GRANTED OR SHALL BE IMPLIED FOR ANY OTHER USE.

ADDITIONAL INFORMATION MAY BE OBTAINED FROM MPEG LA, L.L.C. SEE <[HTTP://WWW.MPEGLA.COM](http://www.mpegla.com)>

Software is installed in your camcorder. We provide this software based on the license agreements of the copyright owners. Based on requests by the owners of copyright of these software applications, we have an obligation to inform you of the following.

Please read the files in the “LICENSE” folder on the CD-ROM. You will find licenses (in English) for the software.

On GNU GPL/LGPL applied software

The software that is eligible for the following GNU General Public License (hereinafter referred to as “GPL”) or GNU Lesser General Public License (hereinafter referred to as “LGPL”) are included in the camcorder.

This informs you that you have a right to have access to, modify, and redistribute source code for these software programs under the conditions of the supplied GPL/LGPL.

Source code is provided on the web. Use the following URL to download it. When downloading the source code, select HXR-NX3 as the model for your camcorder.

<http://www.sony.net/Products/Linux/>

We would prefer you do not contact us about the contents of source code.

Please read the files in the “LICENSE” folder on the CD-ROM. You will find licenses (in English) for the software.

Index

A

AC Adaptor 18
Accessory shoe 22
Accessory shoe plate 22
AE SHIFT 87, 108
AGC LIMIT 86
AIRPLANE MODE 98
AREA SET 99
ASPECT 94
ASSIGN BUTTON 62
AUDIO LEVEL DISPLAY
..... 95
AUDIO LIMIT 91
AUDIO SET menu 91
AUTO MODE SET 46
AUTO SLOW SHUTTER 88

B

Battery 18
BEEP 100
BLACK GAMMA 55
BLACK LEVEL 55
Button-type lithium battery
..... 10

C

CALIBRATION 123
CAMERA DATA DISPLAY
..... 95
CAMERA PROFILE 99
CAMERA SET menu 86
CENTER 94
Charging time 19
CHG lamp 18
CLOCK SET 22
COLOR BAR 88, 108
COLOR DEPTH 57
COLOR LEVEL 57
COLOR MODE 56
COLOR PHASE 57

Connect

External media device
..... 102
Recorder 104
TV 71
CONVERSION LENS 88
COPY 76
CTRL W/SMARTPHONE
..... 49

D

Data code 69
Date and time 12, 23
DATE REC 100
DELETE 75
DETAIL 58
DISPLAY OUTPUT 96
DISPLAY SET menu 93
DIVIDE 74
DOWN CONVERT TYPE
..... 90
DV MODE 36
DV WIDE CONVERT 90
DV WIDE REC 89

E

EDIT DEVICE NAME 98
Expanded focus 33

F

FACE DETECTION 34
Focus 32
FOCUS DISPLAY 95
Focus hold 32
FOCUS MAG RATIO 94
FREE RUN 97

G

Gain 39
GAIN SET 86
GAMMA 55

GUIDEFRACTION 94

H

Handle record button 29
Handle zoom 31
Handle zoom lever 31
Handle zoom switch 31
HD AUDIO FORMAT 91
HD REC FORMAT 35
HDMI 89
HDMI TC OUTPUT 90
Headphone 45
HEADPHONE OUT 91
HISTOGRAM 93

I

Image database file 80
“InfoLITHIUM” battery pack
..... 120
INPUT1 TRIM 92
INPUT1 WIND 92
INPUT2 TRIM 92
INPUT2 WIND 92
INT MIC SET 91
IRIS 38
Items 83

K

KNEE 56

L

LANGUAGE 100
Large eyecup 24
Last Scene Review 61
LCD BRIGHT 96
Lens 21, 123
Lens cover lever 21

M

MARKER 94, 108
MEDIA FORMAT 78

- Memory card.....25, 119
 Insert/Eject.....25
- “Memory Stick” media
120
- “Memory Stick PRO Duo”
 media120
- Menu83
- AUDIO SET menu91
 - CAMERA SET menu.....86
 - DISPLAY SET menu
93
 - Items83
 - NETWORK SET menu
98
 - OTHERS menu.....99
 - REC/OUT SET menu...89
 - TC/UB SET menu97
 - Using81
- MIC+48V.....43
- Moisture condensation.....122
- Movie.....27
- ## N
- ND filter.....40
- NETWORK SET menu98
- NFC48
- ## O
- OPERATION TIME.....101
- OTHERS menu.....99
- Output resolution72
- Outside power source20
- ## P
- PEAKING.....93, 108
- PHOTO CAPTURE.....77
- Picture profile53
- Playback.....64
- Power zoom lever31
- Pre-installed rechargeable
 battery124
- PROTECT74
- Push auto focus32
- ## R
- REC BUTTON SET.....29
- REC LAMP[F]100
- REC LAMP[R]100
- REC RUN97
- REC SET.....89
- Record button29
- Recording27
- Recording format35
- Recording time115
- REC/OUT SET menu.....89
- Relay recording28
- REMOTE CONTROL100
- REPAIR IMAGE DB FILE
80
- RESET button9
- ## S
- SAFETY ZONE94
- SCENE SELECTION SET
47
- Screen indicators11
- Self-diagnosis display112
- SEND TO SMARTPHONE
50
- Shoulder strap8
- SHUTTER DISPLAY.....95
- Shutter speed39
- Simultaneous recording.....29
- SIMUL/RELAY REC
29
- Slow & Quick Motion.....60
- Specifications125
- SPOT FOCUS33
- SPOT METER88
- SPOT METER/FOCUS88
- SSID/PW RESET.....98
- Status check.....70
- STEADYSHOT87
- Still image77
- SUMMERTIME99
- Supplied accessories.....17
- S&Q button.....60
- S&Q MOTION.....61
- ## T
- TC FORMAT97
- TC MAKE97
- TC PRESET.....59, 108
- TC RUN.....97
- TC/UB SET menu97
- Telephoto31
- tone89
- Trademark.....127
- Transmitter10
- Troubleshooting.....105
- TV71
- ## U
- UB PRESET59
- UB TIME REC97
- USB CONNECT101
- Using your camcorder abroad
117
- ## V
- VERSION DISPLAY101
- VF BACKLIGHT96
- VIDEO OUT89
- Viewfinder.....24
- Viewfinder lens adjustment
 lever24
- Volume66
- ## W
- Warning indicators112
- WB OUTDOOR LEVEL87
- WB PRESET86
- WB SHIFT.....57
- WB TEMP SET87
- White balance41

Index (Continued)

Wide angle.....	31
Wi-Fi	47
Wireless Remote Commander	10

X

XLR AGC LINK.....	91
XLR SET.....	91

Z

ZEBRA.....	93, 108
Zoom	31
ZOOM DISPLAY	95
ZOOM SET	87

<http://www.sony.net/>

© 2014 Sony Corporation

Printed in Japan

