

Perfecting the moment.

zhiyun-tech.com



SMOOTH-Q

User Guide V1.2

Contents

■ Packing List	1
■ Disclaimer and Warning	2
■ Battery Safety Guidelines	4
■ Quick Start Guide	8
■ Charging Guidelines	9
■ APP Download and Installation	10
■ SmartphoneInstallation	11
■ Balance Adjustment	12
■ Start Up	13
■ Introducing Gimbal Control Modes	15
■ Introducing Connection Ports and Various Operations	16
■ APP Operations	17
■ Usage of Main Accessories	19
■ Initialization and Calibration	23
■ Product Specifications	24
■ Warranty Card	25

The product package comes with the following items. In case that any item is found missing, please contact ZHIYUN or your local selling agent.



SMOOTH-Q
3-Axis Smartphone
Stabilizer 1



Micro USB Cable 1

Thank you for using ZHIYUN SMOOTH-Q. The information contained herein affects your safety and your legal rights and responsibilities. Read this entire document carefully to ensure proper configuration before use. Failure to read and follow the instructions and warnings herein may result in serious injury to you or bystanders, or damage to your device or property.

ZHIYUN reserves the right of final explanation for this document and all relevant documents relating to SMOOTH-Q, and the right to make changes at any time without notice. Please visit www.zhiyun-tech.com for the latest product information.

By using this product, you hereby signify that you have read this document carefully and that you understand and agree to abide by the terms and conditions herein. You agree that you are solely responsible for your own conduct while using this product, and for any consequences thereof. You agree to use this product only for purposes that are proper and in accordance with all terms, precautions, practices, policies and guidelines ZHIYUN has made and may make available.

ZHIYUN™ accepts no liability for damage, injury or any legal responsibility incurred directly or indirectly from the use of this product. Users shall observe safe and lawful practices including, but not limited to, those set forth herein.

ZHIYUN™ is the trademark of Guilin Zhishen Information Technology Co., Ltd. (hereinafter referred to as "ZHIYUN" or "ZHIYUN TECH") and its affiliates. All product names or marks referred to hereunder are trademarks or registered trademarks of their respective holders.

Glossary

The following terms are used throughout the product literature to indicate various levels of potential harm when operating this product.

WARNING: Procedures, which if not properly followed, may incur property damage, grave accident, or serious injury.

CAUTION: Procedures, which if not properly followed, may incur property damage and serious injury.

NOTICE: Procedures, which if not properly followed, may incur property damage or minor injury.

WARNING

Read the ENTIRE User Guide to become familiar with the features of this product before operating. Failure to operate the product correctly can result in damage to the product or personal property and cause serious injury. This is a sophisticated product. It must be operated with caution and common sense and requires some basic mechanical ability. Failure to operate this product in a safe and responsible manner could result in injury or damage to the product or other property. This product is not intended for use by children without direct adult supervision. DO NOT use with incompatible components or in any way otherwise as mentioned or instructed in the product documents provided by ZHIYUN. The safety guidelines herein contain instructions for safety, operation and maintenance. It is essential to read and follow all of the instructions and warnings in the User Guide, prior to assembly, setup or use, in order to operate the product correctly and avoid damage or serious injury.

Safe Operation Guidelines

- **CAUTION:**
 - 1.SMOOTH-Q is a high-precision control device. Damage may be caused to SMOOTH-Q if it is dropped or subject to external force, and this may result in malfunction.
 - 2.Make sure the rotation of the gimbal axes is not blocked by external force when SMOOTH-Q is turned on.
 - 3.SMOOTH-Q is not waterproof. Prevent contacts of any kind of liquid or cleaner with SMOOTH-Q. It is recommended to use dry cloth for cleaning.
 - 4.Protect SMOOTH-Q from dust and sand during use.
- **NOTICE:**

Keep the handle stable when SMOOTH-Q is powered on, as shaking may cause failure to start up.

This document is subject to change.
 ZHIYUN™ is a trademark of ZHIYUN TECH.
 Copyright©2017 ZHIYUN TECH. All rights reserved.

Disclaimer

This Battery Safety Guidelines and all relevant documents are subject to change at the sole discretion of ZHIYUN TECH. ZHIYUN TECH reserves the right to make changes at any time without notice. For updated product information, please visit ZHIYUN's official website.

Glossary

- **WARNING:** Procedures, which if not properly followed, may incur property damage, grave accident, or serious injury.
- **CAUTION:** Procedures, which if not properly followed, may incur property damage and serious injury.

WARNINGS

Read the ENTIRE User Guide to become familiar with the features of this product before operating. Failure to operate the product correctly can result in damage to the product or personal property and cause serious injury. This is a sophisticated product. It must be operated with caution and common sense and requires some basic mechanical ability. Failure to operate this product in a safe and responsible manner could result in injury or damage to the product or other property. This product is not intended for use by children without direct adult supervision. DO NOT use with incompatible components or in any way otherwise as mentioned or instructed in the product documents provided by ZHIYUN. The safety guidelines herein contain instructions for safety, operation and maintenance. It is essential to read and follow all of the instructions and warnings in the User Guide, prior to assembly, setup or use, in order to operate the product correctly and avoid damage or serious injury.

- **WARNING**

To avoid fire, serious injury, and property damage, observe the following safety guidelines when using, charging, or storing your batteries.

Battery Use

- 1.Prevent the batteries to come into contact with any kind of liquid. Do not leave batteries out in the rain or near a source of moisture. Do not drop the battery into water. If the inside of the battery comes into contact with water, chemical decomposition may occur, potentially resulting in the battery catching on fire, and may even lead to an explosion.
- 2.If the battery falls into water with the stabilizer during use, take it out immediately and put it in a safe and open area. Maintain a safe distance from the battery until it is completely dry. Never use the battery again, and dispose of the battery properly as described in the Battery Disposal section below.
- 3.If the battery catches fire, use water, water spray, sand, fire blanket, dry powder, or carbon dioxide fire extinguisher immediately to put out the fire. Please extinct the fire by applying the methods recommended above according to the actual situation.
- 4.Never use non-ZHIYUN batteries. If replacement or backup is needed, please purchase new batteries from ZHIYUN's official website or authorized channels. ZHIYUN takes no responsibility for any damage caused by non-ZHIYUN batteries.
- 5.Never use or charge swollen, leaky, or damaged batteries. Never use or charge if the battery smells, or overheats (exceeding maximum temperature of 160°F / 71°C). If your batteries are abnormal, contact ZHIYUN or a ZHIYUN authorized dealer for further assistance.
- 6.The battery should be used within the temperature range from -10°C to 50°C. Use the battery in environments above 50°C can lead to a fire or explosion. Use of battery below -10°C can lead to serious battery damage.
- 7.Do not use the battery in strong electrostatic or electromagnetic environments. Otherwise, the battery protection board may malfunction.
- 8.Do not disassemble or use any sharp object to puncture the battery in any way. Otherwise, the battery may leak, catch fire or explode.
- 9.Do not mechanically strike, crush, or throw the battery. Do not place heavy objects on the battery or charger.
- 10.Electrolytes inside the battery are highly corrosive. In case of accidental contact of any electrolytes with your skin or eyes, rinse immediately with water for at least 15 minutes and seek medical advice as soon as possible.
- 11.Do not use the battery if it has been involved in a crash or heavy impact.
- 12.Do not heat the battery and never put the battery in a microwave oven or in a pressurized container.

- 13.Do not place the battery cell on a conductive surface (such as a metal desk surface).
- 14.Prevent use of wires or other metal objects that could cause positive and negative short-circuit to the battery.
- 15.If the battery terminal is dirty, wipe it with a clean, dry cloth. Otherwise it will cause a bad battery connection, which may result in energy loss or charging failure.

Battery Charging

- 1.Do not attach the batteries to a wall outlet or car charger socket directly. Always use a ZHIYUN approved adapter for charging. ZHIYUN takes no responsibility if the battery is charged using a non-ZHIYUN charger.
- 2.Do not put the battery and charger near flammable materials or on flammable surfaces (such as carpet or wood). Never leave the battery unattended during charging to prevent any accident.
- 3.Do not charge the battery immediately after use, because the battery temperature may be too high. Do not charge the battery until it cools down to normal room temperature. Charging the battery with its temperature over 40°C or lower than 15°C may lead to leakage, overheating, or damage.
- 4.Examine the charger before use, make sure there is no damage to the enclosure, cord, plug, or other parts. Never use a damaged charger. Do not clean the charger with any liquid containing alcohol or other flammable solvents. Disconnect the charger when not in use.

Battery Storage

- 1.Keep batteries out of the reach of children and pets.
- 2.Do not leave the battery near heat sources such as a furnace or heater, or inside of a vehicle on hot days. Never expose the battery in any environment with temperature of over 60°C. The ideal storage temperature is 22°C-28°C.
- 3.Store batteries in a dry environment.
- 4.Do not leave the battery unused for too long after it has been completely discharged to prevent over-discharge of battery which may result in battery damage and permanent failure.

Battery Maintenance

- 1.Never use the battery when the temperature is too high or too low.
- 2.Do not store the battery in any environment with a temperature of over 60°C.

Battery Maintenance

1. Never use the battery when the temperature is too high or too low.
2. Do not store the battery in any environment with a temperature of over 60°C.

Transportation Notice

1. Discharge the battery power to 5% or lower before carrying the battery on an airline flight. Only discharge the battery in a fireproof location, ideally in a dry and open area.
2. Do not store or transport batteries together with metal objects such as eyeglasses, watch, and jewelries, etc.
3. Do not transport damaged batteries. When transporting, be sure to discharge the battery to less than 50%.

Battery Disposal

Dispose of the battery in specific recycling boxes only after a complete discharge. Do not put away the battery in regular trash containers. Strictly follow your local regulations regarding the disposal and recycling of batteries.

Battery Use

Make sure the batteries are fully charged before each time of use.

Battery Charging

The battery will stop charging automatically when it is full. Disconnect the batteries from the charger when fully charged.

Battery Storage

1. Discharge the battery to 40%-65% if it will NOT be used for over 10 days. This can greatly extend the battery life.
2. The battery enters hibernation mode when voltage gets too low. Charge the battery will bring it out of hibernation.
3. Remove batteries from the stabilizer when not in use and store them in a specialized container.

Battery Maintenance

Never over-discharge, as this may lead to battery cell damage. Battery performance may be affected if not used for a long time. Charge and discharge the battery once every 3 months to keep it active.

Battery Disposal

If the battery cannot be fully discharged, do not leave it in the recycling box, but contact a professional battery disposal/recycling agent for further assistance.

Get to Know SMOOTH-Q

Check the product package before use, make sure that all items below have arrived with the product. In case that any item is found missing, please contact ZHIYUN or your local selling agent.

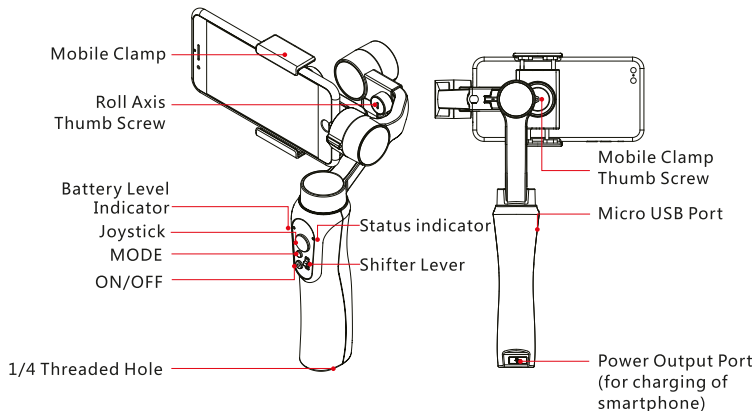

Payload : 75g-200g
 Horizontal Arm Adjustment Range : 15mm(0.6 inch)
 Mounting Clamp Supporting Range : 58-85mm(2.3-3.3 inch)

Mobile Charging

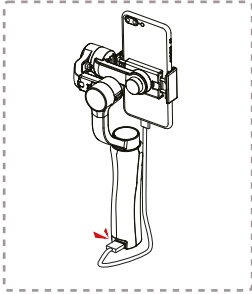

The USB Port at the bottom of the stabilizer handle can be used for convenient charging of your smartphone while mounted on the stabilizer, which guarantees extended working duration both for the stabilizer and the mounted smartphone.

■ NOTICE

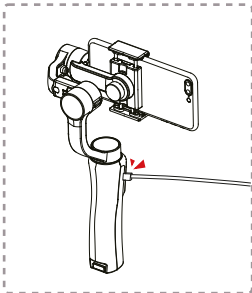

An L-shape charging connector is required when the smartphone is mounted horizontally on the mobile clamp.

Stabilizer Charging



Connect the Micro USB Port on the side of SMOOTH-Q' s handle to a power source via the Micro USB charging cable for direct charging of SMOOTH-Q .

Reading Tips

Legends:  Hints and tips  Important

APP Download and Installation



Download the APP from the “Downloads” page on ZHIYUN's official website www.ZHIYUN-TECH.com, or by directly scanning the QR code on the left (Android 5.0 above or iOS9.0 above required) to download. Users can download the APP by searching “ZY Play” in Google Play or APP Store.

 **The ZHIYUN APP is subject to regular update, try out now to discover more functions.**

Smartphone Installation

Push and hold open the camera clamp, slide the smartphone in as close as possible against the tilt axis motor, and clamp on.

⚠ Do not power on the stabilizer before the smartphone is properly mounted.

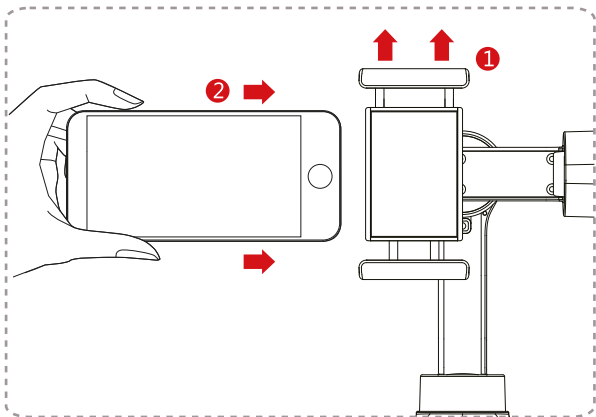

Gravity Center Adjustment

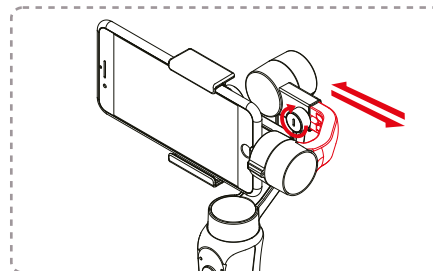

If the smartphone fails to stay in level and keeps tilting when mounted, loosen the Roll Axis (Y Axis) Thumb Screw to adjust the gravity center by sliding the horizontal arm (as marked red in the Figure) until the smartphone stays still and vertical on the tilt axis. Tighten the Thumb Screw after the smartphone is well balanced in level to ensure normal operations.

⚠ Proper adjustment of gravity center ensures better power saving during operation. The stabilizer may still function well when the gravity center is not properly configured, however, it may lead to more power consumption on the motors, and can greatly affect the torque output.

Switching Mobile Mounting Direction

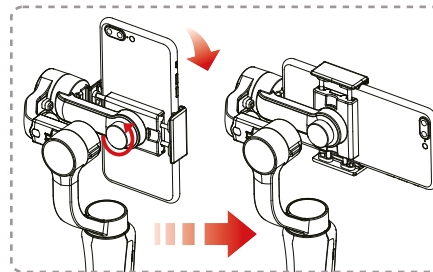

Loosen the Mobile Clamp Thumb Screw on the back and rotate the clamp with the smartphone mounted to the desired direction (either in horizontal or vertical). Tighten the Thumb Screw to ensure normal operations.

Control Panel Introduction

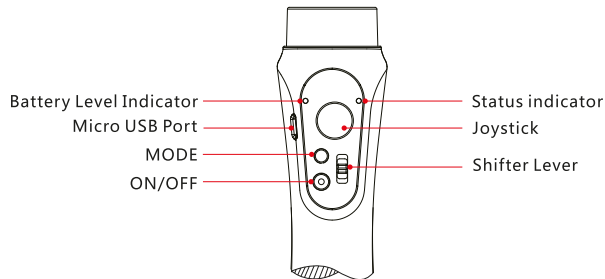

Joystick Operation

Joystick controls the smartphone movement when pushed or pulled up/down and left/right.

Power ON/OFF

Power on the stabilizer by pressing the Power button for about 3 sec. The Power button is used for camera shooting controls when paired to the Mobile APP.

Micro USB Port

Connect the stabilizer with a USB power source using a Micro USB cable for charging. Connect the stabilizer with a computer using a Micro USB cable for firmware upgrade and on-line calibration.

Battery Level Indicator

Shines BLUE light when the stabilizer is in normal operation, the flashing frequency of the BLUE light indicates the current battery level:

- Quick flash 4 times for battery level of 76%-100%.
- Quick flash 3 times for battery level of 51%-75%.
- Quick flash 2 times for battery level of 26%-50%.
- Quick flash 1 time for battery level of 1%-25%.

Shifter Lever Operation

When connected to the smartphone with the APP on, push the Shifter Lever up/down to adjust the focal length.

MODE Button

The stabilizer enters Pan Following Mode by default each time when powered on. Switch into Locking Mode by single pressing on the MODE button. Double press the MODE button to enter the Following mode. Single press the MODE button under the Following Mode will return to the previous mode.

Status indicator

- The yellow light is indicator of switching ON/OFF the gimbal. (Switch on: the light quickly flashes for 3s and keeps on for 1s, then goes out; Switch off: the light quickly flashes for 3s and then goes off.)
- The yellow light is charging indicator too. (flashing light shows charging; keeping on shows charging finished.)

How to Power ON/OFF

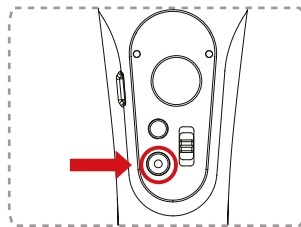

Long press the power button for 3 sec. to power on/off.

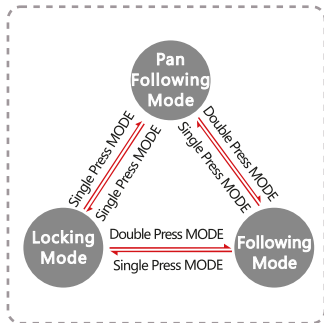

Mode Switch Schematic Figure

Mode switch:

The stabilizer enters Pan Following Mode by default each time when powered on. Switch into Locking Mode by single pressing on the MODE button. Double press the MODE button to enter the Following mode. Single press the MODE button under the Following Mode will return to the previous mode.

See ZHIYUN's product training videos on www.ZHIYUN-TECH.com for more operation tips.

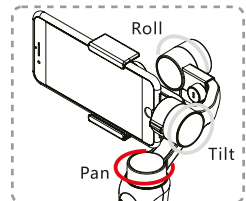

Pan Following Mode:The smartphone pans left/right following the movement of the stabilizer while the tilt and roll axes are locked. Push the joystick up/down allows manual control of the tilt axis.

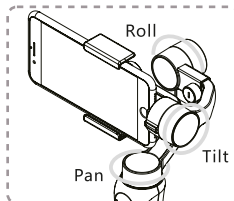

Locking Mode: This mode locks movement of all three axes to keep the camera still and stable. Push the joystick up/down and left/right allows manual control of the tilt axis and pan axis.

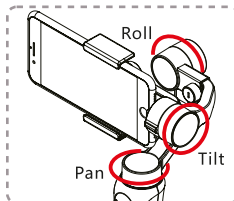

Following Mode: The camera pans and tilts following the movement of the stabilizer. Push the joystick left/right allows manual control of the roll axis.

Micro USB Port

- 1.Connect the stabilizer to your computer using the Micro USB cable for firmware upgrade and on-line calibration.
- 2.Connect the stabilizer to a power source for direct charging. The stabilizer can operate while charging.

Firmware Upgrade

Connect the stabilizer to your computer using the Micro USB cable for firmware upgrade and on-line calibration. Calibration can also be operated through mobile APP.

Visit ZHIYUN's official website: www.ZHIYUN-TECH.com. Click to open the "Downloads" page, and find the Firmware Upgrade Tutorial package. Download the driver, calibration tool and latest firmware corresponding to your stabilizer. Upgrade firmware following the instructions indicated in the Firmware Upgrade Tutorial.

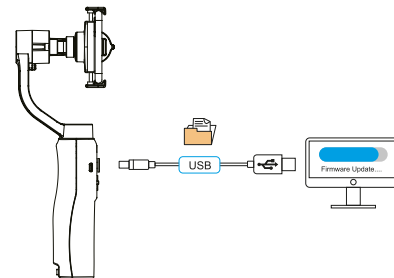

Calibration Method

- 1.Visit ZHIYUN's official website: www.ZHIYUN-TECH.com.
- 2.Click to open the "Downloads" page, and find ZHIYUN' s Gimbal Tools as well as online calibration tutorial; OR
- 3.Operate calibration on mobile APP by connecting to the smartphone.

Connecting the Stabilizer to Smartphone

- 1.Power on the stabilizer.
- 2.Turn on Bluetooth in Settings of your smartphone.
- 3.Tap ZHIYUN's APP icon to open.Tap the signal icon on the top of the APP screen to search for nearby signals, choose your stabilizer to connect.

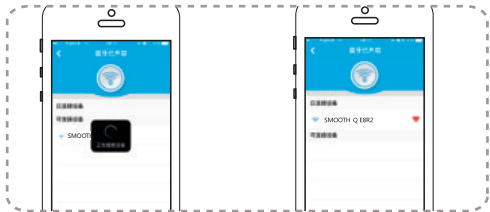

Main Features of the APP



Monitoring screen: Allows checking of the stabilizer's working status and various operation parameters.



Control screen: Functions like the Joystick of SMOOTH-Q and allows various controls to the stabilizer, including change of Gimbal Control Mode and corresponding axis movement control.

Main Features of the APP



Calibration screen: Calibration is required when deviations are found in the 3 axes and the leveling of the camera. Tap "Start Calibration", and complete the 6-side calibration procedure following onscreen illustrations.



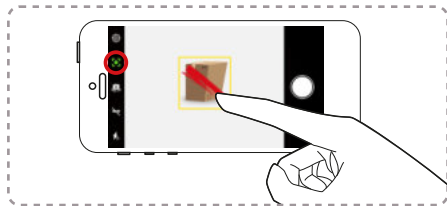

Gimbal setting screen: Allows adjustment of various parameter settings of the stabilizer (Refer to APP instructions for specific operations.)

Smart Object Tracking



Object Tracking:

- 1.Tap to activate  in the APP.
- 2.Tap  icon on the Toolbar to activate Object Tracking.
- 3.Drag to draw a box around the target object with your finger to enable auto tracking.

⚠ This function is available only in Following Mode.

■ NOTICE: All accessories hereunder shall be purchased separately.

ZW-B01 Wireless Remote Control

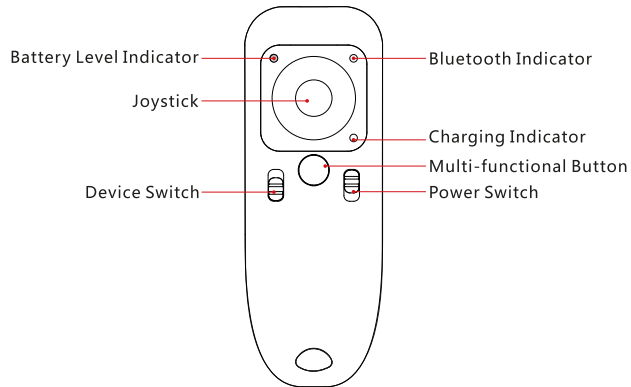

Specifications:

Charging voltage: 5V
 Charging current: 100mA
 Theoretical work time: ≥ 50 hr.
 Built-in Polymer lithium battery capacity: 150mAh
 Emission and received current: 11.9mA
 Operating current: 2.8mA
 Effective control distance: 10M /394 inch (without blockage)

Device Switch

Turn up to connect the stabilizer.
 Turn down to connect the mobile.

Power Switch

Turn up to power on.
 Turn down to power off.

Pairing of Remote Control with the Stabilizer

When using the remote control for the first time, long press the Multi-functional Button while keeping the remote control near the stabilizer, and at the same time turn the Power Switch ON. The Bluetooth Indicator shines solid light when pairing is successful.

Battery Level Indicator

90%-100%: quick flash for 4 times each second.
 75%-90%: quick flash for 3 times each second.
 55%-75%: quick flash for 2 times each second.
 30%-55%: quick flash for 1 time each second.
 0%-30%: quick flashing.

Battery Level Indicator

90%-100%: quick flash for 4 times each second.
 75%-90%: quick flash for 3 times each second.
 55%-75%: quick flash for 2 times each second.
 30%-55%: quick flash for 1 time each second.
 0%-30%: quick flashing.

Multi-functional Button

Single press this button to instruct the stabilizer to return to center position when connected to the stabilizer.

Joystick

For camera movement control and mode switch (operates the same as the joystick of the stabilizer).

Bluetooth Indicator

No connection: Continuous flashing.
 Connected: Shines solid light.
 Device switch: Flashes once.

Charging Indicator

Charging: RED light.
 Charging complete: GREEN light.

ZW-B02 Wireless Remote Control

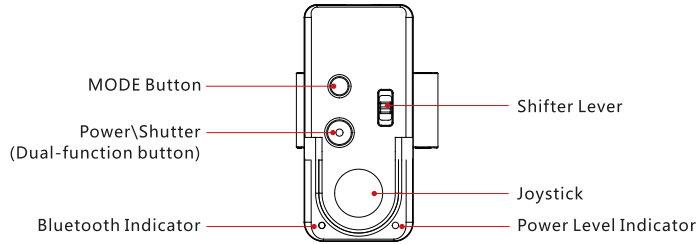

MODE Button: Switches between gimbal control modes (works like the MODE button on the stabilizer).

Power/Shutter (Dual-function button):

Power on/off:

Power on/off the remote controller by pressing the Power button for 1 to 2 sec.

The indicator light will turn on/off accordingly.

NOTICE: Shutter control is not available when used with SMOOTH Q.

Power Button + MODE Button: Press the MODE Button simultaneously when powering up to operate quick pairing with the nearest stabilizer.

Joystick: Controls camera movement (functions the same as the Joystick on Smooth Q).

Shifter Lever: Allows focusing control of the camera.

Specifications:

Charging voltage: 5V

Charging current: 100mA

Theoretical work time: ≥ 30 hr.

Built-in Polymer lithium battery

capacity: 150mAh

Emission and received current: 11.9mA

Operating current: 4.2mA

Effective control distance: 10M /394 inch
(without blockage)

Bluetooth Indicator

No connection: Continuous flashing.

Connected: Shines solid light.

Power Level Indicator

90%-100%: quick flash for 4 times each second.

75%-90%: quick flash for 3 times each second.

55%-75%: quick flash for 2 times each second.

30%-55%: quick flash for 1 time each second.

0%-30%: quick flashing.

Charging Indicator

Charging: RED light.

Charging complete: GREEN light.

💡 The remote controller turns off automatically when left idle for 2 minutes.

Initializing the Stabilizer

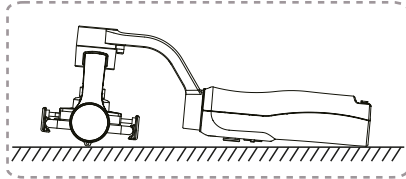

Initializing the Stabilizer

Initialize the stabilizer under the following circumstances:

Slight deviation is found in the tilt angle of the camera in level position after startup.
Slight deviation is found in the roll angle of the camera in level position after startup.
Frequent small angle correction is found when the camera is in level position while the stabilizer stays still.

Initialization Procedure

1. Power on the stabilizer.
2. Long press the MODE button to enter standby mode.
3. Put the stabilizer still on a table surface in random pose, wait for about 10 sec., and the stabilizer will automatically complete initialization.

On-line Calibration

Calibrate the stabilizer when any of the following circumstances occurs:

1. Deviation is found in the balancing of the smartphone even after initialization.
2. The stabilizer has not been used for a long time.
3. The stabilizer is exposed to significant temperature change.

Calibration Method

1. Visit ZHIYUN's official website: www.ZHIYUN-TECH.com.
2. Click to open the "Downloads" page, and find ZHIYUN' s Gimbal Tools as well as online calibration tutorial; OR
3. Operate calibration on mobile APP by connecting to the smartphone.

	Min.	Standard	Max.	Remarks
Input Vol.	6.8V	8.4V	12.6V	
Operation Current	80mA	110mA	1500mA	
Operation Temperature	-10°C		45°C	
Operation Time		12h		Well balanced with camera mounted
Weight		440g		
Tilt Angle Range		320°		
Roll Angle Range		320°		
Pan Angle Range		360°		Unlimited rotation
Compatible Models	Smartphones with sizes under 6.0", GoPro 3/4/5			
Controllable Tilt Angle	-135°		+185°	
Controllable Roll Angle	-30°		+30°	
Controllable Pan Angle		360°		Unlimited rotation
Payload	75g		200g	
Charging Time		2.5h		
Charging Voltage		5V		
Charging Current		1500mA		
Power Output Vol.		5V		
Power Output Current		2000mA		

Warranty Period

1. Customers are entitled to replacement or free repair service in case of quality defect(s) found in the product within 15 days upon receipt of the product.
2. Customers are entitled to free repair service from ZHIYUN for any product proven defective in material or workmanship that results in product failure during normal consumer usage and conditions within the valid warranty period, which is 12 months counting from the date of delivery.

This warranty does not apply to the followings

1. Products subjected to unauthorized repair, misuse, collision, neglect, mishandling, soaking, accident, and unauthorized alteration.
2. Products subjected to improper use or whose labels or security tags have been torn off or altered.
3. Products whose warranty has expired.
4. Products damaged due to force majeure, such as fire, flood, lightning, etc.

Warranty Claim Procedure

1. If failure or any problem occurs to your product after purchase, please contact a local agent for assistant, or you can always contact ZHIYUN's customer service through email at service@zhiyun-tech.com or website at www.zhiyun-tech.com.
2. Your local agent or ZHIYUN's customer service will guide you through the whole service procedure regarding any product issue or problem you have encountered.
3. ZHIYUN reserves the right to reexamine damaged or returned products.

Custom information

Customer Name :

Contact No :

Address :

Sales Manager

Sales Date :

Prod. Serial No :

Dealer :

Contact No :

#1 Maintenance Record

Service Date :

Signature of Repairman :

Cause of Problem :

Service Result : Solved Unsolved Refunded/Replaced



Website



Weibo



Vimeo



Google+



Facebook



Wechat



Youku



Youtube

Tel: +86-773-2320856

Web: www.zhiyun-tech.com

E-mail: service@zhiyun-tech.com

Address: Creative Industrial Park, GuiMo Road, QiXing District, Guilin
541004, Guangxi, China.

Certificate of Quality

This product is confirmed to meet quality standards and permitted for sale after strict inspection.

QC Inspector: _____



Please download the latest version from www.zhiyun-tech.com

This document is subject to change.

ZHIYUN™ is a trademark of ZHIYUN.

Copyright©2017 ZHIYUN. All rights reserved.