

HSP 2 HSP 4

Bedienungsanleitung
Instructions for use
Notice d'emploi
Istruzioni per l'uso
Instrucciones de uso
Gebruiksaanwijzing

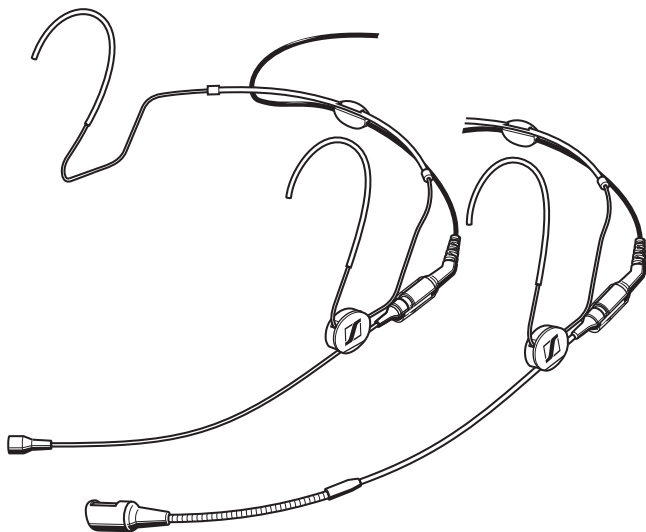

Contents

Safety instructions	2
Delivery includes	3
HSP 2/HSP 4.....	4
Putting the HSP 2 into operation	5
Attaching the microphone to the left or right side	5
Adjusting the microphone boom and the neckband	7
Windshields for the HSP 2	9
Treble boost using the frequency response caps	10
HSP 2 cable variants	11
Putting the HSP 4 into operation	12
Attaching the microphone to the left or right side	12
Adjusting the microphone boom and the neckband	14
Attaching the sound inlet basket	15
Attaching the cable to the cable grip	16
HSP 4 cable variants	17
Care and maintenance	18
Accessories/spare parts	21
Specifications.....	23
Specifications HSP 2/HSP 2-M	23
Specifications HSP 4/HSP 4-M	25
Manufacturer Declarations	27

Thank you for choosing Sennheiser!

We have designed this product to give you reliable operation over many years. Over 60 years of accumulated expertise in the design and manufacture of high-quality electro-acoustic equipment have made Sennheiser a world-leading company in this field. Please take a few moments to read these instructions carefully, as we want you to enjoy your new Sennheiser products quickly and to the fullest.

Safety instructions

- Please read these instructions carefully and completely before using the device.
- Make these instructions easily accessible to all users at all times.
- Always include these instructions when passing the device on to third parties.
- Water entering the housing of the device can cause a short-circuit and damage the electronics. Protect the device from wetness. Use only a slightly damp cloth to clean the device.
- Do not expose the device to extreme temperatures (normal operating temperatures: 10 °C to 35 °C).
- Use the device with care and store it in a clean, dust-free environment.

Intended use of the device

Intended use includes:

- having read these instructions, especially the chapter “Safety instructions”,
- using the device within the operating conditions and limitations described in this instruction manual.
- never opening the device. If devices are opened by customers in breach of this instruction, the warranty becomes null and void.

“Improper use” means using the device other than as described in these instructions, or under operating conditions which differ from those described herein.

Delivery includes

Delivery of the HSP 2/HSP 4 includes:

- 1 boom microphone
- 1 neckband
- 5 clips
- 1 silicone tube
- 1 connection cable
- 1 plastic transport case, foam-lined with cut-outs
- 1 windshield (HSP 4 only)
- 2 caps, short and long (HSP 2 only)
- 1 instruction manual
- 1 Warranty Certificate

HSP 2/HSP 4

HSP 2 and HSP 4 are high-quality condenser headmics designed for professional “hands free” applications. Their adjustable neckband is visually unobtrusive and very comfortable to wear. The 24 available HSP variants differ in size, color and connector (see “HSP 2 cable variants” on page 11 and “HSP 4 cable variants” on page 17).

There are two pick-up patterns available:

- HSP 2: omni-directional
- HSP 4: cardioid

Features

- Individually adjustable to all head sizes
- Neckband design keeps the microphone clear from shirt-collar or clothing
- Thin microphone boom, interchangeable
- Microphone boom can be attached to the left or right side (clip)
- Adjustable neckband for optimum adaption of the angle
- Microphone boom is adjustable in length
- All metal parts of the neckband and the microphone boom are coated in a physical vapour deposition process (scratch-resistant)
- Modular overall system, i.e. all system components are easily interchangeable

Putting the HSP 2 into operation

The HSP 2 is ready for operation on delivery. The microphone can be worn on the left or right side of the mouth. If you do **not** want to change sides, continue on page 7.

Attaching the microphone to the left or right side



The neckband has as a clip which is designed so that the microphone boom can be worn on either side of the mouth.

CAUTION! Damage to the microphone boom!



The microphone boom can break or be impaired in its function when you bend or turn it in the wrong place.

- ▶ Only adjust the microphone boom as described in this chapter.

To remove the microphone boom:

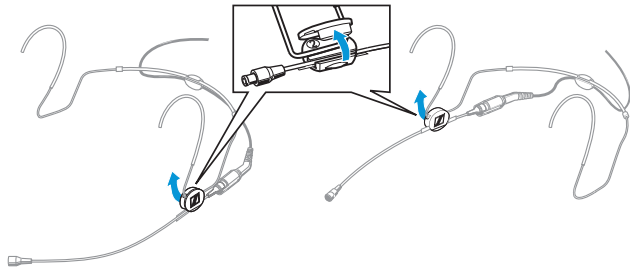

- ▶ Open the clip on the neckband.
- ▶ Carefully remove the microphone boom and the neckband from the clip.

To reattach the microphone boom:

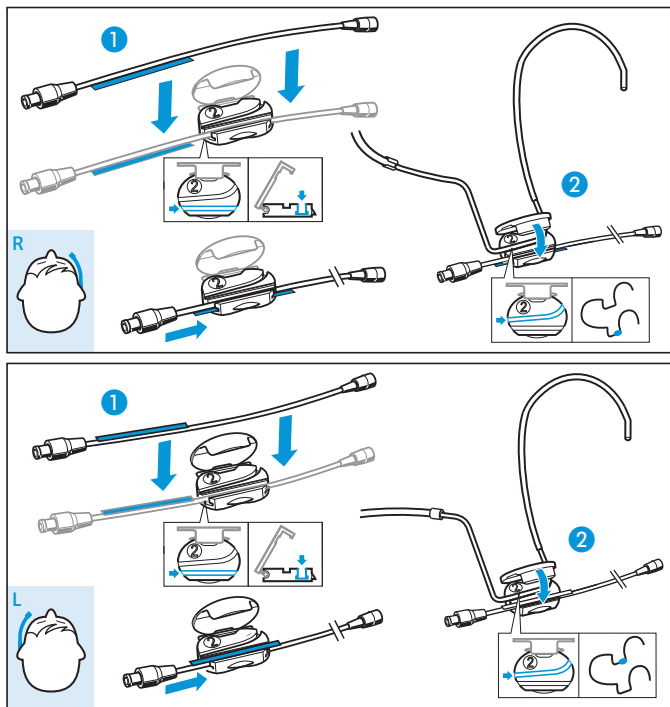

- ▶ **1** First press the microphone boom and then the neckband into the clip as shown.
- ▶ **2** Close the clip.

Adjusting the microphone boom and the neckband

For best possible comfort and optimum fit of the headmic, the neckband and the microphone boom have to be adjusted to properly fit your head.

CAUTION! Damage to the microphone boom!



The microphone boom can break or be impaired in its function when you bend or turn it in the wrong place.

- ▶ For adjusting the microphone boom, **ONLY** bend or turn the neckband.

Positioning the microphone towards the corner of the mouth

To individually position the microphone:

- ▶ Bend the neckband ① at the clip to adjust the angle of the microphone boom ②.
- ▶ Push the microphone boom ② backwards or forwards in the clip so that the microphone is positioned at the corner of the mouth as shown.

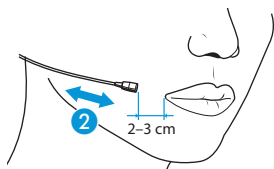
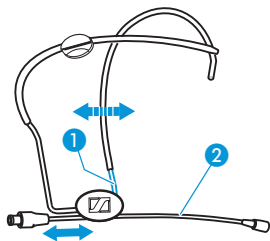

Adjusting the neckband

The neckband is flexible and ensures an optimum fit.

- ▶ Change the length of the neckband until a snug but comfortable fit is achieved.
- ▶ If necessary, adjust the neckband at the earhooks.

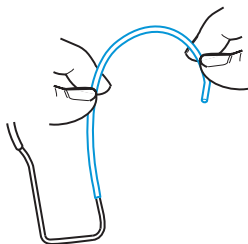
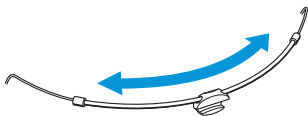

Attaching the cable to the cable grip

- ▶ Attach the microphone cable to the cable grip in the centre of the neckband.

Note:

When attaching the thin cable, make sure you also press the small cable sleeve into the cable grip or the cable will fall out.

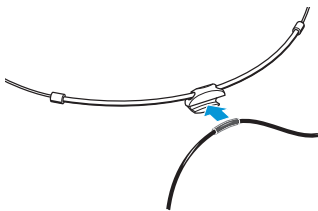

Windshields for the HSP 2

The quality of outdoor recordings and close miking can be impaired by wind noise. An effective attenuation of wind noise can be obtained by using the MZW 2 and the MZW 02 windshields.

To begin with, use the MZW 2 windshield ③ which reduces wind noise by a maximum of 20 dB.

With the additional MZW 02 foam windshield ④ you can reduce wind noise by a further 10 dB.

The MZW 2 and MZW 02 are available as accessories.

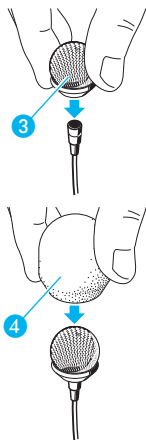

Treble boost using the frequency response caps

Your HSP 2 headmic is supplied with two different frequency response caps. These caps allow you to adjust the microphone's sensitivity in the presence area (see "Frequency response curve HSP 2" on page 24):

- Short cap: MZC 2-1 (treble boost of 2 dB)
- Long cap: MZC 2-2 (treble boost of 4 dB)

Use these caps if the microphone cannot be positioned close to the mouth. The further away the microphone is from the mouth, the less treble is picked up. In addition, you should use these caps if the sound is too muffled or if you want to increase the speech intelligibility.

- ▶ Slip the cap of your choice onto the microphone until it engages with the second notch.

HSP 2 cable variants

The headmics are available in two sizes. The -M variants have smaller neckbands and shorter microphone booms.

Connection cable with 3-pin lockable special connector

Suitable for Sennheiser SK 50, SK 250, SK 5012 and SK 3063 bodypack transmitters.

HSP 2	anthracite	Cat. No. 009862
HSP 2-3	beige	Cat. No. 009863
HSP 2-M	anthracite	Cat. No. 500694
HSP 2-3-M	beige	Cat. No. 500690

Steel wire cable with 3.5 mm mini-jack

Suitable for SK 100, SK 300 and SK 500 evolution wireless series bodypack transmitters. For wired applications, the headmic can be used with the intelligent MZA 900 P phantom power adapter.

HSP 2-ew	anthracite	Cat. No. 009866
HSP 2-ew-3	beige	Cat. No. 009872
HSP 2-ew-M	anthracite	Cat. No. 500693
HSP 2-ew-3-M	beige	Cat. No. 500692

Steel wire cable with open ends

HSP 2-5	anthracite	Cat. No. 009868
HSP 2-5-3	beige	Cat. No. 009869
HSP 2-5-M	anthracite	Cat. No. 500691
HSP 2-3-5-M	beige	Cat. No. 500689

Putting the HSP 4 into operation

The HSP 4 is ready for operation on delivery. The microphone can be worn on the left or right side of the mouth. If you do **not** want to change sides, continue on page 14.

Attaching the microphone to the left or right side



The neckband has as a clip which is designed so that the microphone boom can be worn on either side of the mouth.

CAUTION! Damage to the microphone boom!



The microphone boom can break or be impaired in its function when you bend or turn it.

- ▶ Only adjust the microphone boom as described in this chapter.

To remove the microphone boom:

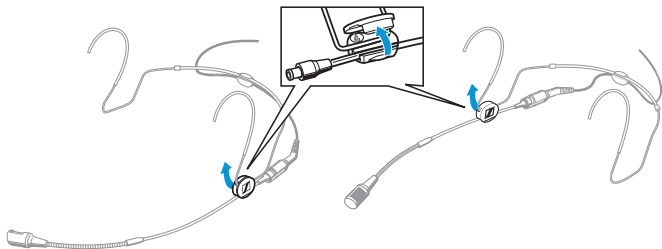

- ▶ Open the clip on the neckband.
- ▶ Carefully remove the microphone boom and the neckband from the clip.

To reattach the microphone boom:

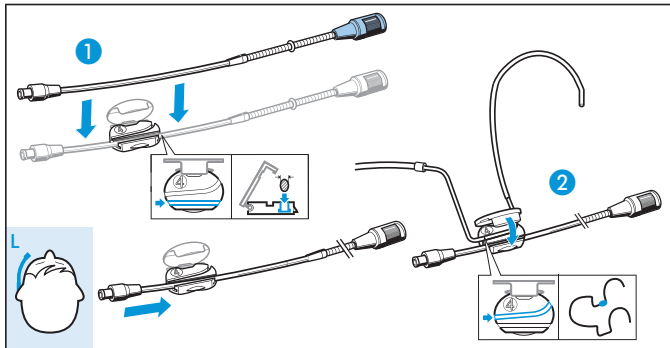
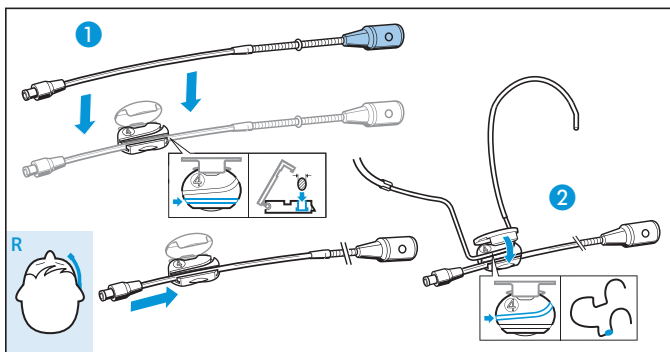

- ▶ **1** First press the microphone boom and then the neckband into the clip as shown.
- ▶ **2** Close the clip.

Adjusting the microphone boom and the neckband

For best possible comfort and optimum fit of the headmic, the neckband and the microphone boom have to be adjusted to properly fit your head.

CAUTION! Damage to the microphone boom!



The microphone boom can break or be impaired in its function when you bend or turn it.

- ▶ For adjusting the microphone boom, **ONLY** bend or turn the neckband or the flexible gooseneck at the **forward** part of the microphone boom.

Positioning the microphone towards the corner of the mouth

To individually position the microphone:

- ▶ Bend the neckband **1** at the clip to adjust the angle of the microphone boom **2**.
- ▶ Push the microphone boom **2** backwards or forwards in the clip so that the microphone is positioned directly at the corner of the mouth as shown.
- ▶ If necessary, precisely position the microphone by using the flexible gooseneck **3**.

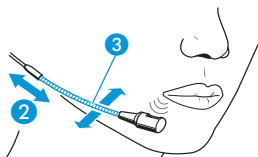
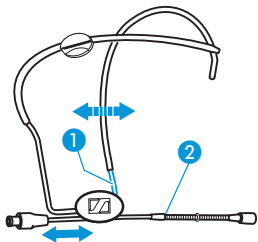

Attaching the sound inlet basket

Notes:

- Do not position the microphone directly in front of your mouth as it will pick up your breathing and plosive noises from your mouth. In addition, moisture can adversely affect the sound and performance of your microphone.
- When attaching the sound inlet basket, make sure that it locks into place with an audible click.
- Make sure not to cover the sound inlet.

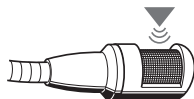

Adjusting the neckband

The neckband is flexible and ensures an optimum fit.

- ▶ Change the length of the neckband until a snug but comfortable fit is achieved.
- ▶ If necessary, adjust the neckband at the earhooks.

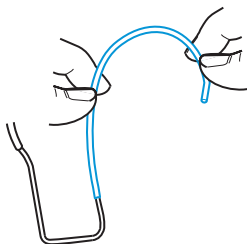
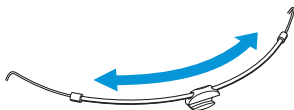

Attaching the cable to the cable grip

- ▶ Attach the microphone cable to the cable grip in the centre of the neckband.

Note:

When attaching the thin cable, make sure you also press the small cable sleeve into the cable grip or the cable will fall out.

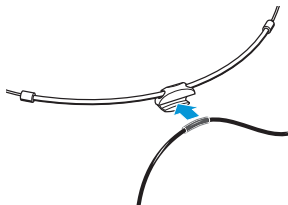

HSP 4 cable variants

The headmics are available in two sizes. The -M variants have smaller neckbands and shorter microphone booms.

Connection cable with 3-pin lockable special connector

Suitable for Sennheiser SK 50, SK 250, SK 5012 and SK 3063 bodypack transmitters.

HSP 4	anthracite	Cat. No. 009864
HSP 4-3	beige	Cat. No. 009865
HSP 4-M	anthracite	Cat. No. 500700
HSP 4-3-M	beige	Cat. No. 500696

Steel wire cable with 3.5 mm mini-jack

Suitable for SK 100, SK 300 and SK 500 evolution wireless series bodypack transmitters. For wired applications, the headmic can be used with the intelligent MZA 900 P phantom power adapter.

HSP 4-ew	anthracite	Cat. No. 009867
HSP 4-ew-3	beige	Cat. No. 009873
HSP 4-ew-M	anthracite	Cat. No. 500699
HSP 4-ew-3-M	beige	Cat. No. 500698

Steel wire cable with open ends

HSP 4-5	anthracite	Cat. No. 009870
HSP 4-5-3	beige	Cat. No. 009871
HSP 4-5-M	anthracite	Cat. No. 500697
HSP 4-3-5-M	beige	Cat. No. 500695

Care and maintenance

CAUTION! Liquids can damage the electronics of the device!
Liquids entering the housing of the device can cause a short-circuit and damage the electronics.



- ▶ Only use a soft, slightly damp cloth to clean the device.

Cleaning the sound inlet basket (HSP 4 only)

- ▶ To clean or replace the sound inlet basket, carefully pull it from the capsule.
- ▶ Moisten a small brush (bristle brush or toothbrush) with isopropyl alcohol.
- ▶ Carefully brush off the sound inlet basket.
- ▶ Allow the sound inlet basket to air dry for approx. 1 hour so that the remaining isopropyl alcohol can evaporate.
- ▶ Reattach the sound inlet basket to the capsule so that it locks into place with an audible click. When attaching the sound inlet basket, make sure not to cover the sound inlet.

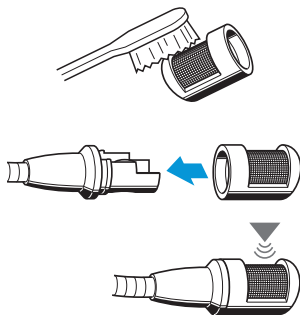

Cleaning the contacts of the connection cable

Over time, salt deposits from sweat can build up on the connector and the socket. Clean the connector and the socket using standard isopropyl alcohol.

To loosen the connection:

- ▶ Slide the silicone tube aside.
- ▶ Insert your fingernail into the join.
- ▶ Pull the connector and the socket apart as shown.

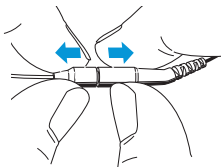
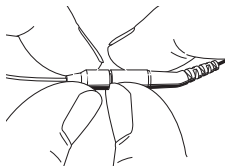
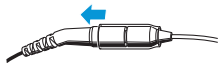

- ▶ Moisten a small brush (bristle brush or toothbrush) with isopropyl alcohol.
- ▶ Carefully brush off the connector and the socket and remove the salt deposits.
- ▶ Rinse the connector and the socket with isopropyl alcohol to remove the remaining salt deposits.

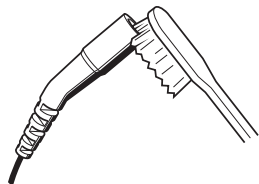

- ▶ Dry the connector and the socket using a soft cloth or a small piece of cotton wool and carefully tap them off.
- ▶ Allow the connector and the socket to air dry for approx. 1 hour so that the remaining isopropyl alcohol can evaporate.
- ▶ Slide the silicone tube onto the connector.
- ▶ Connect the connector to the socket.

Accessories/spare parts

The following accessories and/or spare parts are available for the HSP 2 / HSP 4:

Spare parts for HSP 2

Parts	Cat. No.
Boom microphone, omni-directional, beige	511711
Boom microphone, omni-directional, anthracite	511712
HSP-M boom microphone, omni-directional, anthracite	515280
HSP-M boom microphone, omni-directional, beige	515281
MZC 2-1 cap, short, anthracite	085842
MZC 2-2 cap, long, anthracite	085839
MZC 2-1 cap, short, beige	085843
MZC 2-2 cap, long, beige	085840
MZ 2 make-up protector	004743
MZW 2 windshield, black	047185
MZW 2 windshield, beige	047186
MZW 02 foam windshield, anthracite	076615
Set of clips for HSP 2, beige	528165
Set of clips for HSP 2, black	528166

Spare parts for HSP 4

Parts	Cat. No.
Boom microphone, cardioid, beige	511713
Boom microphone, cardioid, anthracite	511714

HSP-M boom microphone, cardioid, anthracite	515282
HSP-M boom microphone, cardioid, beige	515283
Windshield cap, cardioid, anthracite	511715
Windshield cap, cardioid, beige	511716
MZW 4 foam windshield, black	510862
MZW 4 foam windshield, beige	510863
Set of clips for HSP 4, beige	528167
Set of clips for HSP 4, black	528168

Spare parts for HSP 2 and HSP 4

Parts

Cat. No.

Neckband, anthracite	511709
Neckband, beige	511710
HSP-M neckband, anthracite	515278
HSP-M neckband, beige	515279
Cable with 3-pin lockable special connector, black	511717
Cable with 3-pin lockable special connector, beige	511718
Steel wire cable with 3.5 mm mini-jack, black	511719
Steel wire cable with 3.5 mm mini-jack, beige	511720
Steel wire cable with open ends, black	511721
Steel wire cable with open ends, beige	511722
Plastic transport case	511723
MZA 900 P phantom power adapter	500226

Specifications

Specifications HSP 2/HSP 2-M

Frequency response	20–20,000 Hz \pm 3 dB
Pick-up pattern	omni-directional
Nominal impedance (at 1 kHz)	1 k Ω
Min. terminating impedance	4.7 k Ω
Sensitivity	2 mV/Pa \pm 3 dB
Diameter of mic capsule	4.8 mm
Max. sound pressure level	150 dB
Equivalent noise level	28 dB (A)
Supply current	approx. 250 μ A
Power supply	4.5 – 15 V
Operating temperature	–10 °C to +50 °C
Cable length	1.6 m
Diameter of boom arm	1.1 mm
Weight HSP 2/HSP 2-M	2.1 g/2.0 g
Connector	see “HSP 2 cable variants” on page 11

Neckband

Width HSP 2/HSP 2-M	110 mm/80 mm
Weight HSP 2/HSP 2-M	4.4 g/4.0 g

Polar diagram HSP 2

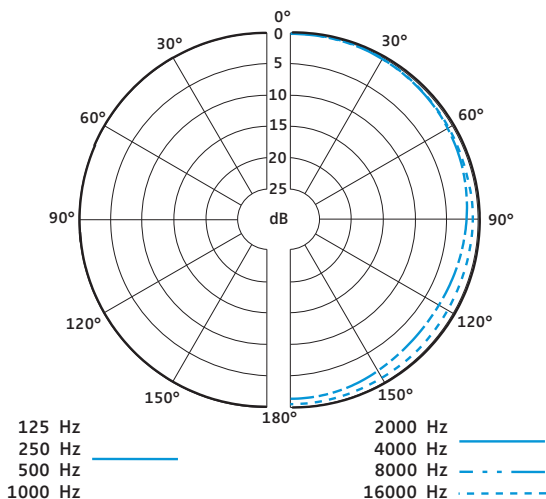

Frequency response curve HSP 2

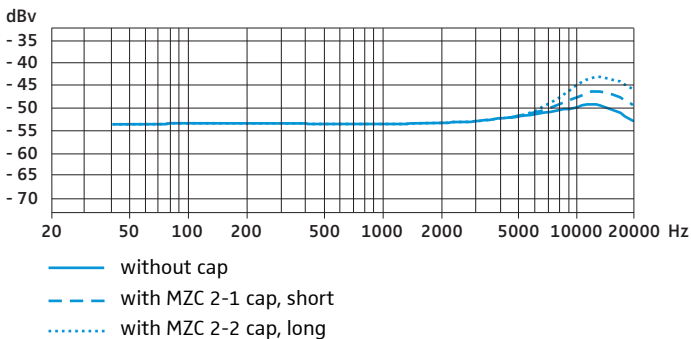

Specifications HSP 4/HSP 4-M

Frequency response	40–20,000 Hz ± 3 dB
Pick-up pattern	cardioid
Nominal impedance (at 1 kHz)	1 k Ω
Min. terminating impedance	4.7 k Ω
Sensitivity	4 mV/Pa ± 3 dB
Diameter of mic capsule	8.4 mm
Max. sound pressure level	150 dB
Equivalent noise level	37 dB (A)
Supply current	approx. 250 μ A
Power supply	4.5 – 15 V
Operating temperature	–10 °C to +50 °C
Cable length	1.6 m
Diameter of boom arm	2.0 mm
Weight HSP 4/HSP 4-M	4.8 g/4.0 g
Connector	see “HSP 4 cable variants” on page 17

Neckband

Width HSP 4/HSP 4-M	110 mm/80 mm
Weight HSP 4/HSP 4-M	4.4 g/4.0 g

Polar diagram HSP 4

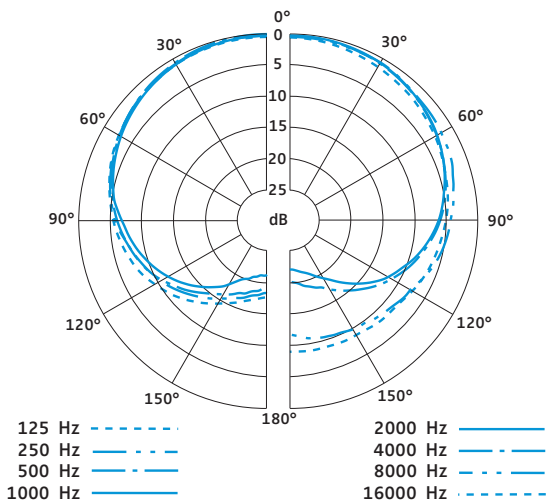

Frequency response curve HSP 4

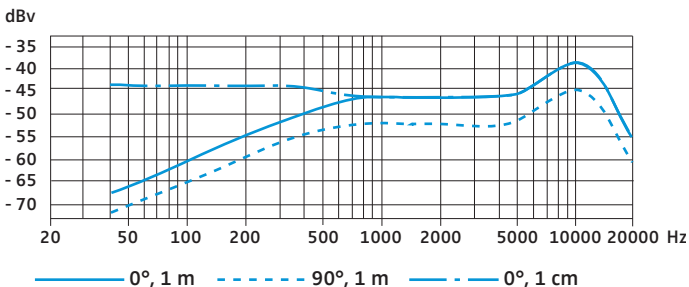

Manufacturer Declarations

Warranty

2 years

CE Declaration of Conformity



This equipment is in compliance with the essential requirements and other relevant provisions of Directive 2004/108/EC. The declaration is available on the Internet at www.sennheiser.com.

WEEE Declaration



Please dispose of this product at the end of its operational lifetime by taking it to your local collection point or recycling center for such equipment.



Sennheiser electronic GmbH & Co. KG
Am Labor 1, 30900 Wedemark, Germany
Phone +49 (5130) 600 0
Fax +49 (5130) 600 300
www.sennheiser.com

Printed in Germany
Publ.01/08
527045/A01