

SK 2000



Instruction manual

Contents

Important safety instructions	2
The SK 2000 bodypack transmitter	3
Areas of application	3
The frequency bank system	4
Delivery includes	5
Product overview	6
Overview of the SK 2000 bodypack transmitter	6
Overview of the displays	7
Putting the bodypack transmitter into operation	8
Inserting the batteries/accupack	8
Charging the accupack	8
Connecting the microphone cable/instrument cable	9
Attaching the bodypack transmitter to clothing	10
Using the bodypack transmitter	11
Switching the bodypack transmitter on/off	11
Deactivating the lock mode temporarily	12
Muting the audio signal or deactivating the RF signal	13
Selecting a standard display	15
Using the operating menu	16
The buttons	16
Overview of the operating menu	16
Working with the operating menu	18
Synchronizing the bodypack transmitter with a receiver	20
Synchronizing the bodypack transmitter with the receiver – individual operation	20
Synchronizing bodypack transmitters with receivers – multi-channel operation	20
Cleaning the bodypack transmitter	21
If a problem occurs	21
Specifications	23



For further information, visit the SK 2000 product page on our website at www.sennheiser.com.

Important safety instructions

- Read this instruction manual.
- Keep this instruction manual. Always include this instruction manual when passing the product on to third parties.
- Heed all warnings and follow all instructions.
- Use only a cloth for cleaning the product.
- Do not place the product near any heat sources such as radiators, stoves, or other devices (including amplifiers) that produce heat.
- Only use attachments/accessories specified by Sennheiser.
- Refer all servicing to qualified service personnel.
Servicing is required if the product has been damaged in any way, liquid has been spilled, objects have fallen inside, the product has been exposed to rain or moisture, does not operate properly or has been dropped.
- **WARNING:** To reduce the risk of short circuits, do not use the product near water and do not expose it to rain or moisture.

Intended use

Intended use of the SK 2000 bodypack transmitter includes:

- having read this instruction manual, especially the chapter “Important safety instructions”,
- using the product within the operating conditions and limitations described in this instruction manual.

“Improper use” means using the product other than as described in these instructions, or under operating conditions which differ from those described herein.

The SK 2000 bodypack transmitter

This bodypack transmitter is part of the 2000 series. With this series, Sennheiser offers high-quality state-of-the-art RF transmission systems with a high level of operational reliability and ease of use. Transmitters and receivers permit wireless transmission with studio-quality sound.



Features of the 2000 series:

- Optimized PLL synthesizer and microprocessor technology
- HDX noise reduction system
- Pilot tone squelch control
- True diversity technology
- Switching bandwidth of up to 75 MHz
- Increased immunity to intermodulation and interferences in multi-channel operation

Areas of application

The bodypack transmitter can be combined with the EM 2000 or EM 2050 rack-mount receiver. The receivers are available in the same UHF frequency ranges and are equipped with the same frequency bank system with factory-preset frequencies. An advantage of the factory-preset frequencies is that:

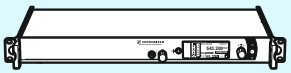
- a transmission system is ready for immediate use after switch-on,
- several transmission systems can be operated simultaneously on the preset frequencies without causing intermodulation interference.

Transmitter	Optional accessories	Receivers
SK 2000 	<ul style="list-style-type: none"> • Clip-on microphones: MKE 1, ME 102, ME 104, ME 105* • Headmics: HSP 2, HSP 4* • Instrument cable: CI 1-4* 	EM 2000 receiver  EM 2050 twin receiver 

* each fitted with a 3-pin special audio connector

Overview of the microphones and instrument cables:

Microphone/instrument cable	Type	Pick-up pattern
MKE 1 clip-on microphone	condenser	○ omni-directional
ME 102 clip-on microphone		○ cardioid
ME 104 clip-on microphone		☞ cardioid
ME 105 clip-on microphone		☞ super-cardioid
HSP 2 headmic		○ omni-directional
HSP 4 headmic		☞ cardioid
CI 1-4 instrument cable	–	–

The frequency bank system

The bodypack transmitter is available in 6 UHF frequency ranges with up to 3,000 transmission frequencies per frequency range:

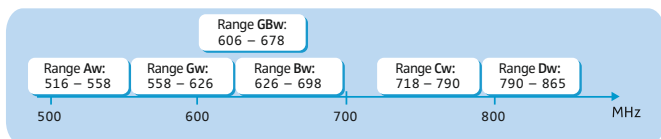

Each frequency range (Aw–Ew, Gw, GBw) offers 26 frequency banks with up to 64 channels each:

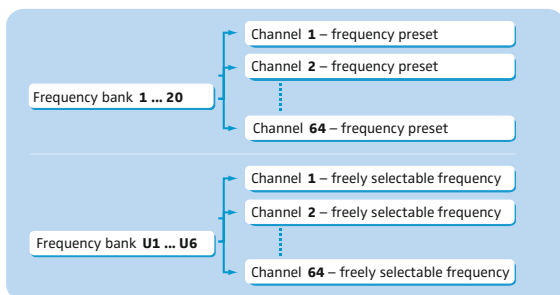

Each of the channels in the frequency banks "1" to "20" has been factory-preset to a fixed frequency (frequency preset). The factory-preset frequencies within one frequency bank are intermodulation-free. These frequencies cannot be changed.

For an overview of the frequency presets, please refer to the supplied frequency information sheet. Updated versions of the frequency information sheet can be downloaded from the corresponding product page on our website at www.sennheiser.com.

The frequency banks "U1" to "U6" allow you to freely select and store transmission frequencies. It might be that these transmission frequencies are **not** intermodulation-free.

Delivery includes

The packaging contains the following items:

- 1 SK 2000 bodypack transmitter
- 2 AA size batteries, 1.5 V
- 1 instruction manual
- 1 frequency information sheet
- 1 supplement "Framework requirements and restrictions on the use of radio microphones"

Product overview

Overview of the SK 2000 bodypack transmitter

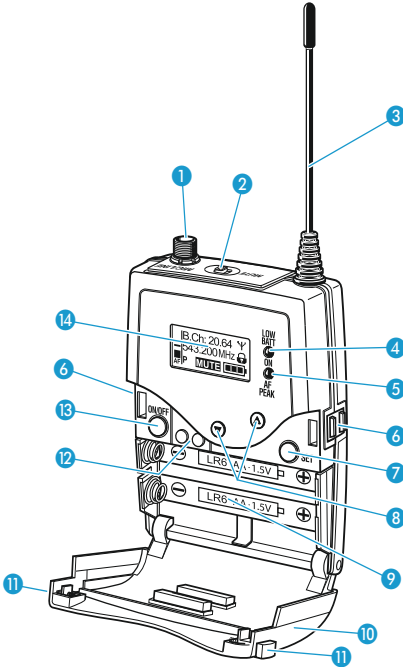



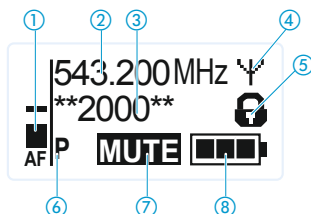

- 1 Microphone/instrument input (MIC/LINE), 3-pole special audio socket, lockable
- 2 MUTE switch
- 3 Antenna
- 4 Operation and battery status indicator, red LED:
lit = ON
flashing = LOW BATT
- 5 Audio overmodulation indicator, yellow LED:
lit = AF PEAK
- 6 Charging contacts
- 7 SET button
- 8 UP/DOWN button ▲/▼
- 9 Battery compartment
- 10 Battery compartment cover (metal)
- 11 Battery compartment catches
- 12 Infra-red interface
- 13 ON/OFF button (serves as the ESC (cancel) key in the operating menu)
- 14 Display panel, backlit in orange

Overview of the displays

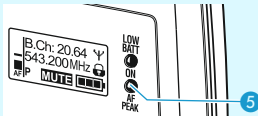
After switch-on, the bodypack transmitter displays the standard display “Frequency/Name”. For further illustrations and examples of the different standard displays, refer to page 15. The display backlighting is automatically reduced after approx. 20 seconds.

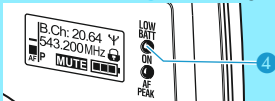

Display	Meaning
① Audio level “AF”	<p>Modulation of the bodypack transmitter</p> <p>When the audio input level is excessively high, the “AF” display shows full deflection and, in addition, the yellow AF PEAK LED ⑤ lights up:</p> 
② Frequency	Current transmission frequency
③ Name	Freely selectable name of the transmitter
④ Transmission icon	RF signal is being transmitted
⑤ Lock mode icon	Lock mode is activated
⑥ “P” (pilot tone)	Pilot tone transmission is activated
⑦ “MUTE”	Microphone or line input is muted
⑧ Battery status	<p>Charge status:</p> <ul style="list-style-type: none">  approx. 100%  approx. 70%  approx. 30% <p>charge status is critical, the red LOW BATT LED ④ is flashing:</p> 

Putting the bodypack transmitter into operation

Inserting the batteries/accupack

For powering the bodypack transmitter, you can either use two 1.5 V AA size batteries or the rechargeable Sennheiser BA 2015 accupack or the DC 2 power adapter (accessories, visit www.sennheiser.com).

- ▶ Open the battery compartment by pushing the two catches **11** in the direction of the arrows and open the cover **10**.

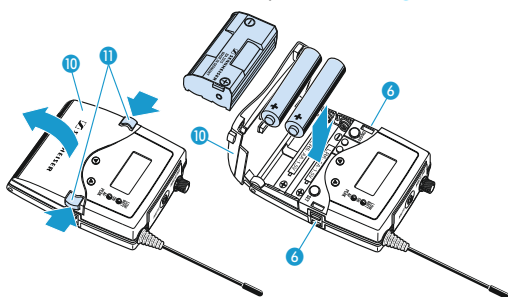

- ▶ Insert the two batteries or the accupack as shown above. Please observe correct polarity when inserting the batteries/accupack.
- ▶ Close the battery compartment.
The battery compartment cover **10** locks into place with an audible click.

Charging the accupack

To charge the BA 2015 accupack (accessory, visit www.sennheiser.com) installed in the bodypack transmitter:

- ▶ Insert the bodypack transmitter into the L 2015 charger (accessory, visit www.sennheiser.com).



The L 2015 charger can only charge the combination BA 2015 accupack/bodypack transmitter. Standard batteries (primary cells) or individual rechargeable battery cells cannot be charged.

Connecting the microphone cable/instrument cable

The audio input is designed for the connection of both condenser microphones and instruments (e.g. guitars). DC powering of the condenser microphones is via the **MIC/LINE** socket **1** (3-pole special audio socket).

- ▶ Use one of the recommended Sennheiser microphones or the CI 1-4 instrument cable (see page 3).
- ▶ Connect the 3-pin special audio connector **15** from the Sennheiser microphone or instrument cable to the **MIC/LINE** socket **1**.

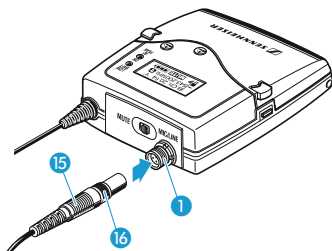

- ▶ Lock the 3-pin special audio connector by screwing down the coupling ring **16**.
- ▶ Via the operating menu ("Sensitivity" menu item), adjust the sensitivity of the microphone/line input.

Attaching the bodypack transmitter to clothing

You can use bodypack pouch or the belt clip 18 to attach the bodypack transmitter to clothing (e.g. belt, waistband).

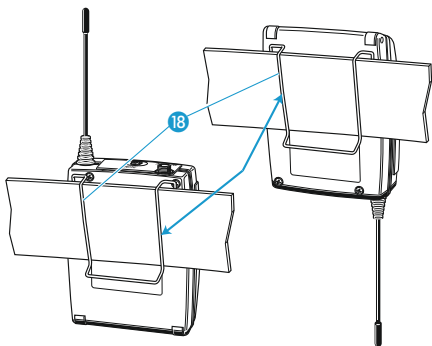

The belt clip is detachable so that you can also attach the transmitter with the antenna pointing downwards. To do so, withdraw the belt clip 18 from its fixing points and attach it the other way round.

The belt clip 18 is secured so that it cannot slide out of its fixing points accidentally.

To detach the belt clip:

- ▶ Lift one side of the belt clip as shown.

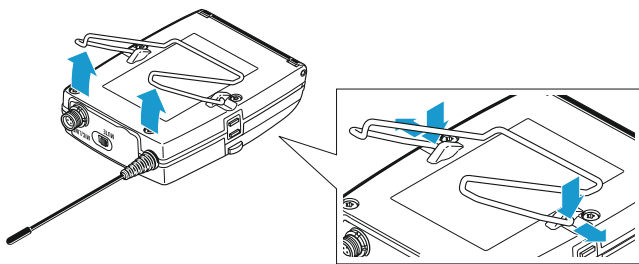

- ▶ Press down the belt clip at one fixing point and pull it out of the transmitter housing.
- ▶ Repeat for the other side.

Using the bodypack transmitter

To establish a transmission link, proceed as follows:

1. Switch the bodypack transmitter on (see next section).
2. Switch the receiver on (see the instruction manual of the receiver).
The transmission link is established and the display backlighting of the receiver changes from red to orange.



It is vital to observe the notes on frequency selection on page 20.

If you cannot establish a transmission link between transmitter and receiver, read the chapter "Synchronizing the bodypack transmitter with a receiver" on page 20.

Switching the bodypack transmitter on/off

- ▶ Push the two battery compartment catches **11** and open the battery compartment cover **10**.

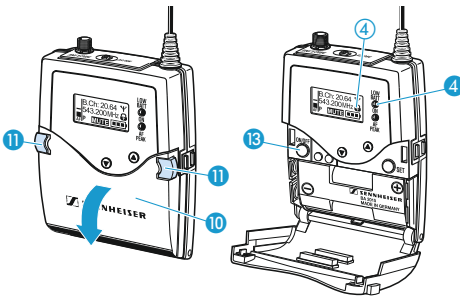

To switch the bodypack transmitter **on** (online operation):

- ▶ Briefly press the **ON/OFF** button **13**.
The "**Frequency/Name**" standard display appears on the display panel. The red **ON LED** **4** lights up and the transmission icon **4** is displayed. The bodypack transmitter transmits an RF signal.

To switch the bodypack transmitter **on** and to **deactivate the RF signal on switch-on** (offline operation):

- ▶ Keep the **ON/OFF** button **13** pressed until "**RF Mute Off?**" appears on the display panel.

Using the bodypack transmitter

- ▶ Press the UP/DOWN button ▲/▼.
"RF Mute On?" appears on the display panel.
- ▶ Press the SET button.
The transmission frequency is displayed but the bodypack transmitter does not transmit an RF signal. The transmission icon ④ is not displayed. When the pilot tone function is activated on both bodypack transmitter and receiver, "RF Mute" (backlit in red) appears alternately with the standard display on the receiver's display panel.



Use this function to save battery power or to prepare a bodypack transmitter for use during live operation without causing interference to existing transmission links.

To activate the RF signal:

- ▶ Press the ON/OFF button.
"RF Mute On?" appears on the display panel.
- ▶ Press the UP/DOWN button ▲/▼.
"RF Mute Off?" appears on the display panel.
- ▶ Press the SET button.
The RF signal is activated and the transmission icon ④ is displayed again.

To switch the bodypack transmitter off:

- ▶ If necessary, deactivate the lock mode (see next chapter).
- ▶ Keep the ON/OFF button ⑬ pressed until "OFF" appears on the display panel. The red ON LED ④ goes off and the display panel turns off.



When in the operating menu, pressing the ON/OFF button ⑬ will cancel your entry (ESC function) and return you to the current standard display.

Deactivating the lock mode temporarily

You can activate or deactivate the automatic lock mode via the "Auto Lock" menu item. If the lock mode is activated, you have to temporarily deactivate it in order to be able to operate the bodypack transmitter:



- ▶ Press the **SET** button or the **ON/OFF** button.
"Locked" appears on the display panel.



- ▶ Press the **UP/DOWN** button **▲/▼**.
"Unlock?" appears on the display panel.



- ▶ Press the **SET** button.
The lock mode is temporarily deactivated.
 - When you are in the operating menu, the lock mode remains deactivated until you exit the operating menu.
 - When one of the standard displays is shown, the lock mode is automatically activated after 10 seconds.

The lock mode icon **5** flashes prior to the lock mode being activated again.

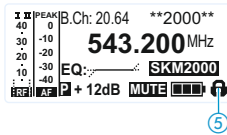

Muting the audio signal or deactivating the RF signal

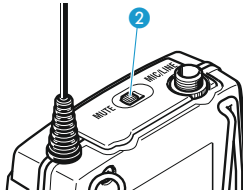

The **MUTE** switch **2** allows you to mute the audio signal or to deactivate the RF signal. Via the "Mute Mode" menu item, you can set the desired function of the **MUTE** switch **2**.

Setting	Slide the MUTE switch 2 ...	Function
"AF On/Off"	... to the left (position MUTE)	Mutes the audio signal
	... to the right	Unmutes the audio signal
"RF On/Off"	... to the left (position MUTE)	Deactivates the RF signal (offline operation)
	... to the right	Activates the RF signal (online operation)
"Disabled"	No function	

- ▶ From the "Mute Mode" menu item, select the desired setting.
- ▶ Exit the operating menu.
- ▶ Slide the **MUTE** switch **2** to the left, to the position **MUTE**.
The bodypack transmitter reacts as indicated in the table.

Using the bodypack transmitter

The current state of the muting function or the RF signal is displayed on the display panel of the bodypack transmitter.



An additional display of the muting function appears on the receiver's display panel when

- the pilot tone function is activated on both bodypack transmitter and receiver
and, in addition,
- this display has been activated via the “Warnings” menu item on the receiver (see the instruction manual of the receiver).

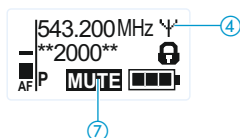

Audio signal is muted

Transmitter's display panel: “MUTE” ⑦ is displayed

Receiver's display panel: “TX Mute” is displayed*

* only when activated on the receiver (see above)

Audio signal is activated (muting is deactivated)

Transmitter's display panel: “MUTE” ⑦ is not displayed

Receiver's display panel: “TX Mute” is not displayed

RF signal is deactivated

Transmitter's display panel: Transmission icon ④ is not displayed, “MUTE” ⑦ is displayed

Receiver's display panel: “RF Mute” is displayed*

* only when activated on the receiver (see above)

RF signal is activated

Transmitter's display panel: Transmission icon ④ is displayed

Receiver's display panel: “RF Mute” is not displayed



You can also deactivate the RF signal on switch-on. For more information, refer to the chapter “Switching the bodypack transmitter on/off” on page 11.

Using the **ON/OFF** button, you can also activate/deactivate the RF signal during operation. To do so, briefly press the **ON/OFF** button and proceed as described on page 12.



Selecting a standard display

- ▼ ▲ ▶ Press the UP/DOWN button ▲/▼ to select a standard display:

Contents of the display	Selectable standard display
	“Frequency/Name”
	“Channel/Frequency”
	“Name/Channel”

Using the operating menu

The buttons

Button	Function of the button
Press the ON/OFF button 	<ul style="list-style-type: none"> Switches the bodypack transmitter on and off Cancels the entry and returns to the current standard display (ESC function) Activates/deactivates the RF signal (special function, see page 13)
Press the SET button 	<ul style="list-style-type: none"> Changes from the current standard display to the operating menu Calls up a menu item Enters a submenu Stores the settings and returns to the operating menu
Press the UP/DOWN button ▲/▼ 	<ul style="list-style-type: none"> Selects a standard display Changes to the next/previous menu item Changes the setting of a menu item

Overview of the operating menu

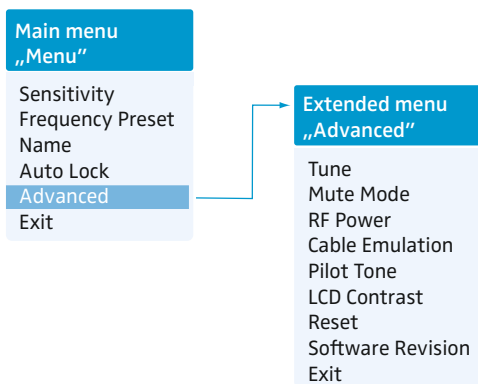

Display	Function of the menu item
---------	---------------------------

Main menu "Menu"

Sensitivity	Adjusts the sensitivity "AF"
Frequency Preset	Sets the frequency bank and the channel
Name	Enters a freely selectable name
Auto Lock	Activates/deactivates the automatic lock mode
Advanced	Calls up the extended menu "Advanced Menu"
Exit	Exits the operating menu and returns to the current standard display

Extended menu "Advanced Menu"

Tune	Sets the transmission frequencies for the frequency banks "U1" to "U6"
	Sets the channel and the transmission frequency for the frequency banks "U1" to "U6"
Mute Mode	Sets the mode for the MUTE switch ②
RF Power	Adjusts the transmission power
Cable Emulation	Emulates guitar cable capacities
Pilot Tone	Activates/deactivates the pilot tone transmission
LCD Contrast	Adjusts the contrast of the display panel
Reset	Resets the settings made in the operating menu
Software Revision	Displays the current software revision
Exit	Exits the extended menu "Advanced Menu" and returns to the main menu

Working with the operating menu





If the lock mode is activated, you have to deactivate it in order to be able to work with the operating menu (see page 12).

By way of example of the “Sensitivity” menu, this section describes how to use the operating menu.

Changing from a standard display to the operating menu

-  Press the **SET** button.
The current standard display is replaced by the main menu.
The last called up menu item is displayed.



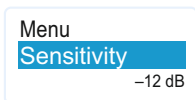

Selecting a menu item

-  Press the UP/DOWN button /  to change to the “Sensitivity” menu item.
The current setting of the selected menu item is displayed:

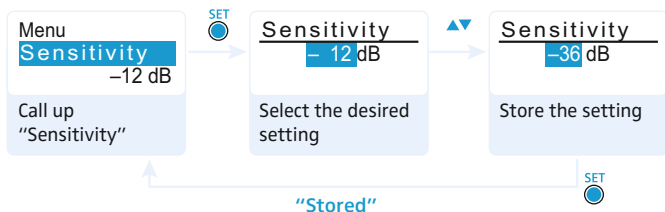

Changing and storing settings



-  Press the **SET** button to call up the menu item.
-  Press the UP/DOWN button /  to adjust the input sensitivity.
-  Press the **SET** button to store the setting.

Canceling an entry

- ON/OFF** ▶ Press the **ON/OFF** button to cancel the entry.
 The current standard display appears on the display panel.

To subsequently return to the last edited menu item:

- SET** ▶ Press the **SET** button repeatedly until the last edited menu item appears.

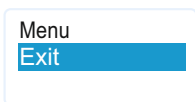

Exiting a menu item

- ▼ ▲** ▶ Change to the “Exit” menu item.



- SET** ▶ Confirm your selection.
 You return to the next higher menu level or you exit the operating menu and return to the current standard display.

To directly return to the current standard display:

- ON/OFF** ▶ Press the **ON/OFF** button.

Synchronizing the bodypack transmitter with a receiver

When synchronizing the bodypack transmitter with a receiver, please observe the following:



- ▶ Only use a transmitter and a receiver from the same frequency range (see the type plates on the transmitter and the receiver).
- ▶ Make sure that the desired frequencies are listed in the enclosed frequency information sheet.
- ▶ Make sure that the desired frequencies are approved and legal in your country and, if necessary, apply for an operating license.

Synchronizing the bodypack transmitter with the receiver – individual operation

Upon delivery, the bodypack transmitter and the receiver are synchronized with each other. However, if you cannot establish a transmission link between bodypack transmitter and receiver, you have to synchronize the channels of the devices.

For information on automatic synchronization of the bodypack transmitter with the receiver (individual operation), refer to the instruction manual of the receiver. This information is marked with the **syn** icon.

Alternatively, you can set the channel on the bodypack transmitter manually:

- ▶ Make sure that you set the bodypack transmitter to the same frequency bank and the same channel as the receiver.

If you still cannot establish a transmission link, refer to the chapter “If a problem occurs ...” on page 21.

Synchronizing bodypack transmitters with receivers – multi-channel operation

Combined with 2000 series receivers, 2000 series bodypack transmitters can form transmission links that can be used in multi-channel systems.

For information on automatic synchronization of bodypack transmitters with receivers (multi-channel operation), refer to the instruction manual of your receiver.

For more information on multi-channel operation, visit the SK 2000 product at www.sennheiser.com.

Cleaning the bodypack transmitter

CAUTION! Liquids can damage the electronics of the bodypack transmitter!

Liquids entering the housing of the device can cause a short-circuit and damage the electronics.

▶ Keep all liquids away from the bodypack transmitter.

▶ Use a cloth to clean the bodypack transmitter from time to time.

If a problem occurs ...

Problem	Possible cause	Possible solution
Bodypack transmitter cannot be operated, "Locked" appears on the display panel	Lock mode is activated	Deactivate the lock mode (see page 12).
No operation indication	Batteries are flat or accupack is flat	Replace the batteries or recharge the accupack (see page 8).
No RF signal at the receiver	Bodypack transmitter and receiver are not on the same channel	Set the bodypack transmitter to the same channel as the receiver. Synchronize the bodypack transmitter with the receiver (see page 20).
	Bodypack transmitter is out of range	Reduce the distance between bodypack transmitter and receiving antenna. Increase the transmission power ("RF Power" menu item).
	RF signal is deactivated ("RF Mute")	Activate the RF signal (see page 13).

Problem	Possible cause	Possible solution
RF signal available, no audio signal, "MUTE" appears on the display panel	Bodypack transmitter is muted (MUTE)	Cancel the muting (see page 13).
	Receiver's squelch threshold is adjusted too high	Reduce the squelch threshold setting on the receiver.
	Bodypack transmitter doesn't transmit a pilot tone	Activate or deactivate the pilot tone transmission ("Pilot Tone" menu item).
Audio signal has a high level of background noise or is distorted	Bodypack transmitter's sensitivity is adjusted too low/too high	Adjust the input sensitivity ("Sensitivity" menu item).

If a problem occurs that is not listed in the above table or if the problem cannot be solved with the proposed solutions, please contact your local Sennheiser partner for assistance.

To find a Sennheiser partner in your country, search at www.sennheiser.com under "Service & Support".

Specifications

RF characteristics

Modulation	wideband FM
Frequency ranges	516–558, 558–626, 626–698, 718–790, 790–865, 606–678 MHz (Aw to Dw, Gw, GBw, see page 4)
Transmission frequencies	up to 3,000 frequencies, tuneable in steps of 25 kHz 20 frequency banks, each with up to 64 factory-preset channels 6 frequency banks, each with up to 64 user programmable channels
Switching bandwidth	up to 75 MHz
Nominal/peak deviation	± 24 kHz/ ± 48 kHz
Frequency stability	$\leq \pm 15$ ppm
RF output power at 50 Ω	switchable: typ. 10 mW (Low) typ. 30 mW (Standard) typ. 50 mW (High)
Pilot tone squelch	can be switched off

AF characteristics

Compander system	Sennheiser HDX
AF frequency response	microphone: 80–18,000 Hz line: 25–18,000 Hz
Signal-to-noise ratio (1 mV, peak deviation)	≥ 120 dBA
THD	≤ 0.9 %
Max. input voltage (microphone/line)	3 V_{rms}
Input impedance	microphone: 40 k Ω , unbalanced line: 1 M Ω
Adjustment range of input sensitivity	60 dB, adjustable in 3-dB steps

Specifications

Overall device

Temperature range	- 10°C to + 55°C
Power supply	2 AA size batteries, 1.5 V or BA 2015 accupack
Nominal voltage	2.4 V ---
Power consumption:	
• at nominal voltage	typ. 185 mA (30 mW)
• with switched-off transmitter	$\leq 25 \mu\text{A}$
Operating time	typ. 8 hrs
Dimensions	approx. 82 mm x 64 mm x 24 mm
Weight (incl. batteries)	approx. 160 g

In compliance with

Europe:



EMC	EN 301489-1/-9
Radio	EN 300422-1/-2
Safety	EN 60065 EN 62311 (SAR)

Approved by

Canada:

Industry Canada RSS-123
IC: 2099A-SK2000
limited to 698 MHz

USA:

FCC-Part 74
FCC-ID: DMOSK2000
limited to 698 MHz

Connector assignment

3-pin special audio connector

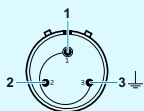

- Pin 1: AF and 5.2 V AB-powering; 8.2 k Ω internal resistance, optimized for Sennheiser pre-polarized condenser microphones
- Pin 2: +5.2 V for guitar or ground
- Pin 3 and thread: ground



Sennheiser electronic GmbH & Co. KG

Am Labor 1, 30900 Wedemark, Germany
www.sennheiser.com

Publ. 12/16, 549128