

VIDEO DEVICES



PIX-E5 / PIX-E5H

Recording Field Monitors

User Guide

Legal Notices

Product specifications and features are subject to change without prior notification.

**Copyright © 2016
Sound Devices, LLC
All rights reserved**

This product is subject to the terms and conditions of a software license agreement provided with the product, and may be used in accordance with the license agreement.

This document is protected under copyright law. An authorized licensee of this product may reproduce this publication for the licensee's own personal use. This document may not be reproduced or distributed, in whole or in part, for commercial purposes, such as selling copies or providing educational services or support.

This document is supplied as a technical guide. Special care has been taken in preparing the information for publication; however, since product specifications are subject to change, this document might contain omissions and technical or typographical inaccuracies. Sound Devices, LLC does not accept responsibility for any losses due to the use of this guide.

Trademarks

The "wave" logo and USBPre are registered trademarks, and FileSafe, PowerSafe, and PIX-Assist are trademarks of Sound Devices, LLC.

Mac and OS X are trademarks of Apple Inc., registered in the U.S. and other countries. Windows is a registered trademark of Microsoft Corporation in the United States and other countries. Gorilla is a registered trademark of Corning Incorporated.

Manual Conventions

Symbol	Description
>	This symbol is used to show the order in which you select menu commands and sub-options, such as: System > Version Info indicates you use the Control knob to navigate the Main menu and select System followed by Version Info.
+	A plus sign is used to show button or keystroke combinations. For instance, ALT+MENU means to hold the ALT button down as you press the MENU button. Ctrl+V means to hold the Control key down and press the V key simultaneously.
ⓘ	A note provides recommendations and important related information. The text for notes also appear italicized in a different color.
⚠	A cautionary warning about a specific action that could cause harm to you, the device, or cause you to lose data. Follow the guidelines in this document or on the unit itself when handling electrical equipment. The text for cautionary notes also appear bold and italicized in a different color.

PIX-E5/PIX-E5H User Guide • Rev 3-C • Oct. 21, 2016

This document is distributed by Sound Devices, LLC in PDF format only. E-published in the USA.

www.sounddevices.com

support@sounddevices.com

Sound Devices, LLC
E7556 Road 23 and 33
Reedsburg, Wisconsin USA

+1 (608) 524-0625
Toll Free: (800) 505-0625
Fax: +1 (608) 524-0655

Revision History

This table provides the revision history of this guide.

Rev#	Date	Firmware Version	Description
1-A	Jul 2015	v1.00	Initial Official Publication for PIX-E5 launch
1-B	Aug 2015	v1.01/1.02	Updates that addressed 4K speckling and added one feature: <ul style="list-style-type: none"> File deletion - See "Deleting Recorded Files" in the Storage chapter.
1-C	Aug 2015	v1.03/1.04	Updates for PIX-E5H product launch & feature enhancements: <ul style="list-style-type: none"> HDMI Record Triggers - See "Setting up a Record Trigger" in the Recording and Playback chapter. Increased channels for HDMI I/O - See "Setting up Audio Input" and "Routing Audio Output" in the Audio chapter QuickBoot Timer - See note in table located in "Top and Front Panels" in Overview of Chassis chapter. File List HH:MM:SS Duration - See "Playing Back Recorded Files" in Recording and Playback chapter.
1-D	Sep 2015	v1.05	Update with feature enhancements: <ul style="list-style-type: none"> LUTs - See "Using LUTs" in the PIX-Assist Monitoring chapter. Custom LUTs - See "Uploading Custom LUTs" in the PIX-Assist Monitoring chapter. HDMI Record Triggers for Panasonic - See "Setting up a Record Trigger" in the Recording and Playback chapter.
1-E	Dec 2015	v1.10/1.20	Update with feature enhancements: <ul style="list-style-type: none"> Timecode via HDMI and 3.5 mm line inputs - See "Setting a Timecode Mode" in the Timecode chapter. LUTs to SDI Out - See "Enabling LUTs on SDI Output" in the PIX-Assist Monitoring chapter. Anamorphic Desqueeze - See "Using Anamorphic Desqueeze" in the PIX-Assist Monitoring chapter. Fast forward and Rewind - See "Using Fast Forward and Rewind" in the Recording and Playback chapter. Jogging and Shuttling - See "Jogging and Shuttling" in the Recording and Playback chapter. 3:2 Pulldown - See "Using 3:2 Pulldown Removal" in the Recording and Playback chapter. Initial Official Publication for PIX-E7 launch
1-F	Feb 2016	v1.30	Update with feature enhancements: <ul style="list-style-type: none"> Expanded anamorphic desqueeze menu options - See "Using Anamorphic Desqueeze" in the PIX-Assist Monitoring chapter. New LCD Orientation menu - See "Adjusting LCD Orientation" in the Menus and Navigation chapter. Improved False Color menu - See "Using False Colors" in the Monitoring chapter. New System sub-menu for screen saver - See "Configuring the Screen Saver" in the System Functions chapter. New shortcut button combination for screenshots - See "Capturing the Screen Display" in the Shortcuts chapter. Updated Specs: TC via SDI Out. See "Timecode" in the Specs chapter. Timecode menu revised - See the Timecode chapter.
2-A	Mar 2016	v2.00	Initial Official Publication for PIX-LR launch: See the new PIX-LR Audio Interface chapter.

Rev#	Date	Firmware Version	Description
3-A	May 2016	v3.00	<p>Update with feature enhancements:</p> <ul style="list-style-type: none"> • H.264 recording & dual-codec record - See "Selecting a Video Codec" and "Enabling Dual-Codec Recording" in the Recording & Playback chapter. • New SD Card File List screen. See "Viewing the File List" in the Recording & Playback chapter.
3-B	July 2016	v3.00	<ul style="list-style-type: none"> • Minor edits to guide, unrelated to firmware release
3-C	Oct 2016	v3.50	<p>Update with feature enhancements:</p> <ul style="list-style-type: none"> • Ability to add/delete cue markers during record or playback - See "Setting Cue Markers" in the Recording & Playback chapter. See also "Record Soft Keys" and "USB Keyboard" in the Menus and Navigation chapter. • New Playback modes - See "Setting the Playback Mode" in the Recording & Playback chapter. • Ability to create a play list - See "Using the Play List" in the Recording & Playback chapter. • Ability to loop playback of file or play list - See "Looping Playback" in the Recording & Playback chapter.

Table of Contents

Overview of the Chassis

7

Top and Front Panels	7
Left Side Panel	9

Back and Bottom Panels	10
Right Side Panel	11

Menus and Navigation

13

Touch Screen and Tactile Controls	13
Accessing the MAIN MENU Screen	13
Toggling On-Screen Display Elements	14
Toggling Soft Key Button Functionality	15
Monitor Soft Keys	16

Record Soft Keys	16
Using Soft Key Menus	17
Configuring the On-Screen Display	19
Adjusting LCD Orientation	19
USB Keyboard	21

PIX-Assist Monitoring Suite

23

Overview	23
Assist Tools	24
Using False Colors	24
Using Zebras	27
Using Zoom	28
Using Peaking	30
Scopes	32
Using the Waveform Monitor	32
Using the Vectorscope	34

Using the Histogram	35
Using 4-Way Monitoring	36
Using LUTs	37
Enabling LUTs on SDI Output	39
Using Custom LUTs	39
Using Anamorphic Desqueeze	40
Using Markers	44
Resetting Monitor Defaults	46

Storage

47

SpeedDrive	47
SD Memory Card	48
Metadata and File Name Format	49
File Name Formats	50
Formatting Storage Drives	50

Working with Files	50
Deleting Recorded Files	52
Transferring Files from SpeedDrive	52
Transferring Files from SD Card	53

Recording and Playback

55

Overview	55
Record and Playback Icons	56
Recording	56
Choosing a Video Input Source	57
Setting up a Record Trigger	57
Video Codecs: ProRes and H.264	58
Understanding Recording/Drive Error Messages	60
Setting PsF Options	60
Using 3:2 Pulldown Removal	61

FileSafe	61
Viewing the File Lists	62
Setting Cue Markers	64
Playing Back Recorded Files	64
Setting the Playback Mode	65
Using Fast Forward and Rewind	66
Jogging and Shuttling	67
Looping Playback	68
Using the Play List	68

Audio

71

Using the Audio Screen	71
Setting up Audio Input	72
Setting up Tracks	73

Routing Audio Output	73
Adjusting Headphone Warning Bell Level	74

Timecode

75

Setting a Timecode Mode	75
Toggling Drop Frame Timecode	76

Setting the Rec Run Timecode Value	76
--	----

System Functions

79

Fan	79	Updating Firmware	81
Time and Date	80	Checking Version and Serial Number	82
Setting the Date and Time	80	Saving and Recalling Settings	82
Configuring the Screen Saver	81	Restoring Factory Default Settings	83

Helpful Shortcuts

85

Viewing the HELP Screen	85	Capturing the Screen Display	87
Shortcuts	86		

Specifications

89

PIX-E5 Specifications	89	PIX-E5H Specifications	92
Video	89	Video	92
Audio	90	Audio	93
Storage	91	Storage	93
Timecode	91	Timecode	93
Power	91	Power	94
Physical	91	Physical	94
Environmental	92	Environmental	94

PIX-LR Audio Interface

95

Front Panel	95	Adjusting Gain with the PIX-LR	100
Top Panel	96	Choosing a Headphone Source	102
Back Panel	97	Adjusting PIX-LR LED Brightness	103
Assigning Audio Input Sources to XLR	97	Specifications	103
Modifying Audio Settings	98	Declaration of Conformity	104
Audio Screen Differences with PIX-LR	100		



Overview of the Chassis

The PIX-E5 and PIX-E5H are specifically designed and built for the rigors of field production.

The chassis is made of high-strength, thermally conductive aluminum. As well as providing maximum durability, the case doubles as a heat-sink, providing excellent cooling of the inner electronics.

By design, the PIX-E chassis gets very warm, wicking away the heat from the internal components. This design ensures that the internal components stay cool for years of trouble-free operation in the most demanding environments.

Topics in this section include:

- ▶ **Top and Front Panels**
- ▶ **Left Side Panel**
- ▶ **Back and Bottom Panels**
- ▶ **Right Side Panel**

Top and Front Panels

The top panel features the Power switch, a Power LED, a ¼-inch, 20-threaded mounting point, and two retainer clips used to secure batteries and the Speed-Drive to the back of the monitor.

The front panel has a sunlight-readable, 5-inch LCD that is protected behind an alkali-aluminosilicate sheet of Gorilla® Glass 2, chemically strengthened to be scratch- and impact-resistant.

Beneath the LCD is a row of buttons, which includes an ALT button on the left, a MENU button on the right, and in between them, 11 multi-functional soft key buttons.

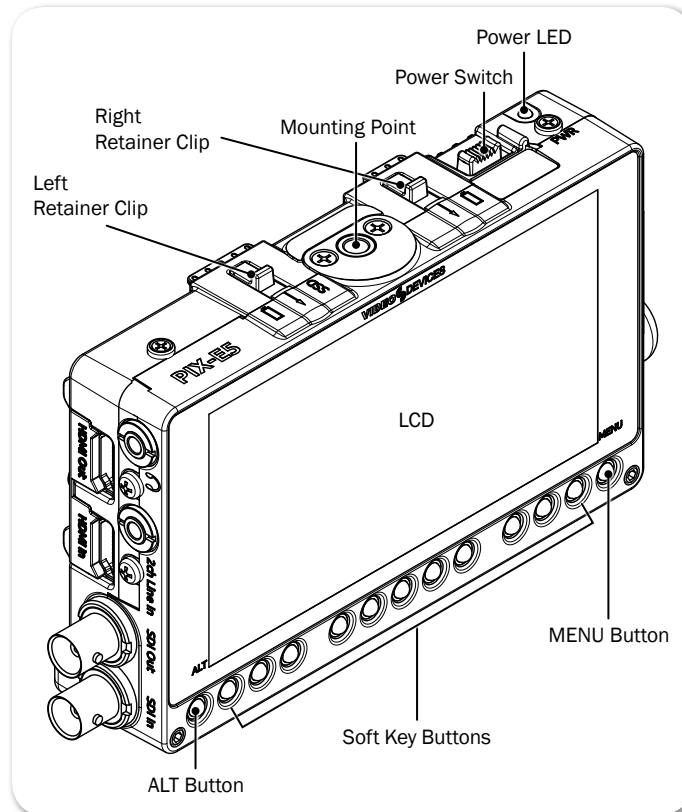

FEATURE	DESCRIPTION
Power Switch & LED	Slide the Power switch to the right to turn on the device. While power is on, the LED will illuminate green. When power is first turned on, a splash screen with the Video Devices logo will appear on the LCD.
<p>① <i>PIX-E monitors have a very powerful processor and operating system, so it takes up to 45 seconds to boot the first time. However, the QuickBoot™ feature reduces subsequent boot times to just a few seconds. QuickBoot is enabled for two hours after powering down the monitor. Each time the monitor is turned off, this timer is reset. During this time, boot times are reduced, but after two hours, QuickBoot is deactivated and powering on the monitor will result in a normal, longer boot process.</i></p>	
Retainer Clips	<p>The retainer clips snap into place to securely hold batteries and/or the SpeedDrive™ to the back of the monitor. The right clip, labeled with a battery icon, secures the right L-mount battery; the left clip, labeled SSD, holds both the SpeedDrive and the left L-mount battery.</p> <p>Depress the spring-loaded retainer clips toward the front of the monitor to release the drive and batteries.</p>
Mounting Point	Centered on the top and bottom panels, a ¼-inch, 20 threaded, stainless-steel mounting point may be used to attach the monitor to a camera or other production gear, such as the PIX-ARM.
LCD	5-inch LCD touch screen. 1920x1080 pixel resolution. Displays the user interface, source video, and playback video, as well as operating information when the on-screen display is active.
ALT Button	Toggles alternative functions for the Soft Key buttons. It may be used in combination with the Control knob to reset a setting to its default. It may also be used to exit various screens and return to the live video screen.
MENU Button	Displays the Main menu. May also be used to exit various screens.

FEATURE	DESCRIPTION
Soft Key Buttons	Multi-functional buttons. Each soft key button's function is displayed as a label on the LCD directly above the button.

Left Side Panel

The left side of the PIX-E5 provides various I/O ports for audio and video. The PIX-E5H is an HDMI only unit, so it does not have SDI ports.

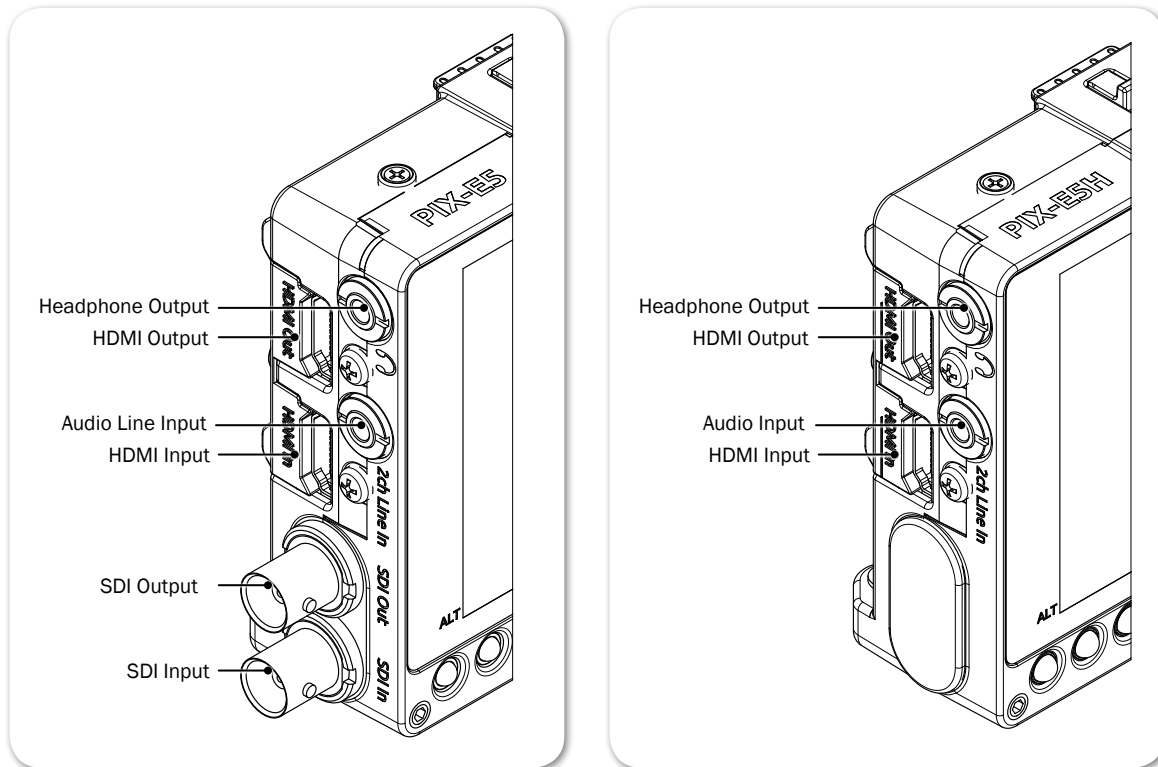

FEATURE	DESCRIPTION
Headphone Output	1/8-inch (3.5mm) unbalanced stereo headphone output.
HDMI Output	Outputs HDMI video with up to eight channels of embedded audio.
Audio Line Input	1/8-inch (3.5mm) unbalanced, line-level, 2-channel input.
HDMI Input	Accepts HDMI (1.4a) signal with four channels of embedded audio. <i>ⓘ The monitor does not record or display content encoded with HDCP copy protection.</i>
SDI Output*	Outputs up to 8 channels of embedded audio.
SDI Input*	Accepts up to 8 channels of embedded audio.

* Applies to PIX-E5 only

Back and Bottom Panels

The back panel features two battery mounts and a USB connector for mounting a SpeedDrive. The bottom panels offers a ¼-inch, 20-threaded mounting point to secure the monitor to cameras and other devices.

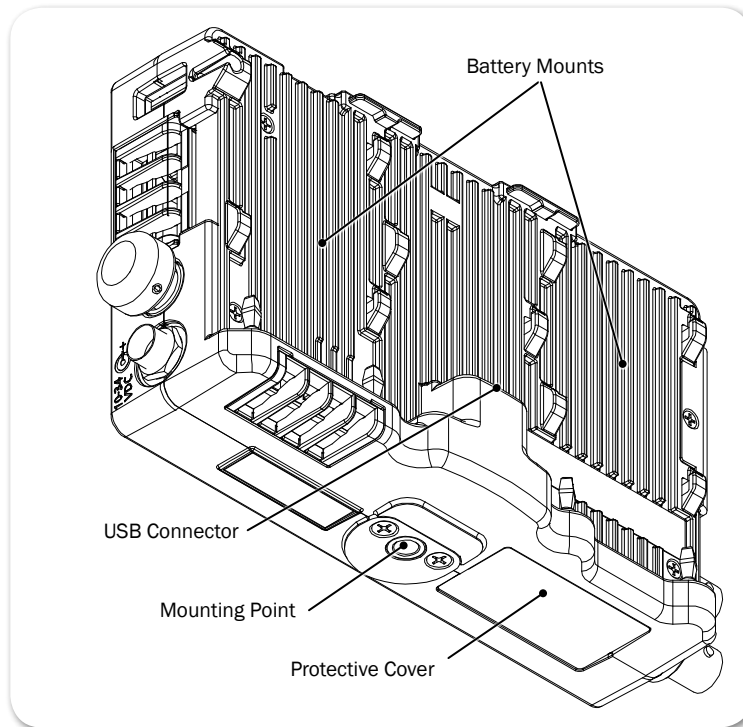

FEATURE	DESCRIPTION
Battery Mounts	Located on the left and right side of the back panel are two mounts for Sony® L-Series Lithium-ion batteries, or third-party batteries compatible with the mount.
USB Connector	Centered between the battery mounts on the back panel is the USB connector for a SpeedDrive with installed mSATA drive. <i>ⓘ The USB connector cannot be used with any USB-based drive.</i>
Mounting Point	Centered on the top and bottom panels, a ¼-inch, 20 threaded, stainless-steel mounting point may be used to attach the monitor to a camera or other production gear, such as the PIX-ARM.
Protective Cover	This removable cover is attached with adhesive to the monitor’s bottom panel and protects the connection used for integration with the optional PIX-LR accessory.

⚠ Caution regarding battery usage: There is danger of explosion if the battery is incorrectly replaced. Replace only with the same or equivalent type. Properly recycle batteries. Do not crush, disassemble, incinerate, dispose in a fire or expose batteries to high temperatures.

Right Side Panel

The right panel features a SD card slot, a Control knob, and ports for connecting external power or a peripheral USB keyboard.

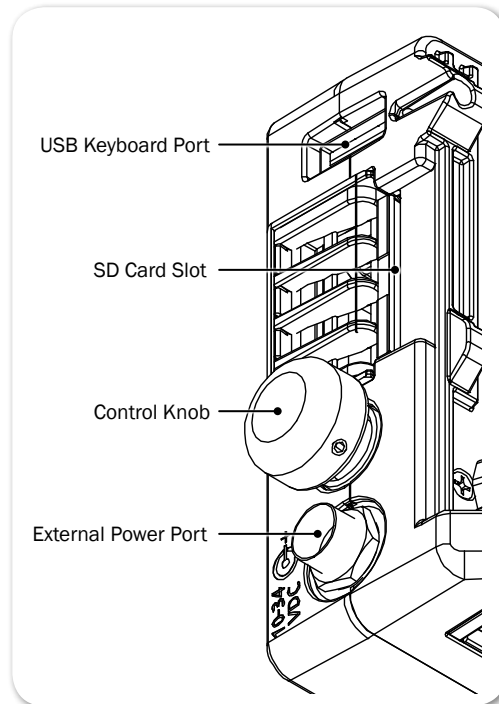

FEATURE	DESCRIPTION
USB Keyboard Port	Use this port to connect a USB keyboard for entering metadata and remote control.
SD Card Slot	Accepts standard SD cards (SDSC, SDHC, and SDXC) for loading firmware as well as saving and loading setup files.
Control Knob	Use the Control knob to navigate menu settings (by turning it) and selecting menu options (by pressing it in). It may also be used for scrolling across screen while in zoom mode.
External Power Port	Use to connect the PIX-E PSU. It accepts 10-34 VDC, threaded coaxial connector (pin positive, sleeve negative) with a 5.5 mm outer diameter and 2.1 mm inner diameter.

⚠ Caution regarding power supply: The PIX-E PSU must be connected to a protective earthing connection to ensure safety. The power supply's cord acts as the disconnect device. The cord must be readily accessible and remain readily operable.





Menus and Navigation

Whether working on the set or in the field, time is precious, and monitoring live recordings often requires quick adjustments in fast-paced workflows.

The PIX-E5 and PIX-E5H feature an on-screen display (OSD) and menus in an easy to navigate structure, with many options readily accessible via the touch screen or multi-functional soft key buttons.

The Main menu is one press of a button away with easy navigation via the Control knob or touch screen.

Topics in this section include:

- ▶ **Touch Screen and Tactile Controls**
- ▶ **Accessing the MAIN MENU Screen**
- ▶ **Toggling On-Screen Display Elements**
- ▶ **Toggling Soft Key Button Functionality**
 - ▶ Monitor Soft Keys
 - ▶ Record Soft Keys
- ▶ **Using Soft Key Menus**
- ▶ **Configuring the On-Screen Display**
- ▶ **Adjusting LCD Orientation**
- ▶ **USB Keyboard**

Touch Screen and Tactile Controls

Whether you want the quick efficiency of a touch-screen interface or prefer the tactile feedback of real buttons and want to keep the monitor's screen free of fingerprints, the PIX-E monitors offer a "best of both worlds" approach to user controls.

All PIX-E LCDs are touch-screen enabled, but the monitors also feature tactile buttons and a Control knob. Use the buttons to turn on or off monitor functions. Elements of menus and dialogs may be selected or adjusted by touching the screen or by using the Control knob, so you have the choice when it comes to navigating through the user interface.

While directions throughout this guide describe how to use the Control knob for navigation, touching the screen is often a quicker alternative.

Accessing the MAIN MENU Screen

The MAIN MENU screen displays an easy-to-navigate menu, organized with sub-menus, options, and parameters.

To access the MAIN MENU screen:

- ▶ Press the MENU button.

- ① *If you press and hold the MENU button, the Monitor menu appears across the lower portion of the screen.*

To navigate the Main menu with touch:

- ▶ Touch a menu item to access it.

To navigate the Main menu with the Control knob:

1. Turn the Control knob to move the highlight up or down the menu.
2. Press in the Control knob to access a highlighted option.

Sub-menus and their options are covered in more detail in sections related to those settings; however, the Main menu is provided with brief descriptions in the following table:

MAIN MENU	DESCRIPTION
Help	Displays a quick reference list of shortcut key combinations and their associated functions.
Recorder & Drives	Displays the settings relevant to recording and drive formatting.
Metadata	Displays the settings relevant to file-naming metadata stored in recorded files.
Video I/O	Displays the settings that define video input and output signals.
LCD Monitor	Displays the settings for configuring LUTs and Anamorphic Desqueeze.
Audio	Displays the settings that define headphone warning bells and (optional) PIX-LR setup.
Timecode	Displays the settings that define the timecode mode.
System	Displays the system settings, such as date and time options.
Save/Load Settings	Displays the options for saving customized settings to external storage media and loading those settings or reverting the device back to its factory settings.

Toggleing On-Screen Display Elements

The LCD displays a live or playback video image and the OSD, providing vital information superimposed over the video.

The OSD is made up of two display elements, which may be viewed or hidden:

- **Soft key labels** — Located along the bottom of the screen, these identify the current function of the soft key button directly below each label.
- **Information bar** — Located along the top of the screen, this bar is superimposed over the video image and shows transport status, the timecode, ABS time, audio meters for channels 1 and 2, file name, a clock, and other status information for media storage and power sources. An alternative view of the bar provides additional information, such as codec.

To show or hide soft key labels and/or the information bar:

- ▶ Press the Display soft key button. This button toggles through three display options:

- Show both information bar and soft key labels
 - Show soft key labels; hide information bar
 - Hide both information bar and soft key labels
- ① *Holding down the Display soft key button for at least one second will show alternative data on the information bar, such as the codec being used, and a file's resolution and rate.*

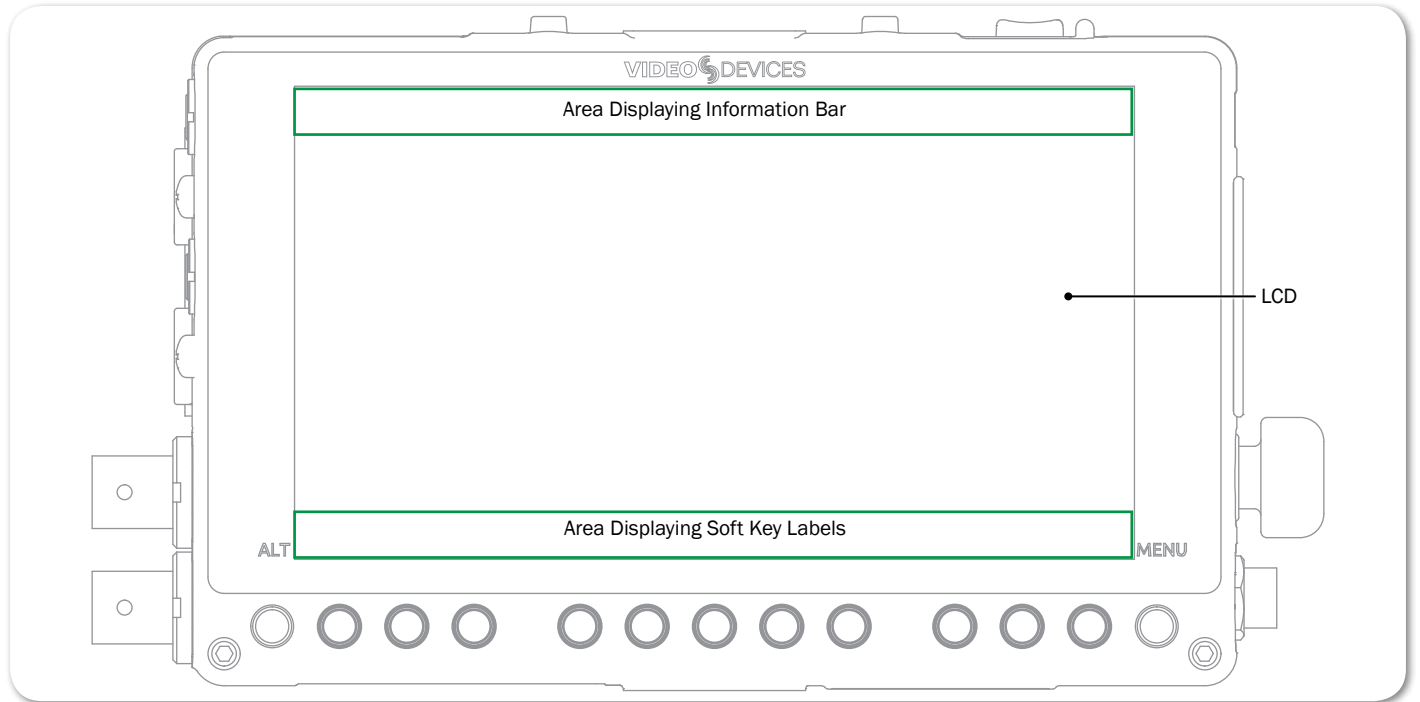

toggling Soft Key Button Functionality

The primary functionality of soft key buttons is to toggle on or off monitoring tools, such as: peaking, zebras, scopes, and more.

However, soft key buttons are multi-functional; their alternative functionality includes accessing the File List and Audio screens, and acting as transport controls for recording and playback.

To toggle between monitor and record soft key functions:

- ▶ Press the ALT button. The displayed soft key labels above the buttons will change, indicating their current function.
- ① *The Display soft key label remains on-screen regardless of which functionality is set for the other soft key buttons.*

The following sections provide more details about what soft key labels appear for the primary monitor versus alternative record functionalities.

Monitor Soft Keys

When soft key buttons are set for primary monitor functionality, the following soft key labels appear and the buttons function as described:

LABEL	DESCRIPTION
Display	Hides or reveals OSD elements: soft key labels and/or the information bar.
False	Toggles on/off the display of the false colors exposure assist tool.
Zebra	Toggles on/off the display of zebra stripes exposure assist tool.
4-Way	Splits the screen into four quadrants, showing the video image in one quadrant and three scopes—waveform, vectorscope, and histogram—in the other three.
WFM	Toggles on/off the full-screen display of the waveform monitoring tool.
Vector	Toggles on/off the full-screen display of the vectorscope monitoring tool.
Hist	Toggles on/off the full-screen display of the histogram monitoring tool.
LUT	Toggles on/off the selected LUT.
Zoom2x / Zoom4x	Toggles on/off the TapZoom functionality between different magnifications of the video image: 2x (200%) or 4x (400%). This setting also applies to zooming via use of the Control knob. ① <i>If TapZoom is disabled, the label for this soft key button will be NoZoom.</i>
Peak	Toggles on/off the display of peaking filter focus assist tool.
Marker	Toggles on/off the display of guide markers over the video image.

- ① Holding down most monitoring soft key buttons for more than a second will open a menu related to that button's functionality.

Record Soft Keys

When soft key buttons are set for alternate record functionality, the following soft key labels appear and the buttons function as described:

LABEL	DESCRIPTION
Display	Hides or reveals OSD elements: soft key labels and/or the information bar.
Audio	Displays the Audio screen. Track arm status, track name, input source, input gain, and input delay can be viewed and adjusted for every track. Also displays metering for all tracks.
Files	Accesses the Files screen, showing files recorded on the PIX-E5 as a list of clips.
Stop	Stops the recording or playback. When stopped, the label appears with a yellow background and a yellow square icon appears on the information bar. While stopped, pressing Stop reveals the next file name in the information bar.
<<	Press and hold to rewind, which will begin at 2x speed. After five seconds, rewind will occur at 16x speed. A quick press will jump back to previous cue marker, if any exist.

LABEL	DESCRIPTION
Play / Pause	Starts playback. During playback, the label appears with a green background and a green arrow icon appears on the information bar. The timecode, absolute time, and file name also appear green. Pressing the button during playback will pause playback. While paused, the Pause soft key label flashes, and the Pause icon flashes on the information bar.
>>	Press and hold to fast forward, which will begin at 2x speed. After five seconds, fast forward will occur at 16x speed. A quick press will jump forward to the next cue marker, if any exist.
Rec	Starts the recording. While recording, the label appears with a red background and a red circle icon appears on the information bar. The timecode, absolute time, and file name also appear red.
Cue +	Adds a cue marker at current record or playback frame.
Cue -	Removes current cur marker, as indicated on the information bar.

Using Soft Key Menus

Commonly used settings are accessed via Soft Key menus. These menus differ from the Main menu because they do not take up the entire screen. Instead, they are superimposed over the lower portion of the screen, allowing any live video to remain visible. Also, unlike the Main menu, the Soft Key menus may be accessed during playback or while recording.

To access any Soft Key menu:

- ▶ Press and hold the button for 1 second. The button’s menu, if available, will appear.

Specific buttons that feature Soft Key menus include:

BUTTON	DESCRIPTION
MENU	Called the Monitor menu, it displays settings for headphones and the LCD, such as brightness, contrast, and so forth.
False	The False menu displays options for setting the false color mode.
Zebra	The Zebra menu displays settings and related options for zebras 1 and 2.
WFM	The WFM menu displays settings and related options for the waveform monitor.
Vector	The Vector menu displays settings and related options for the vector-scope.
Hist	The Hist menu displays settings and related options for the histogram.
LUT	The LUT menu displays four options to choose from; these options will vary based on Main menu settings configured via MENU > LUTs.
Zoom	The Zoom menu displays options for enabling or disabling the TapZoom feature via the touch screen and zoom functionality via the Control knob.
Peak	The Peak menu displays settings and related options for peaking.
Marker	The Marker menu displays settings and related options for setting up guide markers.

① *Accessing a soft key menu for a monitor function will enable that monitor function*

if it is not already enabled. There is no such menu for the 4-Way soft key button. Also, there are no Soft Key menus available when soft key buttons are set to the record functionality.

The layout of these menus varies. The simplest menu will consist of a single row of options. The active option is highlighted in green.



Other such menus will feature settings in a nested tabular format. The tab of the active setting is outlined in green.



You can use the touch screen or Control knob to navigate soft key menus.

To use a Soft Key menu:

1. Do either of the following:
 - ▶ Use the Control knob by turning it to navigate tabbed settings and related options. Press in the Control knob to make a selection, and turn it to adjust any values, such as sliders.
 - ▶ Touch the screen to select a tabbed setting or related option. Touch and swipe your fingertip along sliders to adjust any values.
2. When finished modifying settings, exit the menu by pressing the soft key button again or touching elsewhere on the screen.

To reset the default of any Soft Key menu setting:

- ▶ With the menu’s setting displayed, press and hold the ALT button while pressing in the Control knob.

Configuring the On-Screen Display

The look of the OSD may vary depending on the configuration of certain settings available in the Monitor menu. For instance, the brightness or contrast of the display image might need adjusting. Or perhaps, the background for the information bar and all soft key menus appears opaque instead of transparent when superimposed over the video image.

To configure the Monitor settings:

1. Press and hold the MENU button for 1 second. The Monitor menu appears superimposed over the lower portion of the screen.
2. Adjust the following settings as needed to achieve the look you want.

SETTING	DESCRIPTION	OPTIONS
See-Thru	Use this setting to adjust the opacity of soft key menus and the information bar by increments of 25%. Set to 0% for fully opaque and 100% for full transparency. This setting does not affect the soft key labels, which are superimposed with a fully transparent background. The default is 50%.	0 to 100%
Brightness	Use this setting to adjust the brightness of the display image by increments of 1%. The default is 0%.	-20 to 20%
Contrast	Use this setting to adjust the contrast of the display image by increments of 1%. The default is 100%.	0 to 200%
Chroma	Use this setting to adjust the chroma level of the display image by increments of 1%. The default is 100%.	0 to 200%
Backlight	Use this setting to adjust the backlight level of the LCD by increments of 5%. The default is 70%.	0 to 100%

① *The Monitor menu also provides settings for adjusting headphone source and levels. For more information, see [Routing Audio Output](#). Also, if the PIX-LR is attached, an extra setting called PIX-LR LEDs appears, enabling adjustment of the accessory's LED brightness. For more information, see [Adjusting PIX-LR LED Brightness](#).*



Adjusting LCD Orientation



Because the monitor may be mounted upside down and turned to face either the camera operator or someone in front of the camera, the orientation of the LCD is adjustable, including the video image and positioning of the OSD elements.

To adjust LCD orientation:

1. Press MENU.
2. Select LCD Monitor > LCD Orientation.

There are four options when setting LCD orientation. Choose one based on the physical positioning of the monitor, as shown in the following table.

SETTING	DESCRIPTION
Normal	<p>Use this setting when monitor is mounted upright and facing the camera operator.</p> 
Mirrored	<p>Use this setting when monitor is mounted upright and facing person in front of camera.</p> <p>When mirrored, the information bar and soft key labels remain in place, but the video image is horizontally reversed.</p> 
Upside Down	<p>Use this setting when monitor is mounted upside down and facing the camera operator.</p> <p>When upside down, the video image is flipped so that it appears unchanged, while the information bar appears across the bottom of the screen, and the soft key labels are positioned across the top of the screen in reverse order. The reason for this is so each label remains paired with the appropriate soft key button, now physically located above LCD screen.</p> 

SETTING	DESCRIPTION
Upside Down and Mirrored	<p>Use this setting when monitor is mounted upside down and facing person in front of camera.</p> <p>When upside down and mirrored, the flipped video image is horizontally reversed, the information bar appears across the bottom of the screen, and the soft key labels are positioned across the top of the screen in reverse order. The reason for this is so each label remains paired with the appropriate soft key button, now physically located above LCD screen.</p> 
 SEE DEMO VIDEO	

USB Keyboard

PIX-E monitors support the use of a standard USB keyboard connected to the USB A connector on the right panel of the chassis. The keyboard may be used to navigate menus, enter text, and perform various other functions.

CONTEXT	KEY	ACTION
All	Shift	ALT button
	M, F12	MENU button
	F1-F12	Soft Key buttons. F1 is the first button to the right of the ALT button, F2 is the next button to the Right, etc.
	CTRL + R	Record
	Space	Play/Pause
	CTRL + S	Stop
	Esc	Cancel / Go back
Live View	Enter	Enable TapZoom
Live View (During record or playback)	Ctrl+Q	Add a cue marker
	Ctrl+Shift+Q	Delete a cue marker
Zoom mode	Enter	Switch between horizontal and vertical positioning.
	Up/Down arrow	Reposition center point
	Alt + Enter	Exit TapZoom

CONTEXT	KEY	ACTION
Audio screen & File screen	Up arrow	Move up one track or file
	Down arrow	Move down one track or file
	Enter	Select track or file
	Esc	Exit to main screen
Audio screen with track selected	Up arrow	Move one field to the right
	Right arrow	Move one field to the right
	Down arrow	Move one field to the left
	Left arrow	Move one field to the left
	Enter	Select field for editing
Audio screen with Delay field selected	Up arrow	Increment delay by 10 ms
	Down arrow	Decrement delay by 10 ms
	Enter	Accept edits and unselect both the edited field and the track
	Esc	Accept edits and unselect both the edited field and the track
Audio screen with Gain field selected	Up arrow	Increment gain by 1 dB
	Down arrow	Decrement gain by 1 dB
	Enter	Accept edits and unselect both the edited field and the track
	Esc	Accept edits and unselect both the edited field and the track
Audio screen with Source field selected	Up arrow	Select the next source up
	Down arrow	Select the next source down
	Enter	Accepts current selection and unselect both the edited field and track
	Esc	Accepts current selection and unselect both the edited field and track
On-screen keyboard displayed	Printable keys	Are entered into the text field
	Enter	Selects the currently highlighted button on the on-screen keyboard
	Esc	Rejects edits closes the on-screen keyboard
	Arrow keys	Move the highlight on the on-screen keyboard
	Backspace	Deletes one character to the left
	Del	Deletes one character to the right

PIX-Assist Monitoring Suite

The PIX-E5 and PIX-E5H are powerful, versatile field monitors designed for use with virtually any production camera.

Their LCD's accurate color representation and excellent off-axis visibility, even on very sunny days, provide a powerful visual aid for achieving precise focusing, exposure, color balance, and framing, enabling the cinematographer to achieve their creative vision.

The monitors feature the complete PIX-Assist™ suite of monitoring tools, offering the best graphical representation of your video signal so you can be sure what you see on the monitor is exactly what you want in a video recording.

Topics in this section include:

- ▶ **Overview**
- ▶ **Assist Tools**
 - ▶ Using False Colors
 - ▶ Using Zebras
 - ▶ Using Zoom
 - ▶ Using Peaking
- ▶ **Scopes**
 - ▶ Using the Waveform Monitor
 - ▶ Using the Vectorscope
 - ▶ Using the Histogram
- ▶ **Using 4-Way Monitoring**
- ▶ **Using LUTs**
 - ▶ Enabling LUTs on SDI Output
 - ▶ Using Custom LUTs
- ▶ **Using Anamorphic Desqueeze**
- ▶ **Using Markers**
- ▶ **Resetting Monitor Defaults**

Overview

The PIX-Assist suite of monitoring tools consists of a collection of focus, exposure, and framing assist tools plus scopes. These tools affect the video signal displayed on the monitor, and the scopes provide a live graphical analysis of chrominance and luminance information in the video signal.

These monitoring features are controlled from soft key buttons, above which are soft key labels indicating the button's current functionality.

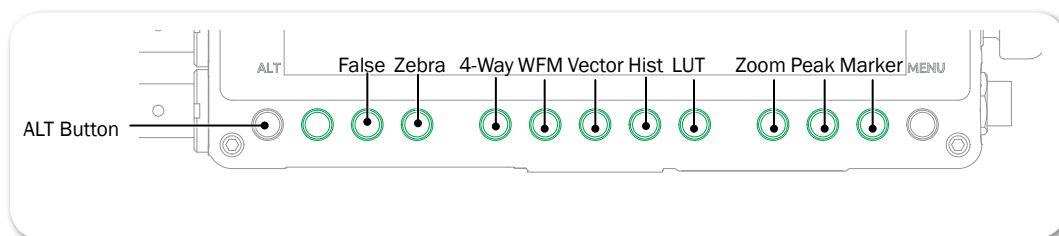

① *If the monitor functionality of soft keys is not displayed, press the ALT button.*

When a monitoring tool is activated, the label above the corresponding button appears with a green background.

Assist Tools

The assist tools are those used to aid focusing and making adjustments for exposure. The tools include: false colors, zebras, zoom, and peaking.

Using False Colors

False colors provides a quick way to achieve good exposure levels. They are typically used to indicate over- and under-exposed regions in the video, as well as aiding in setting exposure for skin tone and middle gray. The PIX-E monitors offer two modes: 4-color and 12-color.

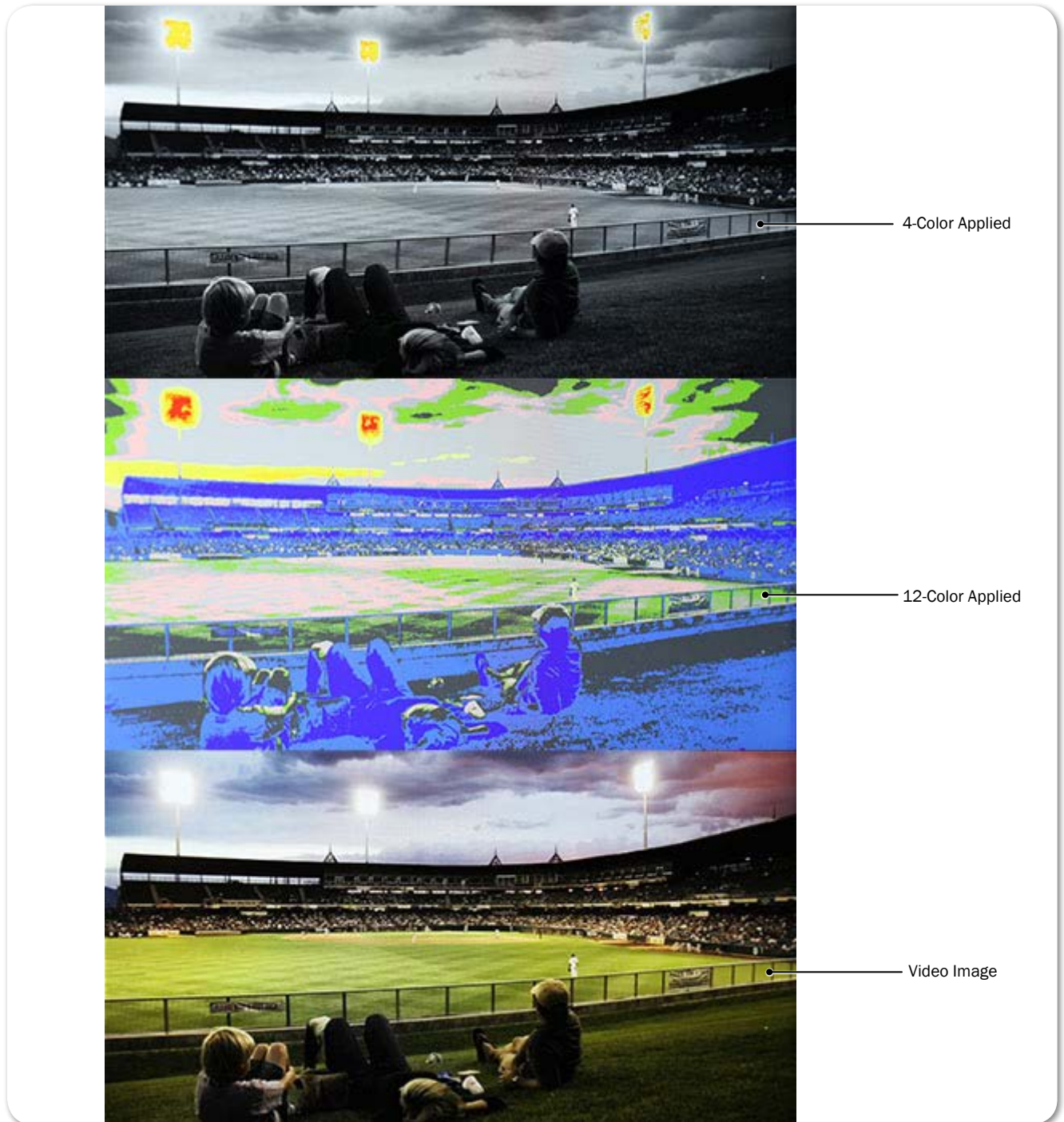

The 4-color mode is ideal for quickly identifying over- and under-exposed regions. Under-exposed regions are highlighted blue and over-exposed regions as yellow or red. All exposure levels in between are displayed as grayscale.

The 12-color mode is also used for identifying over- and under-exposed regions; however, it also provides a quick way to achieve correct exposure levels for skin tone and middle gray. For example, correctly exposed Caucasian skin tone typically shows as pink.

To enable or disable false color:

- ▶ Press the False soft key button.

To adjust false color settings:

1. Press and hold the False soft key button. The False menu appears.

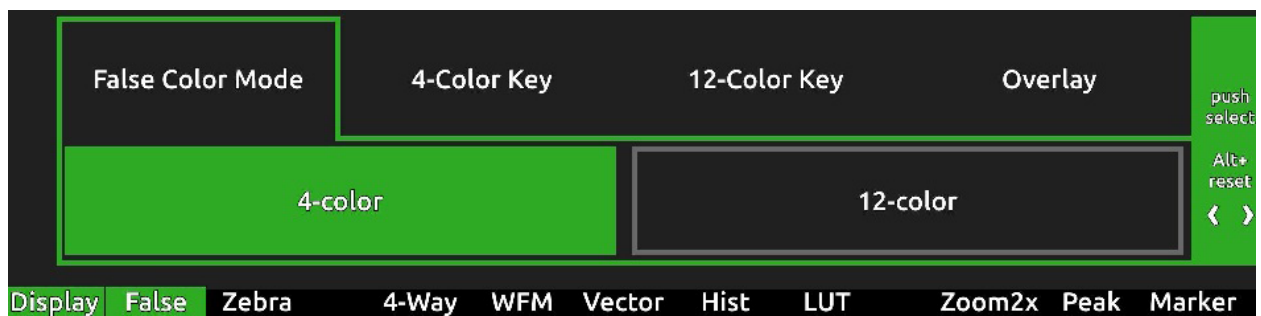

2. Use the touch screen or Control knob to change settings.

SETTINGS	OPTIONS	DESCRIPTION				
False Color Mode	<ul style="list-style-type: none"> • 4-color 	The 4-step mode divides the monitor signal into 4 luminance ranges, assigning a color to all but one range; this range is displayed without chroma.				
	<ul style="list-style-type: none"> • 12-color 	<p>The 12-step mode divides the monitor signal into 12 luminance ranges, assigning a color to each one.</p> <p>Red and orange (95-108) ranges indicate over-exposure.</p> <p>Middle grays and skin tones typically fall in the green, pink, and medium to light gray (43-78) range.</p> <p>Blue and white (0-12) ranges indicate under-exposure.</p>				
4-Color Key	<ul style="list-style-type: none"> • 0 • 3 • 95 • 100 	<div style="border: 1px solid black; padding: 5px;"> <p style="text-align: center;">4-Color Key</p> <table style="width: 100%; border-collapse: collapse;"> <tr> <td style="background-color: red; color: white; text-align: center;">100-108 Red</td> </tr> <tr> <td style="background-color: orange; color: white; text-align: center;">95-99 Orange</td> </tr> <tr> <td style="background-color: white; color: black; text-align: center;">3-98 N/A</td> </tr> <tr> <td style="background-color: blue; color: white; text-align: center;">0-2 Blue</td> </tr> </table> </div>	100-108 Red	95-99 Orange	3-98 N/A	0-2 Blue
100-108 Red						
95-99 Orange						
3-98 N/A						
0-2 Blue						

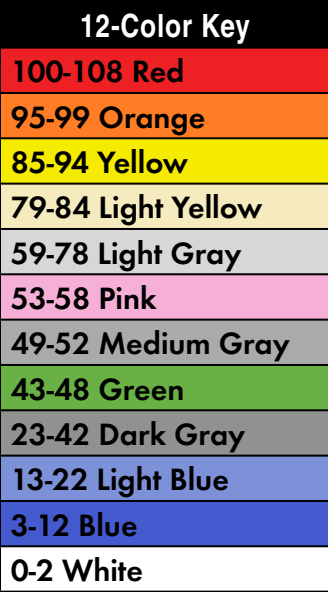
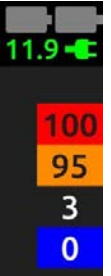
SETTINGS	OPTIONS	DESCRIPTION	
12-Color Key	<ul style="list-style-type: none"> • 0 • 3 • 13 • 23 • 43 • 49 • 53 • 59 • 79 • 85 • 95 • 100 		
Overlay	<ul style="list-style-type: none"> • On • Off 	<p>If enabled, the key for the chosen color mode is displayed when false colors are applied.</p> <p>For instance, if 4-color mode is chosen and Overlay is turned on, then the 4-Color key is displayed along the right side of the screen, just below the battery and power icons (as shown).</p>	

3. Press the False soft key button again to exit.

Using Zebras

Zebras provides an alternative method for identifying exposure levels in an image. They appear as black and white diagonal stripes that are superimposed over regions of an image that exceed a threshold or specific value range of luminance. PIX-E monitors have three modes: Zebra 1, Zebra 2, and Zebra 1+2. The following image shows both zebra 1+2 overlays with default settings.

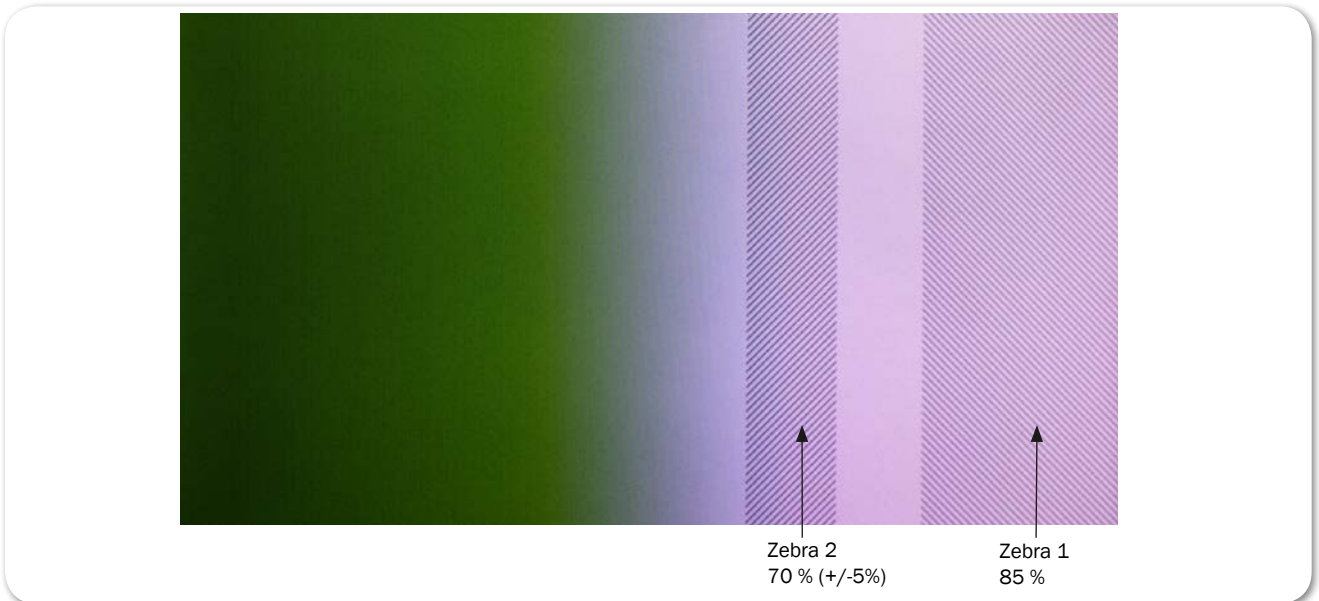

Zebra 1 stripes are forward leaning and are typically set to identify a particular brightness range (value +/-5%), such as skin tones or mid tones.

Zebra 2 stripes are backward leaning and are typically set to identify when a specific brightness level is exceeded. They are often set to identify over-exposed image or when textures and details in whites start to get lost.

Zebra 1+2 simultaneously superimposes both on the video image.

To enable or disable zebras:

- ▶ Press the Zebra soft key button.

The button is a toggle, so pressing it a second time turns off the zebra overlay. When enabled, the Zebra soft key label appears with a green background.

To adjust zebra settings:

1. Press and hold the Zebra soft key button. The Zebra menu appears.



2. Use the touch screen or Control knob to change settings.

SETTING	DESCRIPTION	OPTIONS
Select Zebra Display	Sets which zebra is displayed when zebras are enabled.	<ul style="list-style-type: none"> • Zebra 1 • Zebra 2 • Zebras 1 + 2
Zebra 1 Level	The luminance range where Zebra 1 will be displayed. The top of the range is 5% above this setting, and the bottom of the range is 5% below.	<ul style="list-style-type: none"> • 0% - 105%
Zebra 2 Threshold	Zebra 2 will be displayed for signal above this threshold.	<ul style="list-style-type: none"> • 0% - 108%

3. Press the Zebra soft key button to exit.

Using Zoom

For fast and precise focusing on both static and moving subjects, PIX-E monitors provide 2x and 4x magnification and the ability to rapidly adjust the center point of focus. Zoom can be controlled using the touch screen or the Control knob.

TapZoom™ is the fastest way to zoom in and out on a subject. Utilizing the PIX-E monitors' touch screen, TapZoom lets focus pullers and camera operators check focus by simply tapping a point on the video image to zoom in on a target. A second tap zooms back out.

For those who prefer to not use the touch screen, zoom can also be activated using the Control knob.

To zoom in on a point of interest:

- ▶ Tap that point in the image.
- ▶ Press in the Control knob.

To zoom out to full image:

- ▶ Tap center of screen.
- ▶ Press ALT+Control knob.



Magnification is controlled by a Zoom soft key button, and the soft key label displays the current setting related to the Zoom feature.

SOFT KEY LABEL	DESCRIPTION
Zoom2x	When set to 2x, activating zoom will zoom with 200% magnification.
Zoom4x	When set to 4x, activating zoom will zoom with 400% magnification.
NoZoom	Indicates when zoom functionality is disabled.

When zoomed in, the monitor centers the screen on the tapped target, displays the word ZOOMED in red, and provides a rectangular locator graphic to pinpoint zoomed area within the full image. That location is known as the center point. Below the locator graphic is POS, or repositioning options, with arrows indicating the direction in which you can move that center point.

To reposition the center point:

- ▶ Swipe your fingertip across screen to move the zoomed-in image around on the screen. The center point is repositioned accordingly.
- ▶ Turn the Control knob to reposition the center point. Press the knob in to switch between horizontal or vertical positioning.

Targets in Motion

Repositioning the center point works well for stationary subjects, but if a subject moves, a quick tap in certain zones can help recenter the zoomed view, keeping your shot on target. The screen is split into nine zones.

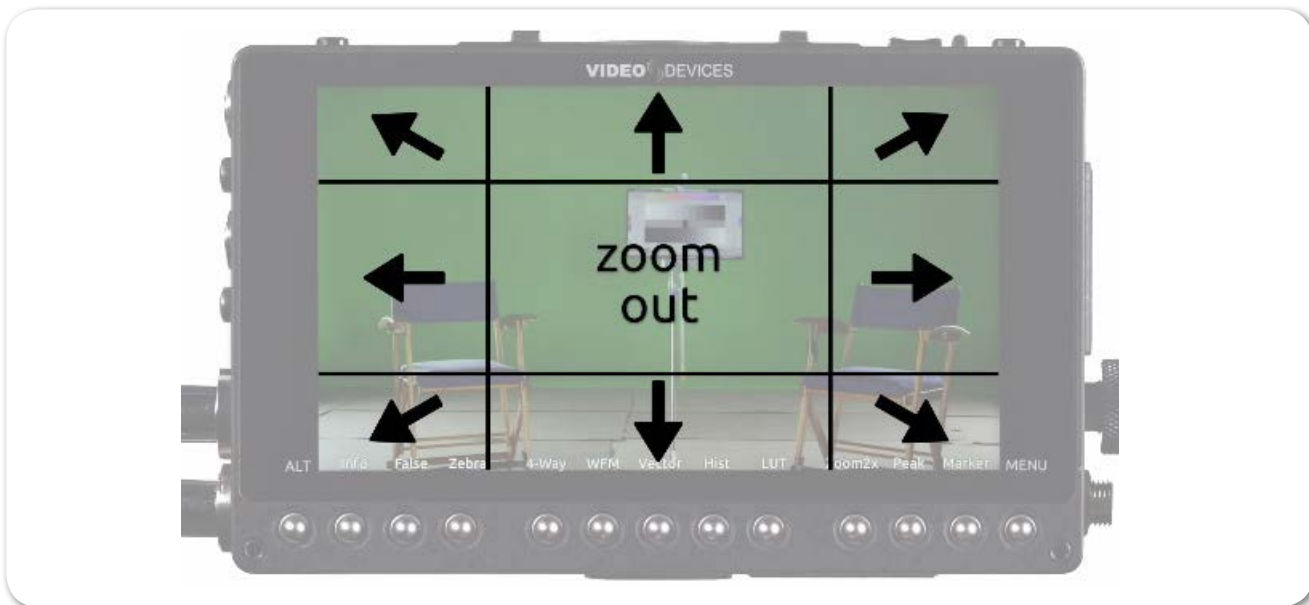

While zoomed in, you may tap toward the edges of the screen to follow a moving subject around within a shot, or tap the center of the screen to return to a non-magnified view of the overall shot.

Enabling or Disabling Zoom

Zoom is a feature that may be disabled.

To enable or disable Zoom:

1. Press and hold the Zoom soft key button. The Zoom menu appears superimposed over the lower portion of the screen.
2. Do one of the following:
 - ▶ Select Zoom Enabled to turn on zoom functionality.
 - ▶ Select Zoom Disabled to turn off zoom functionality.

When disabled, the Zoom soft key button no longer toggles between magnification settings, and its soft key label displays NoZoom.

Using Peaking

Peaking is a focus-assist tool that makes it easy to discern an object in focus by visually highlighting sharp edges. It can also be used in conjunction with zoom to rapidly achieve ultra-precise focus.

PIX-E provides a range of options to help make the sharp focused edges stand out regardless of the color and content of the video image. These options include user-customizable peaking sensitivity, color, throb, background contrast and background color.

The following comparison demonstrates the effect of peaking (shown in red) on an monochrome image with a shallow depth-of-field and a short focal length

(top) and the same image with a longer focal length (bottom).

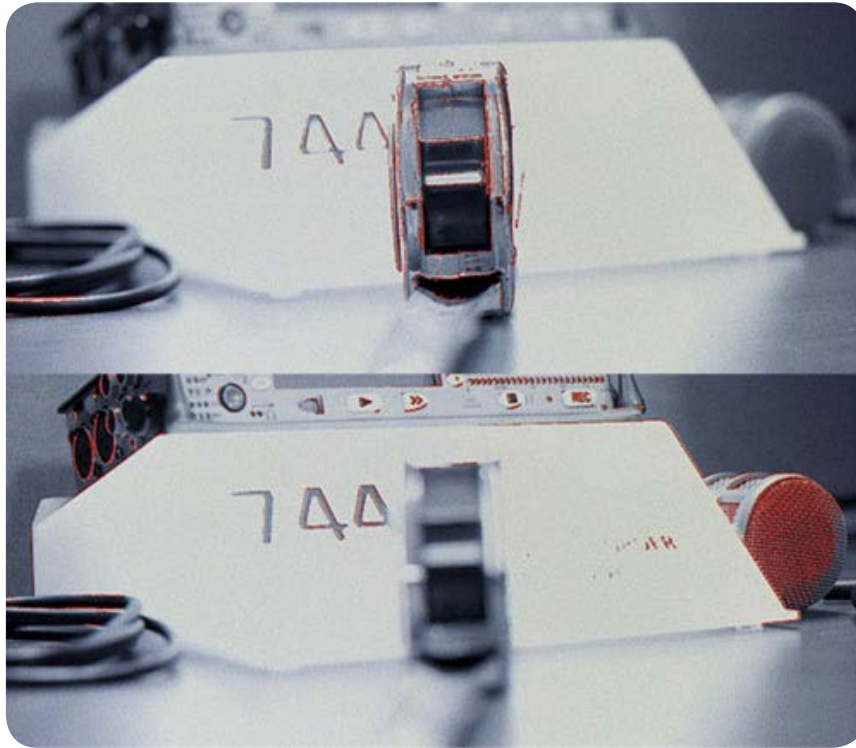

To turn on peaking:

- ▶ Press the Peak soft key button.

To adjust various settings related to peaking:

1. Press and hold the Peak soft key button. The Peak menu appears.



2. Use the touch screen or Control knob to change settings.

SETTING	DESCRIPTION	OPTIONS
Peaking Sensitivity	Use to define the sensitivity level for peaking. The lower the value, the less sensitive the peaking filter will be to non-sharp edges. The default is 50%	<ul style="list-style-type: none"> • 5% - 100%
Peaking Color	Choose the color to be used to highlight the sharp edges in a video image. To help the edges stand out, use a color that is not dominant in the image. The default color is Red.	<ul style="list-style-type: none"> • Red • Green • Blue • White • Yellow

SETTING	DESCRIPTION	OPTIONS
Peaking Throb	Set the peaking color to flash by turning this setting on and setting the speed. The default is Off.	<ul style="list-style-type: none"> • Off • Slow • Fast
Background Contrast	Sets the contrast of the background image. Lower the value to help the highlights be more visible. The default is 100%.	<ul style="list-style-type: none"> • 0% - 100%
Background Color	Sets the background image as Color or Monochrome. The default is Color.	<ul style="list-style-type: none"> • Color • Monochrome

3. Press the Peak soft key button again to exit.

Scopes

Scopes provide cinematographers and videographers the ability to accurately set exposure and color balance as well as make creative choices about the look of a scene.

PIX-E monitors offers three types of scope: the waveform monitor, the vector-scope, and the histogram. Each scope plots color and/or brightness information onto a graph which can be viewed full screen over an opaque background or superimposed over the video image. There is also a 4-way monitoring mode for viewing multiple scopes with the video image.

Using the Waveform Monitor

The waveform monitor (WFM) is a tool for checking and aiding in setting exposure levels both for brightness and color. Its precision graticule provides more detail and accuracy than either false colors or zebras. Use WFM to check exposure for skin tone, consistent background lighting, background separation on green screen shots, and for avoiding over-saturated colors.

The WFM's vertical axis ranges from -10% to 110% and represents brightness (luma) or color (chrominance) levels for each pixel in an image. 100% corresponds to nominal white and 0% to black. The -10% and 110% limits allow for monitoring of super blacks and whites.

The WFM's horizontal axis corresponds to the position of image content going from left to right.

The monitor provides four WFM modes: Luma (white), Luma (green), RGB Overlay, and RGB Parade.

The following table provides illustrative examples for each of these modes:

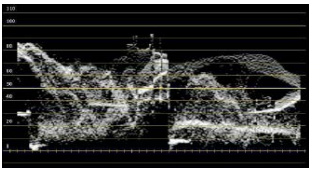
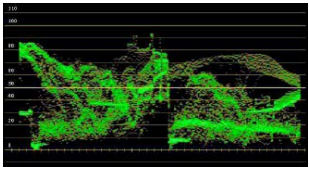
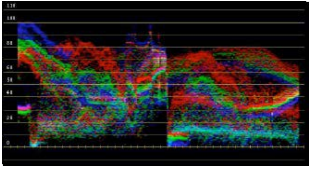
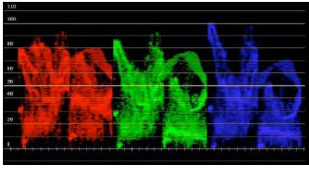
TYPE	EXAMPLE	DESCRIPTION
Luma (white)		Displays luminance only trace in white or green. Use to: <ul style="list-style-type: none"> accurately set exposure for skin tone where typical range is 45% (darker tones) to 60% (lighter tones). help to set consistent background lighting. For example, a uniform background lighting will appear as an approximately flat horizontal trace from left to right.
Luma (green)		
RGB Overlay		Displays red, green, and blue (RGB channels) color information overlaid one over another or horizontally, one after another: red, green, and then blue. Use to: <ul style="list-style-type: none"> check if RGB levels are clipping. This information may not show up in Luma mode. check white balance. RGB levels should be the same. check adequate separation between green, red and blue for green screen shots.
RGB Parade		

To view/hide the waveform monitor:

- ▶ Press the WFM soft key button.

The button is a toggle, so pressing it a second time turns off waveform.

To adjust percentage of intensity (trace brightness) of the WFM:

- ▶ While viewing the WFM, rotate the Control knob. The level is displayed on screen next to the Control knob.

To adjust waveform monitor settings:

1. Press and hold the WFM soft key button. The WFM menu appears.
2. Use the touch screen or Control knob to change settings.

SETTING	DESCRIPTION	OPTIONS
Waveform Type	The type of waveform monitor to display.	<ul style="list-style-type: none"> Luma (white) Luma (green) RGB Overlay RGB Parade
Background Video Contrast	The contrast level of the background video. The default is 35%. ① For a black background, adjust to 0%.	<ul style="list-style-type: none"> 0% - 100%

Using the Vectorscope

The vectorscope is a circular graphical tool for monitoring color (chrominance) information. It can be used for helping eliminate unwanted color casts (offsets), checking white and black balance, ensuring color saturation falls within a legal broadcast color gamut, and for making creative choices about overall look.

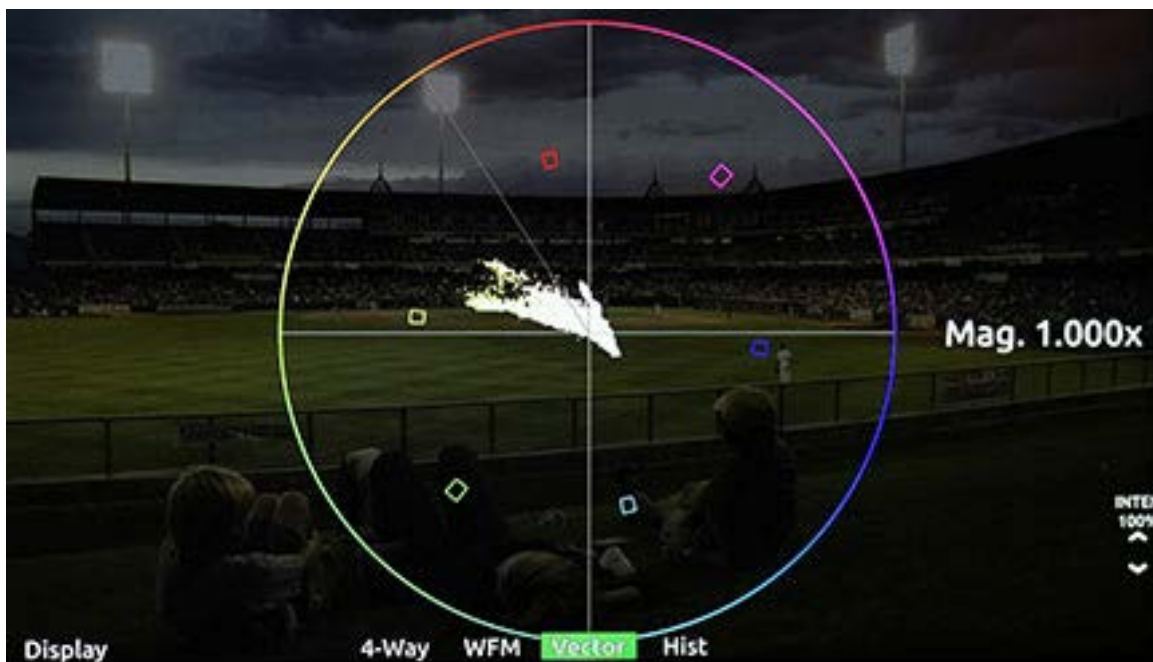

Color saturation is determined by the distance from the center of scope - the more saturated (vivid) a color, the further its trace reach is from the center. A grayscale image should appear as a dot in the center of the scope.

Color hue is determined by the direction or angle of the trace. Small boxes represent target values for fully saturated REC 709 primary and secondary color bars (red, green, blue, yellow, magenta, cyan). The line between the red and yellow target boxes that runs from center to outer circumference indicates skin tone.

- ① *Tip: To quickly check for color offset, view the vectorscope while performing a white and/or black balance. The trace should appear as a fuzzy dot (for white) or smaller dot (for black) in the center of the scope.*

To view/hide the vectorscope:

- ▶ Press the Vector soft key button.

To adjust percentage of intensity (trace brightness) of the vectorscope:

- ▶ Rotate the Control knob while viewing the vectorscope. The level is displayed on screen next to the Control knob.

To adjust vectorscope settings:

1. Press and hold the Vector soft key button. The Vectorscope menu appears.

2. Use the touch screen or Control knob to change settings.

SETTING	DESCRIPTION	OPTIONS
Vectorscope Magnification	Set the magnification multiplier of the vectorscope.	• 1.000x - 5.000x
Background Video Contrast	The contrast level of the background video. The default is 35%. ① <i>For a black background, adjust to 0%.</i>	• 0% - 100%

Using the Histogram

The histogram is a tool for checking overall brightness (luma) or color level (chrominance) within an image. It displays how many pixels there are at each brightness or color level. The horizontal axis represents luma level with black being on the left and white on the right. The vertical axis represents the relative number of pixels at that luma level. Use it to quickly determine that you are capturing the full dynamic range - most pixels should be distributed broadly around the center of the horizontal axis, not hard left (under-exposed) or hard right (over exposed).

The horizontal range of the histogram is -10% to 110%, matching the vertical range of the WFM, where 0% is legal black and 100% is legal white. The -10% and 110% limits allow for monitoring full range 'super blacks' and 'super whites'.

The monitor provides 4 histogram modes: Luma (white), Luma (green), RGB Overlay, and RGB Parade. The following table provides illustrative examples for each of these modes:

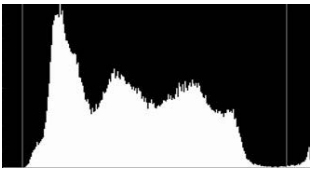
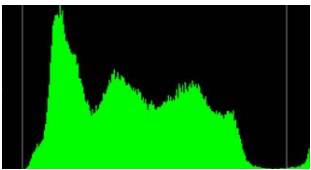
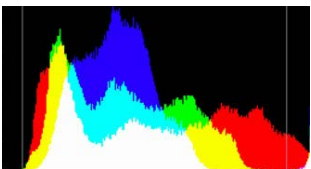
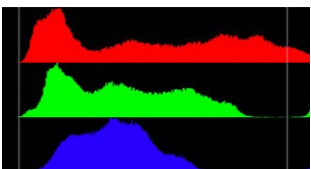
TYPE	EXAMPLE	DESCRIPTION
Luma (white)		Displays luma only trace in white.
Luma (green)		Displays luma only trace in green, offering a look reminiscent of green-screen oscilloscopes.
RGB Overlay		Displays RGB pixel distribution overlaid, one over another, as a horizontal trace.
RGB Parade		Displays RGB pixel distribution overlaid vertically one after another: red first, green second, and then blue.

To view/hide the histogram:

- ▶ Press the Hist soft key button.

To adjust histogram settings:

1. Press and hold the Hist soft key button. The Vectorscope menu appears.
2. Use the touch screen or Control knob to change settings.

SETTING	DESCRIPTION	OPTIONS
Histogram Type	Sets the type of histogram to display.	<ul style="list-style-type: none"> • Luma (white) • Luma (green) • RGB Overlay • RGB Parade
Background Video Contrast	The contrast level of the background video. The default is 35%. ⓘ For a black background, adjust to 0%.	<ul style="list-style-type: none"> • 0% - 100%

Using 4-Way Monitoring

4-Way monitor mode splits the screen into 4 quadrants, simultaneously displaying the video signal, histogram, waveform, and vectorscope. This provides a great overview of exposure and color attributes of the incoming video.

The following image shows an example of the display while in 4-way monitoring mode.

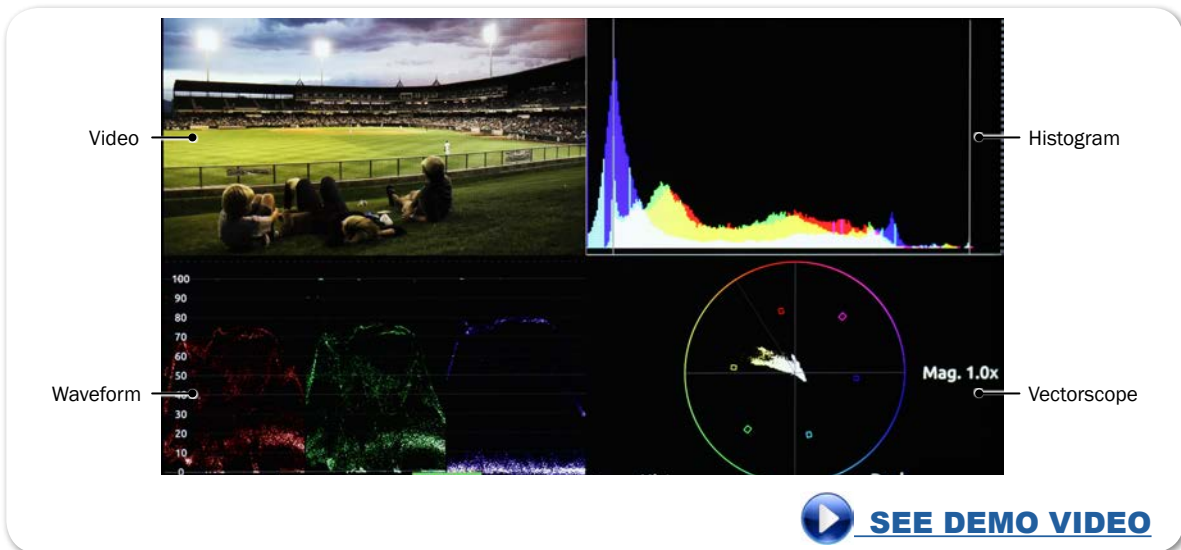

When in 4-way monitoring, a tap on any one of the four quadrants will enlarge the view displayed in that quadrant to full screen.

To begin 4-way monitoring:

- ▶ Press the 4-Way soft key button.
- ▶ Tap the screen while viewing the full-screen histogram, vectorscope, or waveform monitor.

The overlay monitoring assist tools are still available when 4-way is displayed. For instance, you can turn on 4-way monitoring and view the video in the top left quadrant with peaking, false color, or zebras overlaid on the image.

To exit 4-way monitoring:

- ▶ Press the 4-Way soft key button again.
 - ▶ Tap any one of the four quadrants to expand that view full screen.
- ① *While a tap will expand one of the three scopes full screen, a second tap will toggle back to 4-way monitoring. That is not the case with the video quadrant; a tap there will exit 4-way and restore full screen viewing of the video signal. A second tap afterward will, if TapZoom is enabled, zoom in on the image.*

Using LUTs

To aid onset viewing, most camera manufacturers provide monitoring LUTs (lookup tables) to convert the cameras' Log output into easily viewed imagery that more accurately represents the final image.

The PIX-E monitors come equipped with several standard LUTs, but custom LUTs may also be used via SD card or SpeedDrive. When a LUT is active, it is applied to the LCD, video outputs, and is baked into the recorded H.264 file but not ProRes recordings.

This is ideal for simultaneously recording a full dynamic range, log-encoded ProRes master file for the edit suite and a REC709 H.264 file suitable for normal viewing.

To activate or deactivate a LUT:

- ▶ Press the LUT soft key button. The LUT soft key label appears green when a LUT is activated.

To compare LUTs and view the name of the currently selected LUT:

1. Press and hold the LUT soft key button.

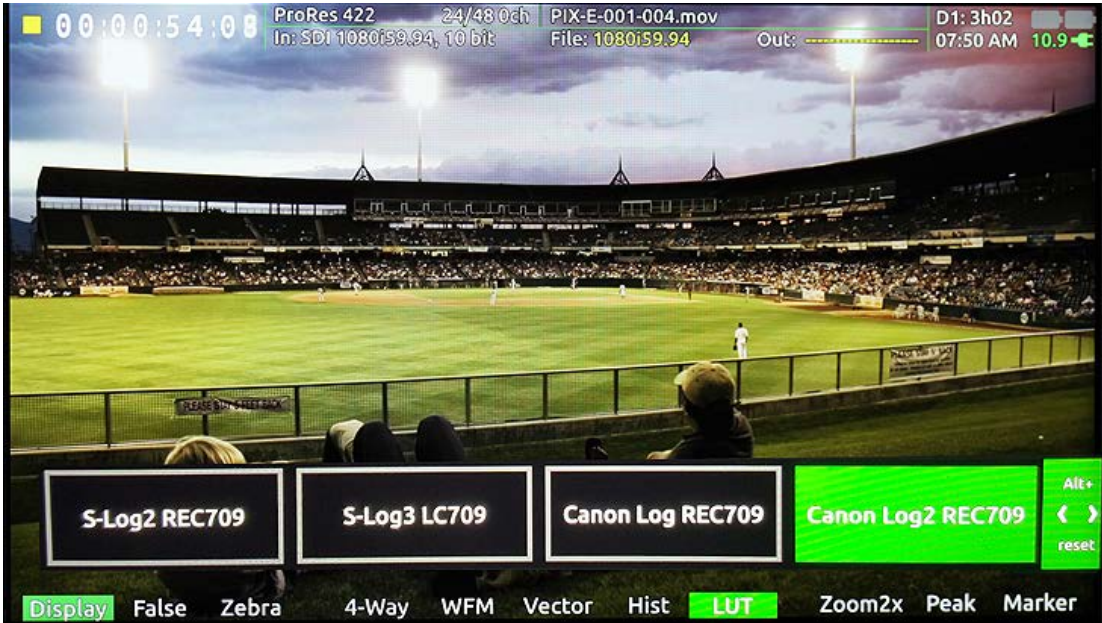

The LUT menu appears superimposed over the image, along the bottom of the screen, with four LUT options. The currently applied LUT appears highlighted in green.

① *The four options in the menu will vary depending on how LUTs are configured.*

2. Tap each option to view the video image based on the chosen LUT.

To configure the LUT menu options:

1. Press MENU.
2. Select LCD Monitor.

LCD MONITOR	
1. Select LUT1	S-Log2 REC709
2. Select LUT2	S-Log3 LC709
3. Select LUT3	Canon Log REC709
4. Select LUT4	Canon Log2 REC709
5. LUT SDI Output	Always Off
6. Anamorphic Desqueeze	Off
7. Anamorphic Sensor Ratio	4x3
8. Anamorphic Lens Ratio	1.33x
9. Anamorphic Display	Full
10. LCD Orientation	Normal

3. Define each of the four options: LUT1, LUT2, LUT3, LUT4 by selecting from the settings listed. The following table describes the standard settings

available.

SETTING	DESCRIPTION
Off	Select if you want one of the four options available via the LUT soft key button menu to be Off. This is useful as a quick LUT bypass when comparing different looks.
Canon Log REC709	Canon logs are provided for use with Canon® cameras.
Canon Log2 REC709	
S-Log2 REC709	S-logs are provided for use with Sony® cameras.
S-Log3 LC709	
S-Log LC709A	
V-Log REC709	The V-log is provided for use with Panasonic® cameras.

- ① *The list could vary depending on if any custom LUTs are in the LUTs folder on the attached SD card or SpeedDrive. Custom LUTs are appended to the end of the list.*

Enabling LUTs on SDI Output

On the PIX-E5, LUTs may be enabled or disabled on the SDI output. So, end-users can determine whether LUTs get applied to the output signal. For instance, the SDI output may be sent to an external monitor where other crew members want to view the image with a certain LUT applied, or the SDI output may be sent to an external recorder, in which case the video signal is sent without LUTs applied.

To configure LUT SDI Output:

1. Press MENU.
2. Select LCD Monitor.
3. Set LUT SDI Output to on of the following options: Always Off, Always On, or Change with LUT Button. The last option toggles LUT SDI Output on and off when the LUT soft key button is pressed.

Using Custom LUTs

Custom lookup tables in .cube file format may be used with PIX-E monitors from either a SpeedDrive or SD card. Supported .cube file formats include: 16x16x16, 17x17x17, 32x32x32, and 33x33x33.

To use a custom LUT:

1. Ensure the SpeedDrive or SD card has been formatted by the PIX-E monitor. For more information on formatting drives with the PIX-E monitor, see [Formatting Storage Drives](#).

When the drive or card is formatted by the PIX-E monitor, a LUTs folder is created. All custom LUTs *must* be placed in this folder for the monitor to properly identify and retrieve the .cube files.

① *Do not use a period in the LUT file name.*

2. Insert the SpeedDrive or SD card into a computer.
3. Copy the custom LUT (.cube file) to the LUTs folder on the SpeedDrive or SD card.
4. Mount the SpeedDrive or insert the SD card into PIX-E monitor.

All custom LUTs will be appended to the end of the list available for selection via MENU > LCD Monitor.

Using Anamorphic Desqueeze

An anamorphic lens optically distorts an image, so why would anyone want to use such a lens?

Originally, anamorphic lens were developed so that filmmakers could record widescreen format while still using standard 35 mm film. Cameras were fitted with lens that optically compressed (or squeezed) the image onto the film frame. Later, the movie was projected onto the screen through a projection system with another lens that reversed the compression.

Now, however, there are other benefits to using anamorphic lens, such as:

- Capture wider, crisper “landscape” imagery. For instance, a traditional anamorphic lens with a 2x squeeze means that twice the amount of horizontal information can be captured compared to spherical lens.
- Combine anamorphic lens with a digital sensor for certain effects, such as lens flare and out of focus bokeh that appear elongated (or oval) as opposed to circular.

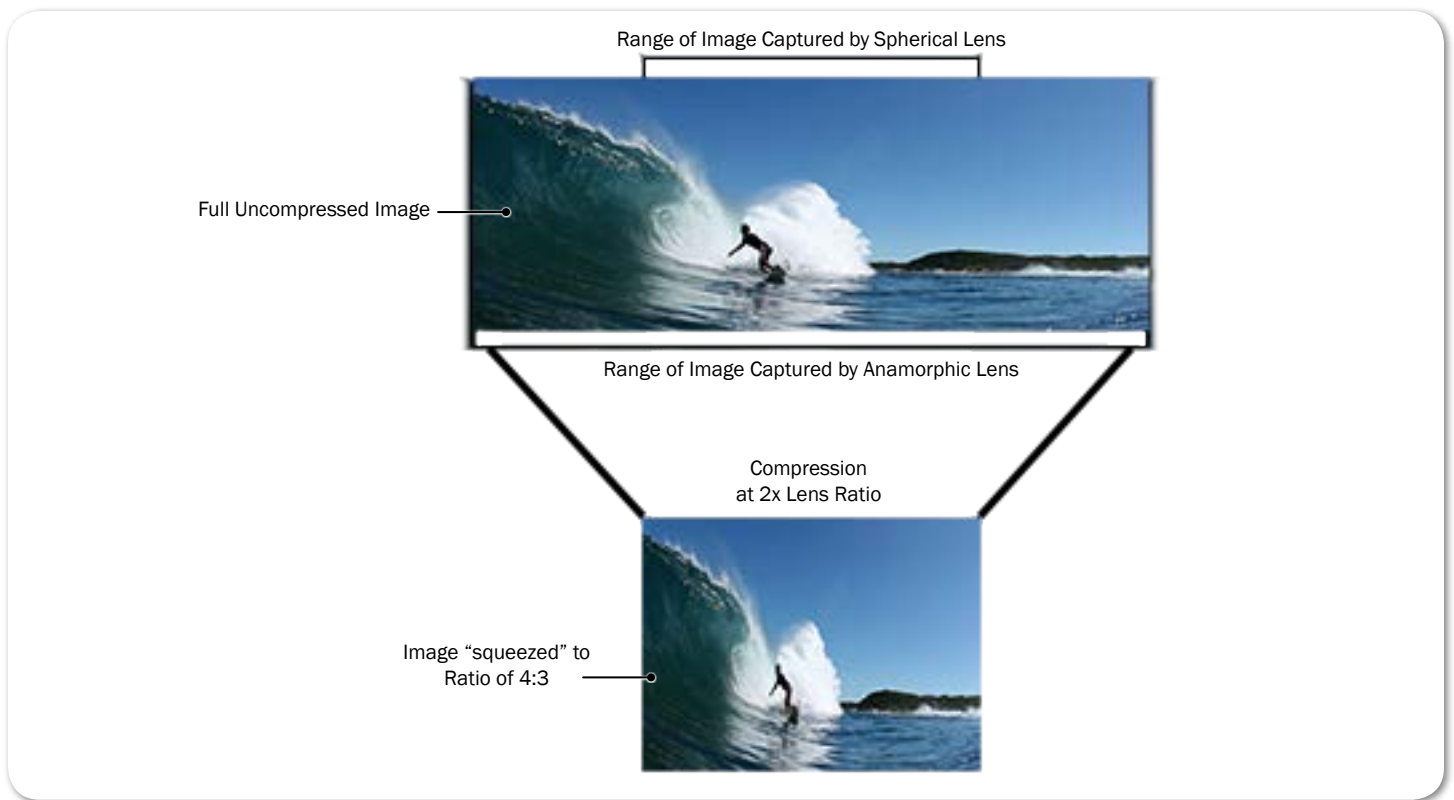

The PIX-E monitors have the ability to “desqueeze” an image to the LCD and SDI/HDMI outputs during both monitoring input and playback. The process stretches out the horizontally squeezed images that result from cameras using anamorphic lens so that objects in the images, when displayed on the LCD or via outputs, do not appear elongated and thinned.

As shown in the following diagram, anamorphic display options include decompression that displays the full horizontal information of the original image or stretched to a SMPTE 2.39:1 aspect ratio.

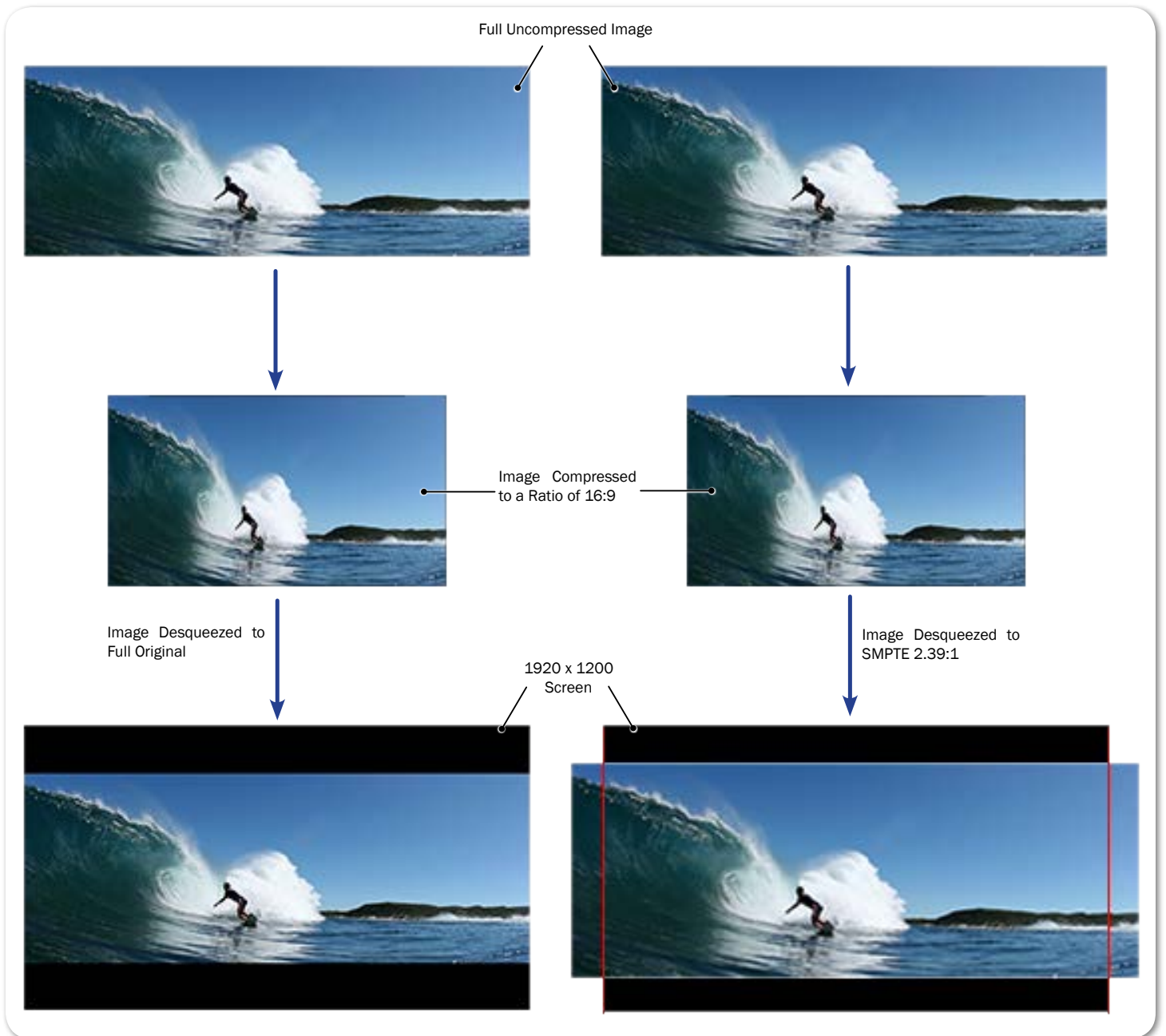

When anamorphic desqueeze is applied, letter-boxing and/or cropping may occur, depending on anamorphic lens ratio, sensor ratio, and display settings; however, this does not affect the recorded image.

To configure and enable anamorphic desqueeze:

1. Press MENU.
2. Select LCD Monitor.
3. Ensure the Anamorphic Sensor Ratio is set to the proper aspect ratio being used by the camera's sensor. Options include:

OPTION	DESCRIPTION
4x3	Standard NTSC ratio historically used for television broadcasts.
16x9/17x9	When this setting is selected, the PIX-E monitor will automatically detect and use whichever ratio (16x9 or 17x9) the camera is sending.

4. Ensure the Anamorphic Lens Ratio is set correctly, based on the lens being used. Options include:

OPTION	DESCRIPTION
1.33x	For lens that horizontally squeeze the image by 1.33x
1.5x	For lens that horizontally squeeze the image by 1.5.
2x	For lens that horizontally squeeze the image by 2.

5. Set the Anamorphic Display, based on how you want to view the decompressed image. This setting does not impact how the image is recorded. Options include:

OPTION	DESCRIPTION
Full	Displays the full decompressed image. Some "letter-boxing" may occur.
2.39:1	Displays the decompressed image at the SMPTE ratio of 2.39:1. Letter-boxing and/or cropping may occur.

6. Set Anamorphic Desqueeze to On. This feature is set to Off by default.

Using Markers

Guide markers are used to help frame and compose shots and define safe areas. The PIX-E monitors feature three different types of markers: frame, grid, and a center indicator.

The center indicator may be a dot or a cross, or both, and is used to mark the center point of a shot.

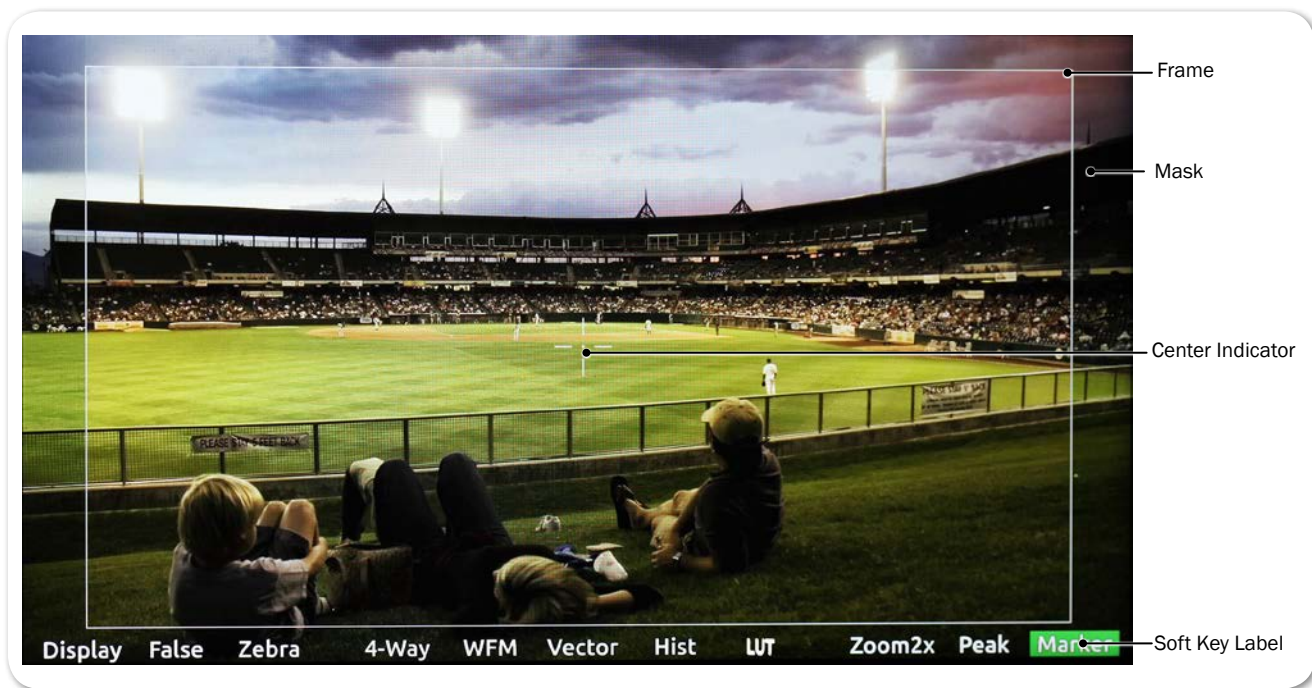

A frame marker is a thinly lined rectangle used to “frame” the shot. The frame may be customized to match the aspect ratio of the video, such as 16:9 for high-definition television. The area within the rectangular frame is safely “inside” the shot; the area outside the rectangle is the mask, which is considered “outside” the shot. There are two frame markers available on the monitor, which may be configured separately.

A grid marker divides up the frame into thirds or quarters, forming a grid pattern.

To show or hide markers:

- ▶ Press the Marker soft key button, which toggles the display of markers on or off. The Marker soft key label appears with a green background when markers are displayed.
- ① *Turning off all individual markers via their respective settings disables the Marker soft key button.*

With Markers enabled, all markers that are turned on will be visible in the video monitor. Each type of marker is enabled via its respective settings section.

To adjust marker settings:

1. Press and hold the Marker soft key button. The Marker menu appears superimposed over the lower portion of the screen.
2. Do one of the following:
 - ▶ Use the touch screen to view and change settings.
 - ▶ Turn and press the Control knob to select and change settings.

Markers have three main settings—Frame 1, Frame 2, and Center & Grid, each with its own sub-settings and options.



Frame 1 and Frame 2 have identical sub-settings—Display, Size, Color, Position, and Mask See-Thru—as described in the following table:

SETTING	SUB-SETTING	DESCRIPTION	OPTIONS
Frame 1 / Frame 2	Display	Use this setting to adjust the marker's aspect ratio.	<ul style="list-style-type: none"> • Off • 17x9 • 16x9 • 14x9 • 4x3 • 1.85:1 • 2.4:1 • Custom Aspect
	Size	Use this setting to adjust the percentage of the screen making up the inside area of the frame. For instance, if set to 90%, then the rectangular frame will make up 90% of the screen, while 10% will be masked out around the outer perimeter.	<ul style="list-style-type: none"> • 1% - 100%
	Color	Use this setting to adjust the color of the rectangular line forming the frame.	<ul style="list-style-type: none"> • White • Light Gray • Gray • Dark Gray • Black • Red • Green • Blue

SETTING	SUB-SETTING	DESCRIPTION	OPTIONS
	Position	Use this setting to position the frame on the screen.	<ul style="list-style-type: none"> Centered Top Custom Position
	Mask See-Thru	Use this setting to adjust the opacity of the masked area outside the rectangular frame. Set to 0% for fully opaque and 100% for full transparency.	<ul style="list-style-type: none"> 0% - 100%
Center & Grid	Center	Use this setting to enable the display of a cross and/or dot, superimposed at the center point of the video image.	<ul style="list-style-type: none"> Off Cross Dot Cross+Dot
	Center Color	Use this setting to adjust the color of the cross and/or dot, if used.	<ul style="list-style-type: none"> White Light Gray Gray Dark Gray Black Red Green Blue
	Grid	Use this setting to enable the display of a grid marker pattern of lines, superimposed over the video image. If set to 1/3, the screen is divided into a grid of 9 squares. If set to 1/4, the screen is divided into a grid of 12 squares. <i>ⓘ The grid, if enabled, will only appear within Frame 1. Grid markers do not apply to Frame 2.</i>	<ul style="list-style-type: none"> Off 1/3 1/4
	Grid Color	Use this setting to adjust the color of the grid lines if that marker pattern is used.	<ul style="list-style-type: none"> White Light Gray Gray Dark Gray Black Red Green Blue

Resetting Monitor Defaults

Restoring factory defaults via the Main menu resets all settings for all features on the monitor, but settings can be reset on an individual basis.

To restore a setting to factory default:

1. Open the soft key menu and navigate to view the setting you want to reset.
2. Press and hold the ALT button, while pushing in the Control knob.

This only resets one setting at a time, and not all settings available in the menu.

Storage

The PIX-E monitors can accept a SpeedDrive and a high-capacity SD memory card.

Both media can be easily removed from the monitor and inserted into standard USB or SD ports on computers, making the transfer of files easy and efficient.

PIX-E recorders format and write to an exFAT file system. The exFAT file system is readable and writable by all current major operating systems.

① *A list of storage devices approved for use with PIX-E monitors is available at: www.videodevices.com/approved*

Topics in this section include:

- ▶ SpeedDrive
- ▶ SD Memory Card
- ▶ Metadata and File Name Format
 - ▶ File Name Formats
- ▶ Formatting Storage Drives
- ▶ Working with Files
 - ▶ Deleting Recorded Files
 - ▶ Transferring Files from SpeedDrive
 - ▶ Transferring Files from SD Card

SpeedDrive

PIX-E monitors write H.264 or Apple ProRes video files to SpeedDrive™ media. The SpeedDrive is a portable enclosure for a Mini-SATA (mSATA) drive with a USB 3.0 interface. The SpeedDrive ships with a 240GB mSATA drive installed or as an enclosure only.

ProRes 4k video recording produces an extremely high data rate which produces quite a bit of heat no matter what recording medium. The SpeedDrive enclosure is expressly designed to wick the heat away from the SSD via its thermally conductive gap-pad and heat sink. Though the SpeedDrive can be very warm to the touch, this is by design to keep the SSD as cool as possible. The PIX-E monitors will display an alert if the mSATA drive (inside the SpeedDrive) is approaching maximum operating temperatures due to operating in very hot environments.

To attach a SpeedDrive to the monitor:

1. Place the SpeedDrive so that the USB plug lines up to the USB connector on the back of the monitor.
2. Depress the spring-loaded retainer clip, located at the back edge of the monitor's top panel. Only one of two clips is used to hold the SpeedDrive, and it is la-

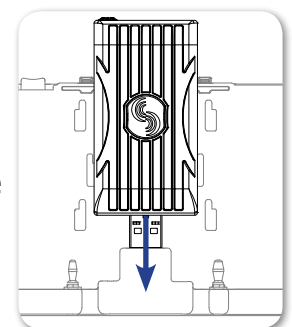

SEE DEMO VIDEO

beled SSD.

- Slide the SpeedDrive into the USB connector.

The retainer clip will spring into the notch on the SpeedDrive with a click, indicating the SpeedDrive is securely attached to the monitor.

The SpeedDrive will then be available on the PIX-E interface and appear as Drive 1 (D1) on the information bar.

- ① *A SpeedDrive may also be used to upload custom LUTs. Before using a SpeedDrive, it must be formatted by the monitor. For more information, see [Formatting Storage Drives](#).*

To remove a SpeedDrive:

- Depress the left retainer clip, labeled SSD, holding the SpeedDrive in place.
- Carefully slide the SpeedDrive out of the USB connector.

SD Memory Card

While recording ProRes or H.264 to the SpeedDrive, PIX-E monitors can also simultaneously record H.264 video files to a Secure Digital (SD) flash memory card.

An SD card may also be used to upload custom LUTs as well as save monitor settings for later recall.

The monitors accept these cards:

- Standard-capacity (SDSC: 1MB - 2 or 4GB)
- High-capacity (SDHC: 2GB - 32GB)
- Extended-capacity (SDXC: 32GB - 2TB)

To install the SD card:

- Slide the SD card into the SD Memory Card slot on the right panel of the monitor.

The SD card will then be available on the PIX-E interface and appear as Drive 2 (D2) on the information bar.

- ① *Before using an SD card, it must be formatted by the monitor. For more information, see [Formatting Storage Drives](#).*

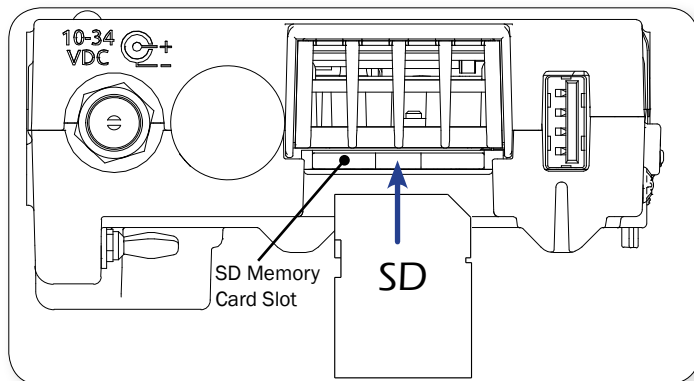

Metadata and File Name Format

The monitor lets the user enter scene, take, camera ID, reel, and clip information. Files generated by the monitor are named according to this information, making it easy for post production to identify recordings. These metadata options are located in the Metadata section of the Main menu.

To view or modify Metadata settings:

1. Press the MENU button.
2. Select Metadata.
3. Use the touch screen or Control knob to select and modify the settings as needed.

SETTING	DESCRIPTION	OPTIONS
Scene/Shot	Accepts alphanumeric values. Use this metadata field to indicate a descriptive name for the current scene or shot. A change to the Scene/Shot value will automatically reset the Take value to 1.	<ul style="list-style-type: none"> • Text entry
Take	Sets numeric values only. Use this metadata field to indicate what take number the clip is, relative to the scene. This field can be set manually and will increment each time a new file is recorded. A change to the Scene/Shot value will reset Take to 1.	<ul style="list-style-type: none"> • 1-999
CamID	Sets a single alpha character (A - Z). Use this metadata field to indicate which physical camera, in a multi-cam production, shot the content for the take.	<ul style="list-style-type: none"> • A-Z
Reel	Accepts alphanumeric values. Use this metadata field to indicate what reel the recording is part of; a reel is a container for all assets generated during a recording session or day's work. A change to the Reel value will reset the Clip value to 1.	<ul style="list-style-type: none"> • Text entry
Clip	Accepts numeric values (1-999). Use this metadata field to indicate what clip number the recording is. This field can be set manually and will increment each time a new file is recorded. A change to the Reel value will reset Clip to 1.	<ul style="list-style-type: none"> • 1-999
File Name Format	Use this field to set the naming format for files. For more information, see "File Name Formats" on page 50.	<ul style="list-style-type: none"> • Drive-Reel-Clip • Reel-Clip • CamID-Reel-Clip • Reel-Scene-Take • Scene-Take

File Name Formats

Files are named according to the File Name Format setting, accessed via Main menu > Metadata. Format options for file names includes various combinations of the metadata fields: CamID, Reel, Scene/Shot, Take, and Clip. These descriptive file name formats make it easy to identify recordings when imported into a nonlinear editor.

Formatting Storage Drives

Before using SD and SpeedDrive media, they must be formatted with the monitor.

① *PIX-E monitors over-provision drive space by 10%.*

To erase/re-format a drive:

1. Connect the drive to be formatted.
2. Press the MENU button to view the Main menu.
3. Turn and press the Control knob to select Recorder & Drives > Erase/Re-format Drive.
4. Turn and press the Control knob to select the sub-option associated with the drive for formatting. Sub-options include: SpeedDrive, SD Card, or Both drives.
5. A cautionary confirmation dialog will appear on screen asking if you want to continue. Select Yes to continue. An on-screen keyboard appears.
6. Either accept the default volume name (PIX-E) or use the keyboard to enter a new volume name.
7. Select OK to continue.

Working with Files

Files recorded on the monitor are compiled in either the SpeedDrive File List or the SD Card File List, as a list of clips arranged chronologically. The total size (in GB), created date / time, and duration of each file is provided in the list.

SpeedDrive File List

Name	Size	Date	Duration
PIX-E-001-004.mov	0.22 GB	Today, 7:50AM	00:00:13
PIX-E-001-003.mov	0.42 GB	Today, 7:49AM	00:00:34
PIX-E-001-002.mov	0.20 GB	Today, 7:22AM	00:00:10
PIX-E-001-001.mov	0.43 GB	Today, 7:09AM	00:00:44

Play

For more information, see [Viewing the File Lists](#).

To view recorded video files:

1. Press the Files soft key button.
2. Do either of the following:
 - ▶ Use the Control knob to scroll down through the displayed list.
 - ▶ Use the Control knob to scroll up and switch lists. The SpeedDrive File List screen header changes to a View SD Card button. Press in the knob to view the alternative file list.

View SD Card

Name	Size	Date	Duration
Scene 1-079.mov	0.28 GB	Today, 11:12AM	00:00:17
Scene 1-077.mp4	0.01 GB	Today, 11:10AM	00:00:08
PIX-E-001-001.mov	0.15 GB	Today, 6:06AM	00:00:10
PIX-E-001-010.mp4	0.01 GB	Today, 5:06AM	00:00:09

Play

3. Do any of the following:
 - ▶ With an MOV file highlighted, press Play to begin playback of the video.

① *Playback of H.264 files is not supported.*

▶ With any file highlighted, press the Control knob to view its details.

Details provided for each file (if available) are:

- Start Timecode
- Duration
- Created
- Frame rate & Resolution
- Codec
- Audio Format
- Timecode FPS
- User bits
- File size

Deleting Recorded Files

Recorded files may be deleted from either the SpeedDrive or SD card. Deleted files are permanently removed from the drive and cannot be restored.

To delete a file:

1. Press the Files soft key button.
2. Turn the Control knob to navigate down the Speed Drive File List or scroll up to switch to the SD Card File List.
3. Press in the Control knob to select the file you want to delete.
4. Select Delete. An important message appears prompting for confirmation.
5. Select OK to permanently delete the file.
Choosing Cancel exits without file deletion.

Transferring Files from SpeedDrive

Recorded files—MP4 or MOV—on the SpeedDrive may be copied to a computer. All QuickTime MOV files recorded with PIX-E monitors are edit-ready and compatible with post-production editing suites, such as Avid, FinalCut Pro, and Adobe Premier Pro.

To transfer files from the SpeedDrive:

1. Remove the SpeedDrive from the monitor.
2. Insert the SpeedDrive into a USB 3.0 compatible port on the computer.
3. Copy the files to the computer.

Sound Devices, LLC recommends first copying files from the storage device to the computer and then editing the copied files.

⚠ *To prevent fragmentation, do not copy video files from a computer (or any other host device) to a SpeedDrive intended to be used by the PIX-E monitor. If this occurs, it is advisable to re-format the drive with the monitor before making new recordings.*

Transferring Files from SD Card

MP4 files on an SD card may be copied to a computer for upload to a cloud, emailing, web-streaming, and so forth.

To transfer files from an SD card:

1. Remove the SD card from the monitor.
2. Insert the card into a compatible port or card reader attached to the computer.
3. Copy the files to the computer.

⚠ *To prevent fragmentation, do not copy video files from a computer (or any other host device) to an SD card intended to be used by the PIX-E monitor. If this occurs, it is advisable to re-format the card with the monitor before making new recordings.*



Recording and Playback

Although the PIX-E5 and PIX-E5H are powerful camera-mount monitors, they also have fully integrated recording capabilities.

Both can simultaneously record Apple ProRes and H.264 files, as well as play back recorded ProRes files from a SpeedDrive.

① *Sound Devices recommends the camera's output be set to required frame resolution and rate before connecting the camera to the PIX-E monitor.*

Topics in this section include:

- ▶ **Overview**
- ▶ **Record and Playback Icons**
- ▶ **Recording**
 - ▶ Choosing a Video Input Source
 - ▶ Setting up a Record Trigger
 - ▶ Video Codecs: ProRes and H.264
 - ▶ Setting PsF Options
 - ▶ Using 3:2 Pulldown Removal
 - ▶ FileSafe
 - ▶ Viewing the File Lists
- ▶ **Setting Cue Markers**
- ▶ **Playing Back Recorded Files**
 - ▶ Setting the Playback Mode
 - ▶ Using Fast Forward and Rewind
 - ▶ Jogging and Shuttling
 - ▶ Looping Playback
- ▶ **Using the Play List**

Overview

Recording and playback features are controlled from soft key buttons, above which are soft key labels indicating the button's current functionality.

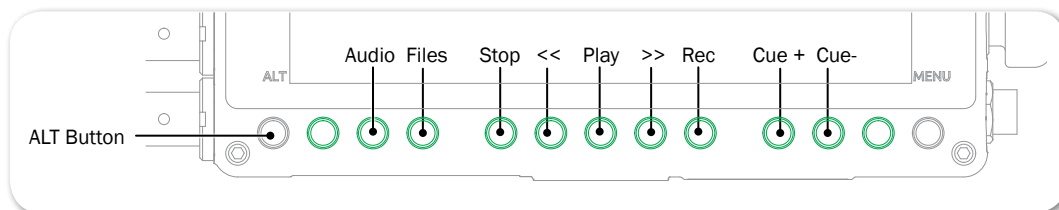







① *If the record functionality of soft keys is not displayed, press the ALT button. For more information, see [Toggling Soft Key Button Functionality](#).*

When a recording or playback functionality is activated, the label above the corresponding button appears with a colored background: yellow for stop, blue for rewind or fast forward, green for play or pause, and red for record. When fast forwarding or rewinding, the label also changes to indicate speed, such as 2x or 16x.

① *For more information about using the Audio soft key, see [Using the Audio Screen](#). For more information about using the Files soft key, see [Viewing the File Lists](#). For more information about the Cue + / - soft keys, see [Setting Cue Markers](#).*

Record and Playback Icons

The information bar at the top of the screen displays various information related to the recording process, such as timecode and file names, but it also displays transport status icons. The following table provides a quick reference to these icons.

ICON	STATUS	DESCRIPTION
	Record	The red circle icon is displayed when recording is in progress.
	Stop	The yellow square icon is displayed when recording or playback is stopped.
	Play	The green arrow icon is displayed when playback is in progress.
	Fast Forward	Double arrows, facing right, is the icon displayed when fast forwarding is in progress.
	Rewind	Double arrows, facing left, is the icon displayed when rewinding is in progress.
	Pause	The green pipes icon flashes when playback is paused.

Recording

The PIX-E5 accepts SDI or HDMI signals, and the PIX-E5H accepts only an HDMI signal. Both can record Apple ProRes QuickTime (MOV) and H.264 (MP4) files to a SpeedDrive. Both monitors are also capable of simultaneous dual-codec recording, whereby one primary codec is recorded to the SpeedDrive while H.264 is recorded to an SD card.

For more information, see [Selecting a Video Codec](#) and [Enabling Simultaneous Dual-Codec Recording](#). SpeedDrives and SD cards must be formatted by the PIX-E monitor. For formatting instructions, see [Formatting Storage Drives](#).

To start recording:

- ▶ Press the Rec soft key button.

① *If the transport controls (REC, STOP, PLAY) are not visible, press ALT to switch the soft key buttons to their alternative transport functionality.*

While recording, the OSD will change to indicate recording activity:

- Absolute Time display is red
- Timecode display is red
- Filename display is red
- Red circle icon appears on information bar
- Rec soft key label's background is red
- Drive status (D1 & D2) displays are amber

Also, the LED on the SpeedDrive illuminates amber when the drive is accessed by the monitor.

⚠ ***Do not remove the SpeedDrive while its LED is illuminated.***

To stop recording:

- ▶ Press the Stop soft key button.

When stopped, the Stop soft key label's background is yellow, and a yellow square icon appears in the top left of the information bar.

Choosing a Video Input Source

Selecting which input to use as the video input source is an option on the PIX-E5, since the PIX-E5 features both HDMI and SDI inputs.

To select SDI or HDMI input:

1. Press the MENU button.
2. Select Video I/O > Video Input.
3. Select SDI or HDMI.

① *A best practice tip is to disconnect and reconnect the video input cables whenever changes are made to the input source.*

Setting up a Record Trigger

The monitor will begin recording when the Rec soft key button is pressed, but it can also start and stop recording automatically when it detects a record trigger from a camera.

To set a record trigger:

1. Press the MENU button to access the Main menu.
2. Select Recorder & Drives > Rec Trigger.
3. Select a record trigger.

SETTING	DESCRIPTION
REC button only	Default setting. Record only begins when the Rec soft key is pressed.
Timecode	Recording begins when running timecode is sensed. Recording is stopped when stationary timecode is sensed or timecode is no longer present.
HDMI/SDI Flag - Sony	Various camera manufacturers can trigger recording by sending a specific flag in the HDMI or SDI signal when the camera is put into record.
HDMI/SDI Flag - Canon	
HDMI/SDI Flag - Panasonic	
SDI Flag - Panasonic (Varicam)	If you want to trigger, via video signal, the PIX-E5 or PIX-E5H to record when a camera records, select the option that corresponds to the camera in use.
SDI Flag - Arri	
SDI Flag - RED	
SDI Flag - PIX	

Video Codecs: ProRes and H.264

The PIX-E5 records ProRes video at the same resolution and frame rate as the incoming video signal. Six versions of the ProRes codec are available, ranging from the highest quality ProRes 4444 XQ (12 bit), to the most data-efficient ProRes 422 Proxy (10 bit).

The PIX-E5H records four of the available codecs: ProRes 422 HQ (10 bit), ProRes 422 (10 bit), ProRes 422 LT (10 bit), and ProRes 422 Proxy. Unlike the PIX-E5, the PIX-E5H does not record ProRes 4444 XQ and ProRes 4444.

① *To record using the ProRes 4444 XQ codec, the PIX-E5 must detect a Log-encoded signal, such as Sony S-log2, over SDI. This is an Apple® requirement. Some cameras do not flag that they are outputting log-encoded signal in their SDI output.*

Both models are also capable of recording the H.264 codec, which offers a good balance between compression & quality to reach low data rates and small file sizes, perfect for web streaming, email, and faster file uploads.

Like ProRes, H.264 may be recorded to the SpeedDrive, if chosen as the primary codec. Otherwise, the PIX-E monitor have a dual-codec recording capability, where ProRes is recorded to the SpeedDrive and H.264 is simultaneously recorded to an SD card. While recording 4K in ProRes, the monitor will automatically scale the 4K signal to 1080p for recording H.264, thereby reducing its file size even further.

If a LUT is active, it will be baked into the recorded H.264 file, but will not impact ProRes recordings. This is ideal for simultaneously recording a full dynamic range, log-encoded ProRes master file for the edit suite and a REC709 H.264 file suitable for normal viewing.

The following table shows which codecs get recorded to SpeedDrive versus SD card:

SPEEDDRIVE	SD CARD
ProRes (from Proxy up to 4444 XQ)	H.264
H.264	

Selecting a Video Codec

The primary codec is used for files recorded to the SpeedDrive.

To select a primary codec:

1. Press the MENU button.
2. Select Recorder & Drives > Codec.
3. Select a codec.

① *If the connected video signal is not 4:4:4, the PIX-E5 will prevent selection of ProRes 4444 XQ and ProRes 444 codecs. If those codecs are already chosen and a*

4:2:2 video signal is connected, the PIX-E5 automatically adjusts codec selection to ProRes 422 HQ.

Also, due to processing requirements, if H.264 is selected, the HDMI out, scopes and 4-Way view are disabled during recording.

If H.264 is chosen as the primary codec, it will be recorded to the SpeedDrive. When only recording H.264 to an SD Card, the primary codec setting should be turned off.

To turn off recording of primary codec to a SpeedDrive:

1. Press the MENU button.
2. Select Recorder & Drives > Codec > Off.

Enabling Simultaneous Dual-Codec Recording

While recording a ProRes codec (in MOV file format) to the SpeedDrive, the monitor can simultaneously record H.264 (in MP4 file format) to an SD card, which is ideal as an economical, low bit-rate handoff.

The SpeedDrive status appears as D1 on the information bar, while status for the SD card appears as D2.

Both recordings will also include audio—up to eight channels with ProRes and two channels with H.264, as well as timecode stamps.

① *ProRes and H.264 files may not start/stop at exactly the same TC value; however, corresponding frames on the ProRes and H.264 files will have the exact same TC value.*

By default, dual-codec recording is off.

To enable dual-codec recording:

1. Press the MENU button.
2. Select Recorder & Drives.
3. Set SD Card H.264 Recording to On.

① *If set to record H.264, then HDMI out, scopes, and 4-way view are disabled during record.*

Understanding Recording/Drive Error Messages

The PIX-E monitors will display messages whenever there is an issue related to the chosen codec(s), what drives are available and whether a video signal is detected. This table explains some messages that might appear along with how to easily resolve the issue.

MESSAGE	PROBLEM	HOW TO RESOLVE
No Recording Drive Present	There is neither a SpeedDrive mounted nor an SD card inserted into the monitor.	Mount a SpeedDrive and/or insert an SD card.
No SpeedDrive Present	The primary codec is set to something other than Off, and there is no SpeedDrive mounted to the monitor.	Either mount a SpeedDrive if one is not present, check to ensure a proper mount if one is present, or turn off recording to the SpeedDrive so that only the SD card will be used. (MENU > Recorder & Drives > Codec)
No SD Card Present	SD Card H.264 Recording is set to On, but there is no SD card inserted into the monitor.	Either insert an SD card or turn off recording to the SD card.
SD Card Locked	SD Card H.264 Recording is set to On, but the SD card in the monitor is locked, preventing the monitor from being able to record to the card.	Insert a different, unlocked SD card, or remove, unlock, and reinsert the current SD card.
Video Input Missing	Cannot record because no video input is detected.	Check the connection of HDMI or SDI cables between the video source and the monitor's HDMI or SDI inputs. Also ensure the Video Input setting is configured properly.

Setting PsF Options

Some cameras output signal as progressive segmented frames (PsF). PsF is a method for transmitting progressive content as an interlaced signal. This is useful for playing progressive video on older monitors that do not support 1080 progressive.

PsF signal is identical to interlaced signal in that each frame consists of two fields with one field representing the odd lines of the frame, and the other field representing even lines of the frame. PsF signal differs from interlaced signal in that the two fields are captured at the same moment in time; therefore, there are no interlaced motion artifacts.

By default, if SDI input signal is flagged as PsF, the PIX-E5 will sense this automatically and convert the signal to progressive for display on the monitor. If the 1080i signal from SDI is not flagged as PsF, or if the signal is sent via HDMI, the monitor may be set to interpret the 1080i signal as PsF so that it can convert the signal to progressive.

To interpret 1080i signal as PsF:

1. Press the MENU button.
2. Select Video I/O > Input PsF Detect.
3. Select Interpret 1080i as PsF.

By default, the monitor will record PsF signal as PsF to the file. If PsF-to-progressive conversion is required, the PIX-E5 or PIX-E5H must be set to convert this signal.

To record PsF input signal as progressive:

1. Press the MENU button.
2. Select Video I/O > Input to File Conversion. By default, this is set to Same as Video Input.
3. Select PsF to P.

Using 3:2 Pulldown Removal

When Input to File Conversion is set to 3:2 Pulldown, the PIX-E recording monitor will automatically apply 3:2 pulldown if it detects a 3:2 cadence in an incoming 1080i 59.94 signal or 1080 PsF 29.97 signal. This will result in a 1080p 23.98 recording. If no such cadence is detected, the recording will remain as 1080i 59.94 or 1080 PsF 29.97.

When pulldown is detected, the 'In' field in the Information bar will display (3:2) after the file res/rate.

To use 3:2 pulldown for file conversion:

1. Press the MENU button.
2. Select Video I/O > Input to File Conversion. By default, this is set to Same as Video Input.
3. Select the 3:2 Pulldown option.

FileSafe

The PIX-E monitors feature FileSafe™ file-protection. During recording, the monitor writes to a temporary file format with the extension .SDV. When recording is stopped, the file is "finalized" to a standard Quicktime (.MOV) file. The temporary .SDV file format allows for reliable recovery of content in situations where power is lost or a drive is removed during recording. Upon powering up, the monitor will search for any .SDV files on all drives and finalize them to the standard .MOV file format.

① *Using the FileSafe utility, a free download from the Video Devices website, .SDV files can also be recovered to .MOV files from a Mac or Windows computer.*

Viewing the File Lists

A list of recorded files is available via the SpeedDrive File List screen. The list provides each file's name, size, the date and time each file was recorded, and each video file's duration.

To view the SpeedDrive File List:

- ▶ Press the Files soft key button.

The SpeedDrive File List appears, showing a list of recorded files on the drive and related information, such as file size and duration.

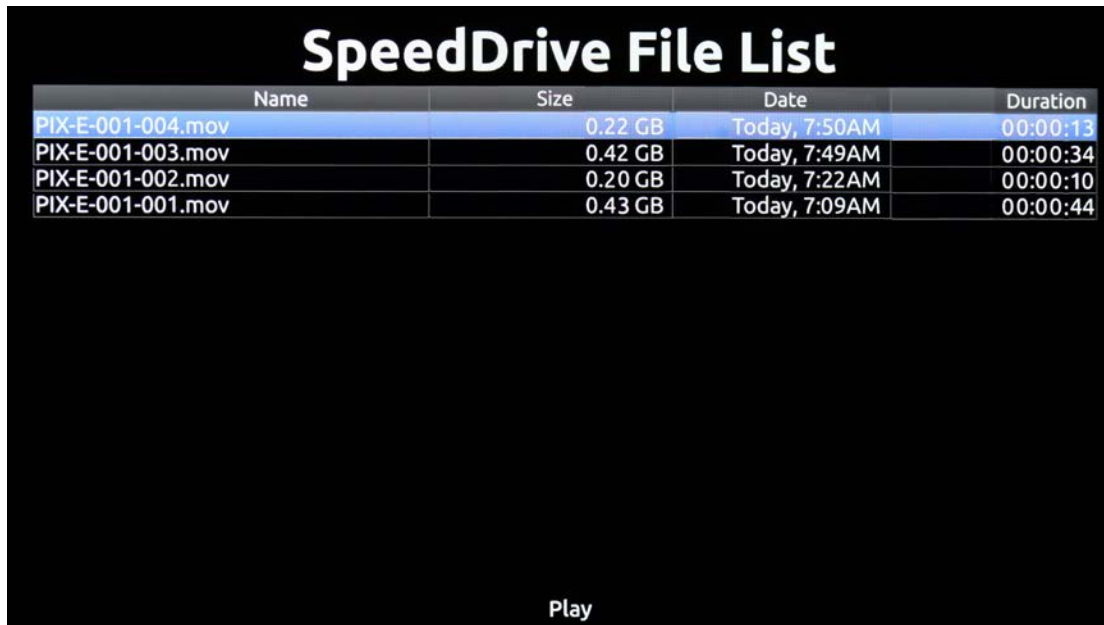

Name	Size	Date	Duration
PIX-E-001-004.mov	0.22 GB	Today, 7:50AM	00:00:13
PIX-E-001-003.mov	0.42 GB	Today, 7:49AM	00:00:34
PIX-E-001-002.mov	0.20 GB	Today, 7:22AM	00:00:10
PIX-E-001-001.mov	0.43 GB	Today, 7:09AM	00:00:44

Play

- ① *The SpeedDrive File List screen is not accessible during playback or while recording.*

The monitor also has an SD Card File List for displaying a list of H.264 (MP4) files recorded to the SD card.

To view the SD Card File List:

1. Press the Files soft key button. The SpeedDrive File List appears.
2. Turn the Control knob to scroll up. The SpeedDrive File List screen header changes to a View SD Card button.

View SD Card

Name	Size	Date	Duration
Scene 1-079.mov	0.28 GB	Today, 11:12AM	00:00:17
Scene 1-077.mp4	0.01 GB	Today, 11:10AM	00:00:08
PIX-E-001-001.mov	0.15 GB	Today, 6:06AM	00:00:10
PIX-E-001-010.mp4	0.01 GB	Today, 5:06AM	00:00:09

Play

- Push in the Control knob to select the View SD Card button. The alternative SD Card File List screen appears.

SD Card File List

Name	Size	Date	Duration
PIX-E-001-086.mp4	0.00 GB	Today, 5:01PM	00:00:18
PIX-E-001-085.mp4	0.01 GB	Today, 4:57PM	00:00:12
PIX-E-001-084.mp4	0.02 GB	Today, 4:56PM	00:00:08
PIX-E-001-083.mp4	0.06 GB	Today, 4:49PM	00:00:35
PIX-E-001-082.mp4	0.02 GB	Today, 4:48PM	00:00:11
PIX-E-001-081.mp4	0.02 GB	Today, 4:47PM	00:00:12
PIX-E-001-080.mp4	0.13 GB	Today, 4:46PM	00:00:16
PIX-E-001-079.mp4	0.05 GB	Today, 4:45PM	00:00:10

Play

- Repeat the procedure to switch back to the SpeedDrive File List screen.

Setting Cue Markers

Cue markers may be set while recording or during playback. Cue markers make it easier to navigate within a recording. When each cue is set, it is given a numerical value beginning with one (1). The current cue is also displayed on screen in the information bar.

To set a cue marker:

► During recording or playback, press the Cue + soft key button.

① *If a keyboard is attached, Ctrl+Q will add a cue marker.*

To remove a cue marker:

1. During recording or playback, press the Cue - soft key button to remove the current cue.
2. When the confirmation dialog box appears, select OK to remove the cue marker.

① *If a keyboard is attached, Ctrl+Shift+Q will delete the current cue marker.*

Playing Back Recorded Files

The PIX-E monitor can playback ProRes (MOV) video files that it has recorded. During playback, video is shown on screen and also sent to the monitor's video output(s). The audio signal is also sent to the video output(s) as well as the headphone output.

① *The monitor cannot playback H.264 (MP4) files. To play such files, transfer the files to a computer and use any H.264/MP4-compatible playback application.*

To play the last file recorded:

► Press the Play soft key button.

① *By default, playback will stop at the end of the file. Alternative playback behaviors may be configured via the Playback mode. For more information, see [Setting the Playback Mode](#).*

To play another recorded file:

1. From Stop, press the Rewind (<<) or Fast Forward (>>) soft key buttons to select a file, as indicated by the file names that appear in the information bar at the top of the on-screen display (OSD).
2. Press the Play soft key button.

To play a recorded file from the SpeedDrive File List:

1. Press the Files soft key button. The SpeedDrive File List appears.
2. Select a file.
3. Press the Play soft key button.

During playback, the OSD will change to indicate playback activity:

- Absolute Time display is green
- Timecode display is green
- Filename display is green
- Green arrow icon appears on information bar
- Play soft key label's background is green
- D1 drive status display is amber

① *Files may be added to a play list for sequential playback. See [Using the Play List](#) for more information. Also, recorded files may be deleted from the SpeedDrive or SD card. For more information, see [Deleting Recorded Files](#).*

To pause playback:

- ▶ Press the Play soft key button again while playback is in progress.
When playback is paused, the Play soft key label shows the word Pause, its green background flashes, and a green pipes icon flashes on the information bar.
- ▶ Press the Play soft key button resume playback.

Setting the Playback Mode

The Playback mode determines the way in which files are played. For instance, pressing Play could play a chosen file once before stopping or perhaps pausing on the last frame. Playback could also be set to play all files in the file list, one after another, or even playing back files from a play list. Looped playback is another option.

To set the Playback mode:

1. Press the MENU button.
2. Select System > Playback Mode.
3. Select an option.

MODE	DESCRIPTION
Play Once	Default setting. Playback will stop when the end of the file is reached.
Play Once - Paused	Playback will pause on the last frame when the end of the file is reached.
Play All	Playback will play each file from the file list in order, one after another, until there are no more files left in the file list to play.

MODE	DESCRIPTION
Play All - Pause	When playback reaches the end of the first file, the next file in the file list is cued on the first frame, and playback is paused.
Play All - Loop	Playback will play each file in order, one after another, and when the end of the last listed file is reached, play will loop back to the first file and continue.
Play List	Playback will play each file from a play list in order, one after another, until there are no more files left in the play list to play.
Play List - Pause	When playback reaches the end of a file, if it is in a play list, the next file in that play list is cued on the first frame, and playback is paused. If the file is not in a play list, when the end of the file is reached, playback is stopped.
Play List - Loop	Playback will play each file in order, one after another, and when the end of the last file is reached, play will loop back to the first file in the play list and continue.

① *Looping a single playing file and looping between cue markers are also possible. For more information, see [Looping Playback](#).*

Using Fast Forward and Rewind

During playback, you may fast forward or rewind at 2x or 16x normal speed.

To rewind or fast forward playback:

1. Press PLAY to begin playback.
2. Do either of the following:
 - ▶ Press and hold the Rewind (<<) soft key button. Rewind will begin at 2x speed. After five seconds, rewind accelerates to 16x speed.
 - ▶ Press and hold the Fast Forward (>>) soft key button. Fast forward will begin at 2x speed. After five seconds, it accelerates to 16x speed.

The Fast Forward and Rewind soft key buttons may also be used to quickly jump to previous or next cue markers. This may be done during playback or while playback is paused.

To jump to cues, do either of the following:

- ▶ Quickly press and release Fast Forward (>>) to jump to the next cue in the file.
- ▶ Quickly press and release the Rewind (<<) to jump back to the previous cue in the file.

Jogging and Shuttling

The PIX-E monitor also provides the ability to jog frame by frame through recorded video, or shuttle in slow or fast motion.

To jog frame by frame:

1. Press PAUSE to pause playback.
2. Do either of the following:
 - ▶ Turn the Control knob counter-clockwise to jog backwards.
 - ▶ Turn the Control knob clockwise to jog forwards.

To shuttle through a playback:

1. Press PLAY to begin playback, or PAUSE to pause playback.
2. Push in the Control knob to enter Shuttle mode.
3. Do either of the following:
 - ▶ Turn the Control knob counter-clockwise to shuttle backwards at rates from 1/8x to 32x speed.
 - ▶ Turn the Control knob clockwise to shuttle forwards at rates from 1/8x to 32x speed.

The shuttling speed appears as a blue label above the Rewind or Fast Forward soft key buttons, depending on the direction. The following example shows the forward shuttle of 1/2 the normal speed.

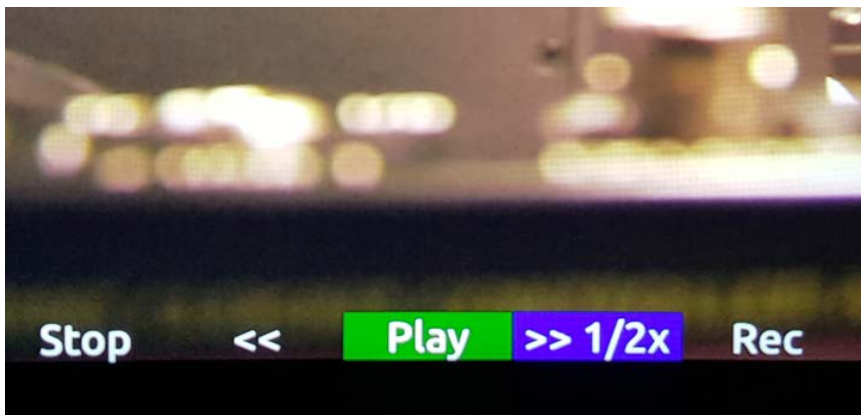

Audio scrub remains available while shuttling in a forward direction from 1/8x speed up to 2x the normal speed, so audio can still be monitored. Audio will change in pitch according to the shuttle speed.



Looping Playback

Looping playback may be enabled between consecutive cue points or the beginning and end of the current playing file.

To loop a playing file from start to end, do either of the following:

- ▶ Hold the Play soft key button in for one second.
- ▶ Press Ctrl+L on an attached keyboard.

While looping, LOOP will appear on screen in the information bar. The looped file will replay from the beginning after it reaches the end of the file.

① *Repeat either of the previous steps to toggle off looped playback of the file.*

To loop playback between cues in a file:

- ▶ While playback is in between the two cue points, hold in the Play soft key button and press Fast Forward (>>).

While looping between cues, the cue marker numbers will appear on screen in the information bar. Square brackets are used for the start and end of the file. For instance, a file has three cue markers when looping playback is begun. If looping between cues one and two, then 1-2 is displayed on screen. If looping between the start of the file and the first cue marker, then [-1 is shown, and if looping between the third/final cue and the end of the file itself, 3-] is displayed.

To return to loop entire file, while looping between cues:

- ▶ Hold the Play soft key button in and press Rewind (<<).

To exit looped playback completely:

- ▶ Hold the Play soft key button in for one second.

Using the Play List

Recorded MOV files may be added to the play list for sequential playback. When a file is added to the play list, a number appears beside the file's name on the SpeedDrive File List screen; this numerical value indicates where in the order the file sits in the play list. For instance, the second file added to the play list will show a 2 next to its file name.

① *To play files in the play list's order, the monitor's Playback mode must be set to one of the Play List options. For more information, see [Setting the Playback Mode](#).*

To add a file to the play list:

1. Press the Files soft key button.

2. Turn the Control knob to navigate down the SpeedDrive File List.
3. Press in the Control knob to select the file you want to add.
4. Select Add to Play List.

The file is added to the end of the play list and is assigned the next numerical value accordingly. For instance, if there are three files in the play list when another file is added, that file becomes fourth in the play list's playback order, so 4 will appear next to the file's name on the SpeedDrive File List screen.

To remove a file from the play list:

1. Press the Files soft key button.
2. Navigate down the SpeedDrive File List to the file you want to remove.
3. Press in the Control knob to select it, and then choose Remove from Play List.

Removing a file from the play list will decrease the position of all files that are numerically after the removed file in the play list. For instance, if a play list has five files and the file designated third (3) in the play list is removed, the fourth and fifth files will be renumbered to 3 and 4 respectively.

To empty the play list:

1. Press the Files soft key button.
2. Press in the Control knob to select any MOV file in the list.
3. Select Empty Play List.

Emptying the play list will clear the entire play list.

Audio

The PIX-E recording field monitors accept either two analog audio inputs or four channels of embedded audio on the HDMI input.

The PIX-E5 also accepts up to eight channels of embedded audio on the SDI input.

Topics in this section include:

- ▶ Using the Audio Screen
- ▶ Setting up Audio Input
- ▶ Setting up Tracks
- ▶ Routing Audio Output
 - ▶ Adjusting Headphone Warning Bell Level

Using the Audio Screen

The Audio screen displays the monitor's audio configuration and serves as an interface to make some changes to the audio setup.

To access the Audio screen:

- ▶ Press the Audio soft key button.

The screenshot shows the Audio screen interface. At the top left, it says "HP: 1,2". Below this is a table with columns: Arm, Name, Source, Gain, Delay, and a level meter. The level meter has markings at -50, -40, -30, -20, -18, -12, -6, and 0. The first track, Track 01, is highlighted in blue. Labels on the left side of the screen point to various elements: "Headphone source" points to the HP: 1,2 label; "Track number" points to the '1' in the first row; "Track name" points to "Track 01"; "Input source" points to "Line In 1"; "Input gain" points to "0 dB"; and "Track delay" points to "0 mS". A label "Track level meter" points to the level meter scale.

Arm	Name	Source	Gain	Delay	-50	-40	-30	-20	-18	-12	-6	0
1	Track 01	Line In 1	0 dB	0 mS								
2	Track 02	Line In 2	0 dB	0 mS								
3	Track 03	HDMI In 1	0 dB	0 mS								
4	Track 04	HDMI In 2	0 dB	0 mS								
5	Track 05	SDI In 1	0 dB	0 mS								
6	Track 06	SDI In 2	0 dB	0 mS								
7	Track 07	SDI In 3	0 dB	0 mS								
8	Track 08	SDI In 4	0 dB	0 mS								

SCREEN ELEMENT	DESCRIPTION
Track number	Displays the number of the track and a color indicating whether the track is armed. Red background: Armed track. Black background: Unarmed track.
Track name	The name of the track.
Input source	The source of the track's input.
Input gain	The input gain value in dB.
Headphone source	The source for headphone output. Left and right channels are separated by a comma. For more information on setting up headphone source, see Routing Audio Output .
Track level meter	The audio level of the track.

① *The Audio screen is not accessible during playback or while recording.*

Setting up Audio Input

The PIX-E5 can record audio from the SDI input, HDMI input, 3.5 mm stereo line input, and via XLR inputs on the optional PIX-LR accessory. The PIX-E5H does not have an SDI input, but can record audio from the HDMI input, 3.5 mm stereo line input, and XLR inputs on the PIX-LR accessory, if attached.

To set the audio input:

1. From the Audio screen, select the track to adjust.
2. Turn and press the Control knob to select the track's Source field.
3. Select the input source from the list of options, based on the following table, which provides a list of input source options available on either the PIX-E5 or PIX-E5H.

OPTIONS ON THE PIX-E5	OPTIONS ON THE PIX-E5H
Line In 1	Line In 1
Line In 2	Line In 2
XLR 1*	XLR 1*
XLR 2*	XLR 2*
SDI In 1 / HDMI In 1	HDMI In 1
SDI In 2 / HDMI In 2	HDMI In 2
SDI In 3 / HDMI In 3	HDMI In 3
SDI In 4 / HDMI In 4	HDMI In 4
SDI In 5 / HDMI In Off	Off
SDI In 6 / HDMI In Off	
SDI In 7 / HDMI In Off	
SDI In 8 / HDMI In Off	
Off	* Applies only if PIX-LR accessory is attached

① *If the audio input source is set to Line In 1 or Line In 2, and that corresponds with the Timecode mode being set to LTC Line In 1 or LTC Line In 2, respectively, then linear timecode is stamped to the audio track, and audio on the track is muted to prevent damage to a user's hearing.*

Setting up Tracks

The Audio screen provides the ability to customize track names, set gain levels, adjust input delays, and arm or disarm certain tracks. Use an input delay to align audio with delayed video output from cameras.

To arm or disarm a track:

1. From the Audio screen, select the track to adjust.
2. Turn the Control knob to highlight the track's number field.
3. Press the Control knob to select option to either arm or disarm the track.

① *Additional options include arming or disarming all tracks.*

To edit a tracks' name:

1. From the Audio screen, select the track to adjust.
2. Turn and press the Control knob to edit the track's name field.
3. Use the on-screen keyboard, or attached USB keyboard, to enter the track's new name.
4. Select OK, or press Enter on a USB keyboard, if attached.

To adjust a track's input gain:

1. From the Audio screen, select the track to adjust.
2. Turn and press the Control knob to select the track's Gain field.
3. Adjust the gain in +/- 1 dB increments from -40 dB to +20 dB as needed. The default is 0 dB.
4. Press the Control knob to exit adjustment mode.

To adjust a track's input delay:

1. From the Audio screen, select the track to adjust.
2. Turn and press the Control knob to select the input delay field.
3. Adjust the input delay in millisecond intervals.
4. Press the Control knob to exit adjustment mode.

Routing Audio Output

Audio tracks 1 through 8 are embedded in SDI and HDMI outputs. The PIX-E5H outputs audio to its HDMI output. The PIX-E5 outputs audio to both SDI and HDMI outputs.

Both models also feature a 3.5 mm headphone output. The audio source for this

output is user-definable.

To choose a headphone source:

1. Press and hold the MENU button for 1 second to access the Monitor menu.
2. Select the HP Source tab.
3. Select a headphone source.

SOURCE	DESCRIPTION
1,2	Select this stereo option for routing channel 1 to the left and 2 to the right.
3,4	Select this stereo option for routing channel 3 to the left and 4 to the right.
5,6	Select this stereo option for routing channel 5 to the left and 6 to the right.
7,8	Select this stereo option for routing channel 7 to the left and 8 to the right.
1357,2468	Select this stereo option for routing odd channels to the left and even channels to the right.
12345678	Select this mono option if you want all audio inputs routed to both sides of headphones.

- ① *When the PIX-LR is attached, the HP Source options change with the addition of some XLR options. See [Choosing a Headphone Source](#) for more information.*

To adjust headphone gain:

- ① *As a safety precaution, the touch screen is disabled to avoid sudden, accidental changes to headphone gain. Adjustments can only be made using the Control knob.*
1. Press and hold the MENU button for 1 second to access the Monitor menu.
 2. Select the HP Gain tab.
 3. Adjust the HP gain, using the Control knob.

Adjusting Headphone Warning Bell Level

A short tone is sent to the headphone output to indicate transport changes (Record start / stop and playback start / stop) or error conditions (Drive missing or drive full). The level of this tone can be adjusted.

To adjust the level of the Headphone Warning Bell:

1. Press the MENU button to access the Main menu.
2. Select Audio > HP Warning Bell Level.
3. Turn the Control knob to adjust the level (-61 to -12 dBFS).

Timecode

PIX-E monitors store timecode metadata within QuickTime files.

The timecode value that is stored is derived from the monitor's internal time-of-day clock, from its internal record run generator, or from the external video input. Linear timecode may also be stamped to an audio track via Line In.

In addition, on the PIX-E5, timecode can be outputted over SDI, which is useful for feeding external devices.

① *Because the monitor does not include an internal, jammable, free-running generator, it is recommended that the camera utilizes a suitable timecode generator for applications requiring a high level of accuracy.*

Topics in this section include:

- ▶ **Setting a Timecode Mode**
- ▶ **Toggling Drop Frame Timecode**
- ▶ **Setting the Rec Run Timecode Value**

Setting a Timecode Mode

The PIX-E5 offers several options for timecode mode, such as Time of Day, Record Run, and external timecode via SDI, HDMI, or via Line In. The PIX-E5H offers all of those as well, with one limitation being that external timecode—Ext TC mode—is via HDMI only.

To select a timecode mode:

1. Press the MENU button.
2. Select Timecode > Timecode Mode.
3. Select a timecode mode. Time of Day is the default mode.

OPTION	DESCRIPTION
Ext TC (SDI/HDMI)	Many cameras are capable of sending timecode along with video signal via SDI or HDMI. When using external timecode, any user bits present will be stamped to recorded files. This timecode can be used to trigger the monitor to begin recording. For more information, see Setting up a Record Trigger . ① <i>On the PIX-E5H, this option is called Ext TC (HDMI).</i>

OPTION	DESCRIPTION
Ext TC (Line In 1)	<p>Ext TC (Line In 1) stamps the timecode into the QuickTime files, but also linearly in the audio track if Line In 1 is selected as audio input source. When selected, audio tracks that Line In 1 are sent to are muted in the headphones to prevent damage to a user's hearing. For more information, see Setting up Audio Input.</p> <p>This timecode can be used to trigger the monitor to begin recording. For more information, see Setting up a Record Trigger.</p>
Ext TC (Line In 2)	<p>Ext TC (Line In 2) stamps the timecode into the QuickTime files, but also linearly in the audio track if Line In 2 is selected as audio input source. When selected, audio tracks that Line In 2 are sent to are muted in the headphones to prevent damage to a user's hearing. For more information, see Setting up Audio Input.</p> <p>This timecode can be used to trigger the monitor to begin recording. For more information, see Setting up a Record Trigger.</p>
<p>① <i>Ext TC Line In 1 and 2 are useful for outputting incoming TC or playback TC with the PIX-LR's XLR outputs.</i></p>	
Time of Day	<p>Time of Day timecode mode uses the monitor's internal system clock. When using Time of Day timecode mode, ensure that the system clock is set properly. For more information, see Setting the Date and Time.</p>
Record Run	<p>Record Run timecode mode sequentially stamps files with timecode based on the camera's frame rate. Each subsequent recording starts on the timecode value from where the previous recording stopped.</p>

Toggle Drop Frame Timecode

Sometimes a production requires the use of drop frame timecode, and it is necessary to ensure the monitor stamps files as drop frame accordingly.

To toggle drop frame timecode:

1. Press the MENU button.
2. Select Timecode > Drop Frame Enable.
3. Select Off or On.

Setting the Rec Run Timecode Value

Record run timecode mode stamps files sequentially, with the first file being stamped from a specified value. This value is 00:00:00:00 by default, but it can be set to any value. Every time this value is set, the next recording will begin at that value and subsequent recordings will start on the timecode value from where the previous recording stopped.

To set the record run timecode value:

1. Press the MENU button.
2. Select Timecode > Set Rec Run Value.

-
3. Turn the Control knob to set the highlighted value.
 4. Press the Control knob to move to the next value.





System Functions

The Main menu provides access to various system settings related to the date and time, as well as the ability to update firmware and view version information.

Topics in this section include:

- ▶ **Fan**
- ▶ **Time and Date**
 - ▶ Setting the Date and Time
- ▶ **Configuring the Screen Saver**
- ▶ **Updating Firmware**
- ▶ **Checking Version and Serial Number**
- ▶ **Saving and Recalling Settings**
- ▶ **Restoring Factory Default Settings**

Fan

While each monitor's chassis is made of high-strength, thermally conductive aluminum, which doubles as a heat-sink to wick away heat from internal components, the PIX-E5 and PIX E5H also feature an internal fan. This fan may be set to always run while the monitor is powered on, or it may be configured to turn off while recording.

To configure the fan:

1. Press the MENU button.
2. Select System > Fan. Options include: Always On and Off during record.

Time and Date

The monitor uses the time and date for file properties when writing files to disk. The time and date is also used by the timecode system when the Timecode Mode is set to Time of Day.

SETTING	DESCRIPTION	DEFAULT
Time Format	Selects between 12 or 24 hour format for the time-of day clock. <ul style="list-style-type: none"> • 12h • 24h 	12h
Date Format	Selects between MM/DD/YY and DD/MM/YY date format. <ul style="list-style-type: none"> • MM/DD/YY • DD/MM/YY 	MM/DD/YY
Time Zone	Select the international time zone. <ul style="list-style-type: none"> • (All international time zones) 	(GMT-06:00) Central Time (US)
Daylight Saving	Toggles daylight saving on or off for the time-of-day clock. <ul style="list-style-type: none"> • Off • On 	Off
Set Date/Time	Set the date and time.	

Setting the Date and Time

Before setting the date and time, Time Zone and Daylight Saving should be configured properly.

To select a time zone and set daylight saving:

1. Press the MENU button.
2. Select System > Time Zone.
3. Select the correct time zone for your location.
4. Select System > Daylight Saving.
5. Select On or Off.

To set the date and time:

1. Press the MENU button.
2. Select System > Set Date/Time.
3. Turn the Control knob to set the highlighted value.
4. Press the Control knob to move to the next value.

Configuring the Screen Saver

A screen saver is available to help protect the integrity of the monitor's LCD. Any tap on the touch screen or press of a button will deactivate the screen saver. Additionally, should the monitor receive a record trigger from the camera, the screen saver will also deactivate.

The screen saver is set, by default, to turn on after 30 minutes of inactivity; however, this period of inactivity used to start the screen saver is adjustable.

To configure the screen saver:

1. Press the MENU button.
2. Select System > Screen Saver. Options include: 30 Minutes, 1 Hour, or 2 Hours.

Updating Firmware

Firmware updates are released periodically to improve the functionality and add new features to the monitor. Firmware updates are performed with a .prg file obtained from the Video Devices website.

To update firmware:

1. Download the .prg file to a computer.
2. Connect an SD card or SpeedDrive to the computer.
3. Copy the .prg file to the SD card or SpeedDrive.
4. Remove the SD card or SpeedDrive from the computer and connect it to the monitor.
5. Power up the monitor.

⚠ *Ensure that the monitor is powered via the supplied PIX-E PSU and fully-charged batteries. Power loss during a firmware update can result in the monitor becoming inoperable. In the unlikely event that power is lost during a firmware update, a computer and the USB boot cable, included with the monitor, may be used to reinstall the firmware and recover operation. Contact Customer Support for proper recovery procedures.*

6. Press the MENU button.
7. Select System > Update Firmware.

The monitor will search connected drives for a .prg file. When the .prg file is found, follow the on-screen instructions to perform the firmware update.

① *Firmware updates will take several minutes to complete, and the unit will reboot multiple times during the process. Various functions and ports will become inactive while firmware is updating. The monitor is ready to use when it returns to the main display.*

8. (Optional) Verify the firmware version by pressing the MENU button and selecting System > Version Info.

Checking Version and Serial Number

For convenience and support issues, the monitor's firmware version and serial number can be viewed from the Main menu.

To check the firmware version and serial number:

1. Press the MENU button.
2. Select System > Version Info.

A dialog with information is displayed, including the firmware version on the first line and the monitor's serial number at the bottom.

Saving and Recalling Settings

All settings on the monitor can be stored for easy recall at a later time. This is useful for recalling settings for different work flows or projects, or when setting up multiple PIX-E monitors with the same settings.

To save settings to SD card or SpeedDrive:

1. Press the MENU button.
2. Select one of the following:
 - Save/Load Settings > Save Settings to SpeedDrive
 - Save/Load Settings > Save Settings to SD Card
3. Use the on-screen keyboard (Or attached USB keyboard) to enter a name for the settings file.
4. Select OK (Or press Enter on an attached USB keyboard) to save the settings file.

To recall settings from the SD card or SpeedDrive:

1. Press the MENU button.
2. Select one of the following:
 - Save/Load Settings > Load Settings from SpeedDrive
 - Save/Load Settings > Load Settings from SD Card.
3. Select a settings file.

Restoring Factory Default Settings

Should it ever become necessary to restore all settings on the monitor to its original factory defaults, the Main menu provides an option to do that.

⚠ *Restoring defaults will remove all custom modifications to the various monitoring tools.*

To restore factory default settings:

1. Press the MENU button.
2. Select Save/Load Settings > Revert to Factory Settings.





Helpful Shortcuts

This chapter provides a quick reference list of shortcuts, how to view the HELP screen, and more details regarding the procedure for capturing still images of the monitor's on-screen display.

Topics in this section include:

- ▶ Viewing the HELP Screen
- ▶ Shortcuts
- ▶ Capturing the Screen Display

Viewing the HELP Screen

The HELP screen provides an on-screen quick reference list of shortcut key combinations and their associated functions.

To access the HELP screen:

- ▶ Press the MENU button and select Help.

Shortcuts

The following table provides further details regarding key functionality and corresponding shortcuts.

SHORTCUT	FUNCTION
Press MENU or press ALT	Exits out of menus and returns display to home screen
Press ALT	Secondary functionality of soft key buttons
Hold MENU	Displays Monitor menu for access to: <ul style="list-style-type: none"> • Headphone gain • Headphone source • OSD settings: transparency, brightness, contrast, and chroma • LCD backlight level • PIX-LR LED brightness level
Hold False soft key button	Access False Color settings
Hold Zebra soft key button	Access Zebra settings
Hold WFM soft key button	Access Waveform Monitor settings
Hold Vector soft key button	Access Vectorscope settings
Hold Hist soft key button	Access Histogram settings
Hold LUT soft key button	Compare LUTs and view current LUT selection
Hold Zoom soft key button	Access Zoom settings
Hold Peak soft key button	Access Peaking filter settings
Hold Marker soft key button	Access to configure guide markers
ALT + Control Knob	Reset current setting to original default
ALT + False (or Audio)	Capture image of OSD in PNG format
ALT + Zebra (or Files)	Capture image of OSD in JPG format

① *For time-saving keystroke combinations, when using an attached USB keyboard, see [USB Keyboard](#).*

Capturing the Screen Display

It may become necessary to capture a snapshot of what appears on the monitor's screen. Such snapshots can be beneficial for storyboarding, comparing lighting setups, continuity troubleshooting, and so forth. The monitor captures the on-screen display as either JPG or PNG images, which are saved to the SpeedDrive or SD memory card for later viewing on a PC or Mac.

To capture a snapshot of the OSD:

- ▶ Press ALT + 2nd soft key button to capture image in PNG format.
- ▶ Press ALT + 3rd soft key button to capture image in JPG format.

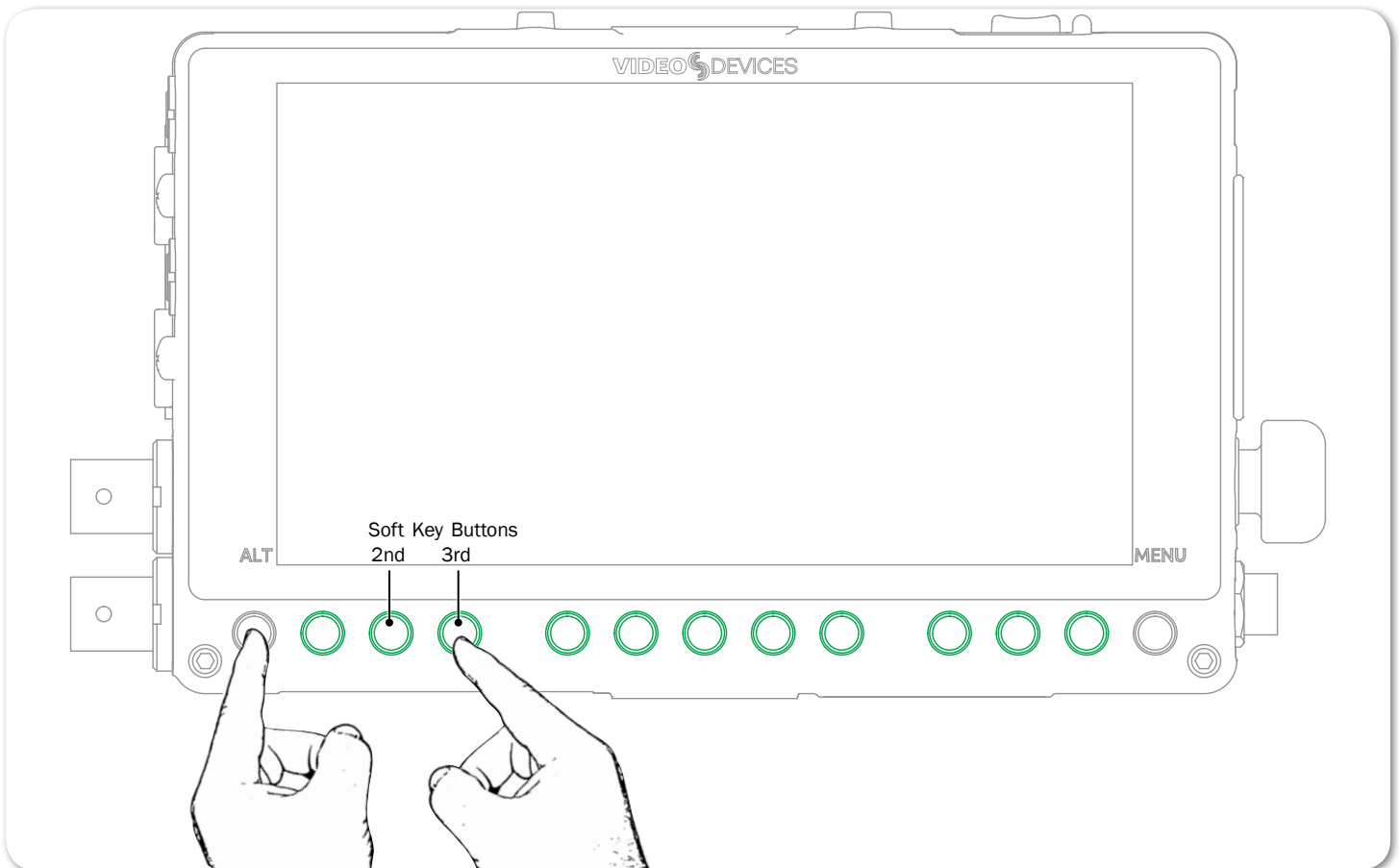

- ① *The soft key labels for the 2nd and 3rd soft key buttons vary depending on current button functionality. For instance, the 2nd button may be labeled either False or Audio, and the 3rd button may be labeled either Zebra or Files.*

When capturing a snapshot of the screen, the image will show everything displayed on the screen at the time. This includes OSD elements, if activated, such as the information bar and soft key labels, as well as guide markers, scopes or monitoring filters, and any menus or dialog boxes. To capture a snapshot of only the video image, turn off the display of all other on-screen elements, scopes, and filters beforehand.

Specifications

This chapter provides specifications for both the PIX-E5 and PIX-E5H monitors. Although the monitors share many features and similarities, there are some differences.

The specifications are provided in separate sections for clarity.

Topics in this section include:

▶ PIX-E5 Specifications

- ▶ Video
- ▶ Audio
- ▶ Storage
- ▶ Timecode
- ▶ Power
- ▶ Physical
- ▶ Environmental

▶ PIX-E5H Specifications

- ▶ Video
- ▶ Audio
- ▶ Storage
- ▶ Timecode
- ▶ Power
- ▶ Physical
- ▶ Environmental

PIX-E5 Specifications

Video

HDMI	Input <ul style="list-style-type: none">• 4:4:4 or 4:2:2, 8/10/12 bit, RGB or YCbCr• Version 1.4a• HDCP enabled	Output <ul style="list-style-type: none">• 4:2:2, 8 bit, YCbCr• Version 1.3
SDI	Input <ul style="list-style-type: none">• 6G-SDI, 3G-SDI (level A and B), HD-SDI• 4:4:4 or 4:2:2, 8/10/12 bit, RGB or YCbCr• SMPTE 292, and 424	Output <ul style="list-style-type: none">• HD-SDI• 4:2:2, 10 bit, YCbCr• SMPTE 292• Progressive, 30fps max

Supported Input Resolutions and Rates	<ul style="list-style-type: none"> • 4096p30 • 4096p29.97 • 4096p25 • 4096p24 • 4096p23.98 • 3840p30 • 3840p29.97 • 3840p25 • 3840p24 • 3840p23.98 • 1080p120** • 1080p119.88** • 1080p100** • 1080p60 • 1080p59.94 • 1080p50 • 1080p30 • 1080p29.97 • 1080p25 • 1080p24 • 1080p23.976 • 1080i60 • 1080i59.94 • 1080i50 • 1080PsF30* • 1080PsF29.97* • 1080PsF25* • 1080PsF24* • 1080PsF23.976* • 720p120** • 720p119.88** • 720p100** • 720p60 • 720p59.94 • 720p50 • 720p30* • 720p29.97* • 720p25* • 720p24* • 720p23.976*
	* SDI only, ** HDMI only
Codecs (Max resolution & frame rate)	<ul style="list-style-type: none"> • Apple ProRes 4444XQ, 12 bit* (1080p30) • Apple ProRes 4444, 12 bit (1080p30) • Apple ProRes 422HQ, 10 bit (4kp30 / 1080p120 / 720p60) • Apple ProRes 422, 10 bit (4kp30 / 1080p120 / 720p60) • Apple ProRes 422LT, 10 bit (4kp30 / 1080p120 / 720p60) • Apple ProRes 422Proxy, 10 bit (4kp30 / 1080p120 / 720p60) • H.264 (Variable bit rate - typical 5-10 Mbs)
	* SDI Log-encoded inputs only
4K to HD Conversion	<ul style="list-style-type: none"> • 4K input to HD output • Automatic 4K to 1080p scaling for H.264
Input to file conversion	<ul style="list-style-type: none"> • 1080i to PsF • PsF to P
Video I/O conversion	<ul style="list-style-type: none"> • SDI to HDMI • HDMI to SDI
LCD Display	<ul style="list-style-type: none"> • 5-inch In-Plane Switching (IPS) Liquid Crystal Display (LCD) • Gorilla® Glass 2 • Capacitive touch screen • 1920 x 1080 pixel resolution with true 16x9 ratio • 441 ppi • 179° angle of view • 500 nits brightness • 1000:1 contrast ratio

Audio

HDMI	4 channels embedded HDMI input, 8 channels embedded HDMI output
SDI	8 channels embedded SDI input, 8 channels embedded SDI output
H.264	2 channels AAC-encoded audio (channels 1 & 2)
Headphone	1/8 in (3.5 mm) TRS with gain control
Line In	1/8 in (3.5 mm) TRS, Unbalanced 2-channel
Sample rate / bit depth	<ul style="list-style-type: none"> • 24-bit • Sample rate synced to active video input (SDI or HDMI). Typically 48 kHz.

Storage

Formats	<ul style="list-style-type: none"> • exFAT drive format (SpeedDrive and SD card) • Quicktime (.mov) video file format (SpeedDrive) • (.mp4) video file format (SpeedDrive and SD card) • XML setup file format (SpeedDrive and SD card)
SpeedDrive™	<ul style="list-style-type: none"> • Internal mSATA Drive • USB 3.0 interface • Dimensions (HxWxD): 3.35 in x 1.5 in x 0.5 in • Weight: 1.2 oz (without drive)
SD card	<ul style="list-style-type: none"> • Types: SD, SDHC, SDXC

① See list of approved media at: www.videodevices.com/approved.

Timecode

Modes Supported	<ul style="list-style-type: none"> • Ext TC (SDI/HDMI) (RP188) • Time of Day • Rec Run • Ext TC (Line In 1) • Ext TC (Line In 2) <p>① Start timecode is stamped in the QuickTime file. LTC may be striped to Line In 1 or Line In 2 audio tracks.</p>
Frame Rates	23.976, 24, 25, 29.97DF, 29.97ND, 30DF, 30ND
Inputs	<ul style="list-style-type: none"> • SDI Input BNC • HDMI Input • Line In 3.5 mm
Outputs	<ul style="list-style-type: none"> • SDI Output BNC

Power

External	External 10-34VDC, threaded coaxial connector (5.5mm outer diameter, 2.1mm inner diameter), pin positive, sleeve negative
Batteries	2x Removable 7.2v (nominal) Sony type L Series Lithium-Ion
Power Draw	12-15W quiescent, depending on settings

Physical

Dimensions (HxWxD)	3.4 in x 5.4 in x 1.6 in (8.6 cm x 13.8 cm x 4.1 cm)
Weight	16 oz (1 lb)

Environmental

Operating Temperature	-10° C to +40° C
-----------------------	------------------

PIX-E5H Specifications

Video

HDMI	Input	Output
	<ul style="list-style-type: none"> • 4:4:4 or 4:2:2, 8/10/12 bit, RGB or YCbCr • Version 1.4a • HDCP enabled 	<ul style="list-style-type: none"> • 4:2:2, 8 bit, YCbCr • Version 1.3 • 1080p30 or 720p60 max
Supported Input Resolutions and Rates	<ul style="list-style-type: none"> • 4096p30 • 4096p29.97 • 4096p25 • 4096p24 • 4096p23.98 • 3840p30 • 3840p29.97 • 3840p25 • 3840p24 • 3840p23.98 	<ul style="list-style-type: none"> • 1080p120 • 1080p119.88 • 1080p100 • 1080p60 • 1080p59.94 • 1080p30 • 1080p29.97 • 1080p25 • 1080p24 • 1080p23.976
Codecs	<ul style="list-style-type: none"> • Apple ProRes 422 HQ, 10 bit • Apple ProRes 422, 10 bit • Apple ProRes 422 LT, 10 bit • Apple ProRes 422 Proxy, 10 bit • H.264 (Variable bit rate - typical 5-10 Mbs) 	<ul style="list-style-type: none"> • 1080i60 • 1080i59.94 • 1080i50 • 720p120 • 720p119.88 • 720p100 • 720p60 • 720p59.94 • 720p50
4K to HD Conversion	<ul style="list-style-type: none"> • 4K input to HD output • Automatic 4K to 1080p scaling for H.264 	
Input to file conversion	<ul style="list-style-type: none"> • 1080i to PsF • PsF to P 	
LCD Display	<ul style="list-style-type: none"> • 5-inch IPS LCD • Gorilla® Glass 2 • Capacitive touch screen • 1920 x 1080 pixel resolution with true 16x9 ratio • 441 ppi • 179° angle of view • 500 nits brightness • 1000:1 contrast ratio 	

Audio

HDMI	4 channels embedded HDMI input, 8 channels embedded HDMI output
H.264	2 channels AAC-encoded audio (channels 1 & 2)
Headphone	1/8 in (3.5 mm) TRS with gain control
Line In	1/8 in (3.5 mm) TRS, Unbalanced 2-channel
Sample rate / bit depth	<ul style="list-style-type: none"> • 24-bit • Sample rate synced to active video input (HDMI). Typically 48 kHz

Storage

Formats	<ul style="list-style-type: none"> • exFAT drive format (SpeedDrive and SD card) • Quicktime (.mov) video file format (SpeedDrive) • (.mp4) video file format (SpeedDrive and SD card) • XML setup file format (SpeedDrive and SD card)
SpeedDrive™	<ul style="list-style-type: none"> • Internal mSATA Drive • USB 3.0 interface • Dimensions (HxWxD): 3.35 in x 1.5 in x 0.5 in • Weight: 1.2 oz (without drive)
SD card	<ul style="list-style-type: none"> • Types: SD, SDHC, SDXC

① See list of approved media at: www.videodevices.com/approved.

Timecode

Modes Supported	<ul style="list-style-type: none"> • Ext TC (HDMI) • Time of Day • Rec Run • Ext TC (Line In 1) • Ext TC (Line In 2) <p>① Start timecode is stamped in the QuickTime file. LTC may be striped to Line In 1 or Line In 2 audio tracks.</p>
Frame Rates	23.976, 24, 25, 29.97DF, 29.97ND, 30DF, 30ND
Inputs	<ul style="list-style-type: none"> • HDMI Input • Line In 3.5 mm

Power

External	External 10-34VDC, threaded coaxial connector (5.5mm outer diameter, 2.1mm inner diameter), pin positive, sleeve negative
Batteries	2x Removable 7.2v (nominal) Sony type L Series Lithium-Ion
Power Draw	12-15W quiescent, depending on settings

Physical

Dimensions (HxWxD)	3.4 in x 5.4 in x 1.6 in (8.6 cm x 13.8 cm x 4.1 cm)
Weight	15.3 oz (0.96 lb)

Environmental

Operating Temperature	-10° C to +40° C
-----------------------	------------------

PIX-LR Audio Interface

The PIX-LR is an accessory that provides the PIX-E Series with two XLR inputs, two XLR outputs, accurate LED metering, and dedicated transport and gain controls.

The mic preamps within the PIX-LR are some of the highest-quality preamps available, and the same preamps for which Sound Devices, LLC is world-famous. These active-balanced preamps are sonically pure with extremely low self-noise, high headroom, and low distortion. They also include excellent input limiters, which keep the input from overloading, even with unexpected loud noises or shouting right into the microphones. And they include full-spec 48 V phantom for high-quality condenser mics and low-cut filters to cut wind noise and room rumble.

Topics in this section include:

- ▶ Front Panel
- ▶ Top Panel
- ▶ Back Panel
- ▶ Assigning Audio Input Sources to XLR
- ▶ Modifying Audio Settings
- ▶ Audio Screen Differences with PIX-LR
- ▶ Adjusting Gain with the PIX-LR
- ▶ Choosing a Headphone Source
- ▶ Adjusting PIX-LR LED Brightness
- ▶ Specifications
- ▶ Declaration of Conformity

Front Panel

The front panel has the following features:

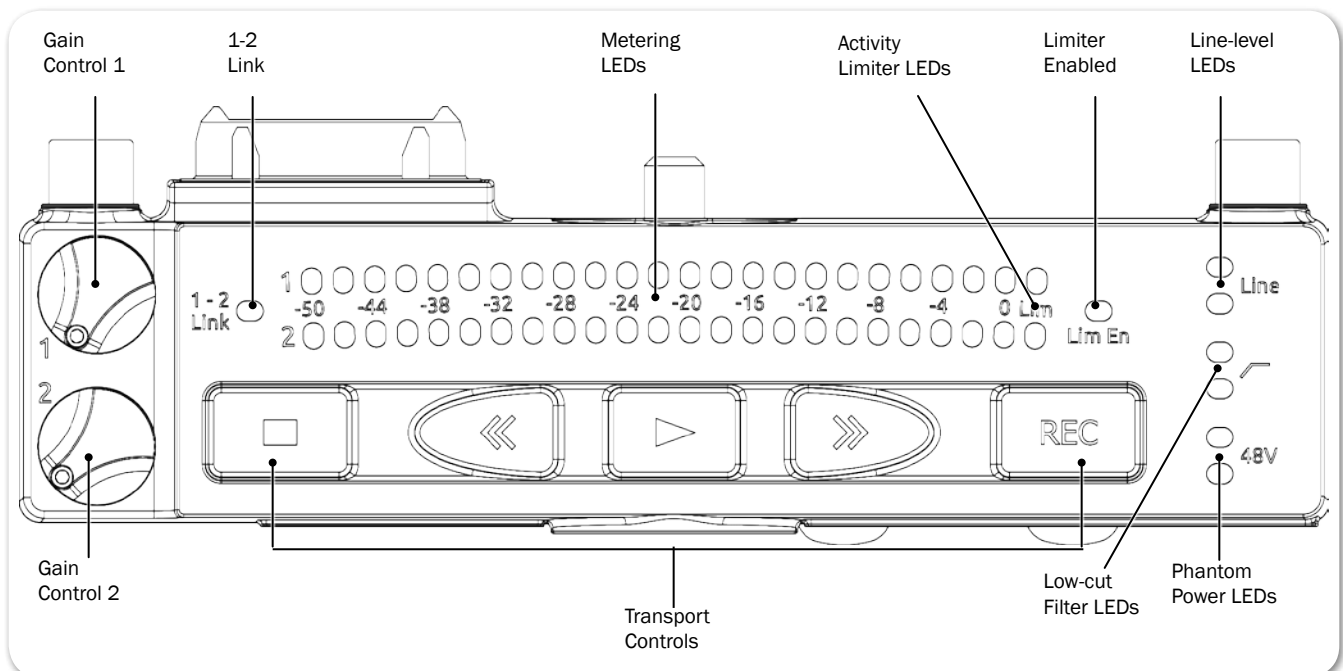

FEATURE	DESCRIPTION
Transport Controls	Five large, backlit buttons for transport controls: Stop, Rewind, Play, Fast Forward, and Record.
Gain Controls (1-2)	Two dedicated gain controls for XLR inputs 1 and 2. Gain range for both XLR inputs is $-\infty$ to +72 dB.
1-2 Link LED	Indicates when XLR inputs 1 and 2 are a linked stereo pair.
Metering LEDs	Track metering LEDs
Active Limiter LEDs	Illuminates when limiting occurs.
Limiter Enabled LED	Illuminates when limiter is enabled.
Line LEDs	Illuminates when XLR inputs are set to line level; Off when set to Mic.
High-Pass Filter LEDs	Illuminates when the low-cut filter is enabled for the XLR input(s)
Phantom LEDs	Illuminates when phantom power (48 V) is active for the input(s).

Top Panel

The top panel provides the multi-pin connector and mounting screw used to connect the accessory to the bottom panel of PIX-E monitors.

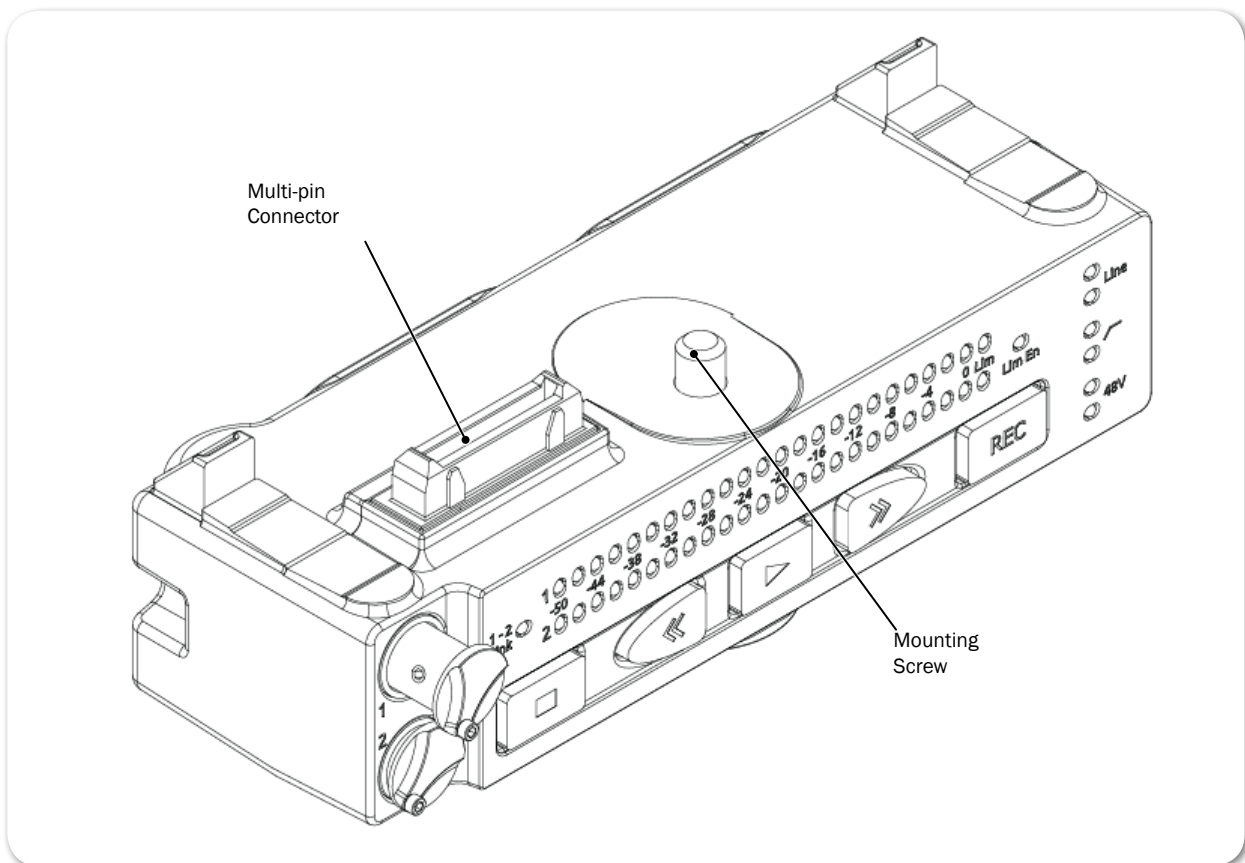

- ① *The PIX-LR attaches to the bottom panel of PIX-E monitors. Sound Devices, LLC recommends, as a best practice, the monitor's power be turned off and unplugged before affixing the accessory. Further instructions for attaching the PIX-LR to your monitor is provided in the [PIX-LR Quick Start Guide](#), which is shipped with the accessory. It is also available as a free PDF download from the [Video Devices website](#).*

Back Panel

The back panel has the following connectors:

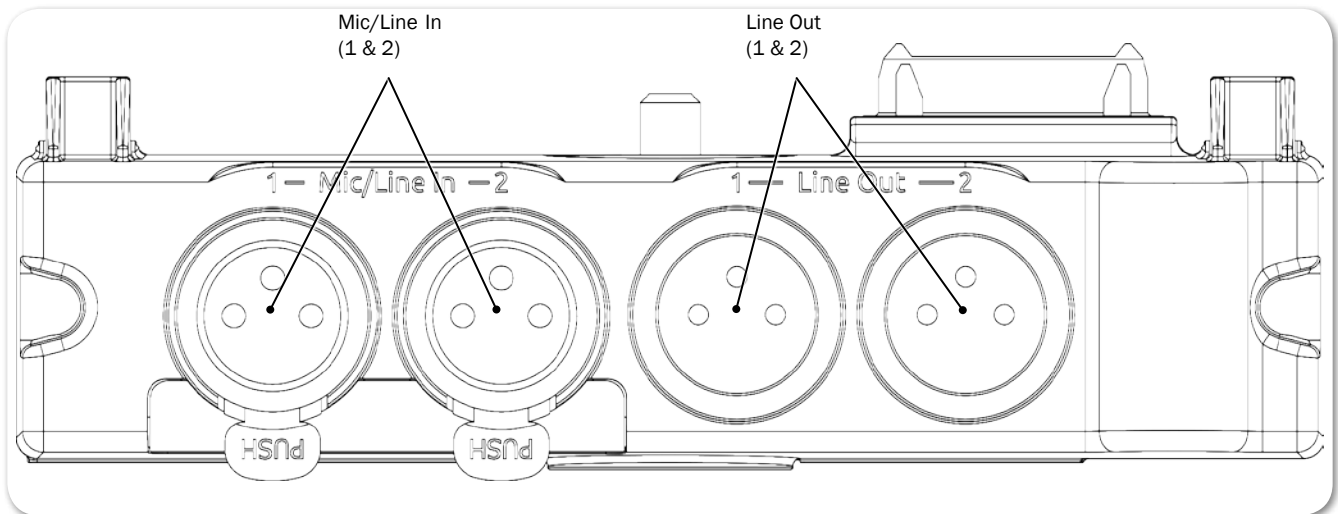

FEATURE	DESCRIPTION
Mic/Line	Two XLR connectors for active-balanced, analog microphone- or line-level inputs (1 and 2). [Pin-1 ground; pin-2 (+); pin-3 (-).]
Line Out	Two standard, 3-pin XLR connectors for balanced, line-level analog outputs. [Pin-1 ground; pin-2 hot (+); pin-3 cold (-).] In addition to their use as normal balanced outputs, the XLR outputs may also be connected as unbalanced. When doing so, connect pin 1 to ground, pin 2 to signal, and leave pin 3 unconnected.

Assigning Audio Input Sources to XLR

When the PIX-LR is attached, both XLR 1 and XLR 2 options become viable audio sources for the PIX-E monitor.

To set the audio input source to the PIX-LR inputs:

1. Press the Audio soft key button to access the Audio screen.
1. Use the Control knob to select the track to adjust.
2. Turn and press the Control knob to select the track's Source field.
3. Set the input source to XLR 1 or XLR 2.

① *The Audio screen is slightly different when the PIX-LR is attached. For more information, see [Audio Screen Differences with PIX-LR](#).*

Modifying Audio Settings

When the PIX-LR is attached to a PIX-E monitor, additional settings become available via the monitor's Audio submenu.

To modify the Audio submenu's PIX-LR settings:

1. Press the MENU button to view the Main menu.
2. Select Audio and adjust settings as needed.

The settings associated with the PIX-LR are:

SETTING	DESCRIPTION
XLR 1 Input	Sets input type for XLR 1. Default is Line. Options include: Line, Mic, Line 48V Phantom, Mic 48V Phantom
XLR 2 Input	Sets input type for XLR 2. Default is Line. Options include: Line, Mic, Line 48V Phantom, Mic 48V Phantom The default setting for both inputs is Mic.
	① <i>48 V phantom is needed to power many professional condenser microphones. If using professional dynamic microphones, 48 V phantom is not needed and can be turned off.</i>
XLR 1 Input Low Cut	Sets low cut frequency for analog XLR input 1. Options include: Off, 40 Hz, 80 Hz, 120 Hz, 160 Hz, 200 Hz, or 240 Hz
XLR 2 Input Low Cut	Sets low cut frequency for analog XLR input 2. Options include: Off, 40 Hz, 80 Hz, 120 Hz, 160 Hz, 200 Hz, or 240 Hz Input Low Cut settings for both XLR inputs are off by default.
	① <i>The low cut filter removes low-frequency bass sound, such as wind noise or room rumble, to make microphones sound better. If the input sounds too "rumbly," turn on the low-cut filter to the lowest number needed to make the input sound better.</i>
XLR Input Linking	Selects whether the input levels are controlled independently (unlinked) or as a stereo pair (linked). Options include: Off, 1-2 Linked without Pan, and 1-2 Linked with Pan. Linking is off by default.
	For more information, see Adjusting Gain with the PIX-LR . ① <i>Limiters are linked and will act together.</i>
XLR Input Limiter	Turns XLR input limiter on or off. Limiter is on by default. A limiter quickly and automatically turns an input down momentarily, just enough to keep the input from overloading and sounding very distorted. This automatic gain-reduction happens only during the overload, and otherwise does not affect the incoming signal. ① <i>Sound Devices, LLC recommends always keeping the limiter turned on.</i>

SETTING	DESCRIPTION
XLR Output Source	<p>Sets the XLR output source. Options include:</p> <ul style="list-style-type: none"> • XLR Input 1,2 • Tracks 1,2 • Tracks 3,4 • Tracks 5,6 • Tracks 7,8 • All tracks summed - mono • All tracks summed - stereo <p>When set to All tracks summed - mono, all tracks (12345678) go to both 1 and 2.</p> <p>When set to All tracks summed - stereo, odd tracks (1357) go to 1 and even tracks (2468) go to 2. By default, the source is set to All tracks summed - stereo.</p> <p>The source chosen for this setting is displayed on the monitor's Audio screen. For instance, when set to the default of All tracks summed - stereo, the Audio screen displays XLR Out: Tracks 1357, 2468 in the upper right corner.</p> <p><i>① When XLR Input 1,2 is chosen as the output source, then XLR 1,2 is used while recording. During playback, however, the source used is Tracks 1,2. Once playback is stopped, the output source reverts back XLR Input 1, 2.</i></p>
XLR Output Attenuation	<p>Adjusts output attenuation in 1db increments: 0 to -20dB, Off XLR output attenuation is set to 0 dB by default.</p>
PIX-LR LED Meters	<p>Sets the PIX-LR LEDs to meter specified pairs. Options include:</p> <ul style="list-style-type: none"> • Tracks 1 & 2 • Tracks 3 & 4 • Tracks 5 & 6 • Tracks 7 & 8 • XLR 1 & 2 <p>By default, LED metering is set to XLR 1 & 2.</p> <p><i>① When XLR 1 & 2 is chosen for LED metering, then metering of XLR inputs 1 and 2 is used while recording. During playback, however, the LEDs show the metering of Tracks 1 and 2. Once playback is stopped, LED metering reverts back to XLR 1 & 2.</i></p>

Audio Screen Differences with PIX-LR

The PIX-E monitor's Audio screen differs slightly whenever a PIX-LR is attached. For instance, when the audio input source for any track is set to XLR 1 or XLR 2, the corresponding fields in the Gain column can no longer be selected by using the monitor's Control knob. Additionally, after the XLR Output Source is set, the chosen source is displayed in the upper right corner of the Audio screen.

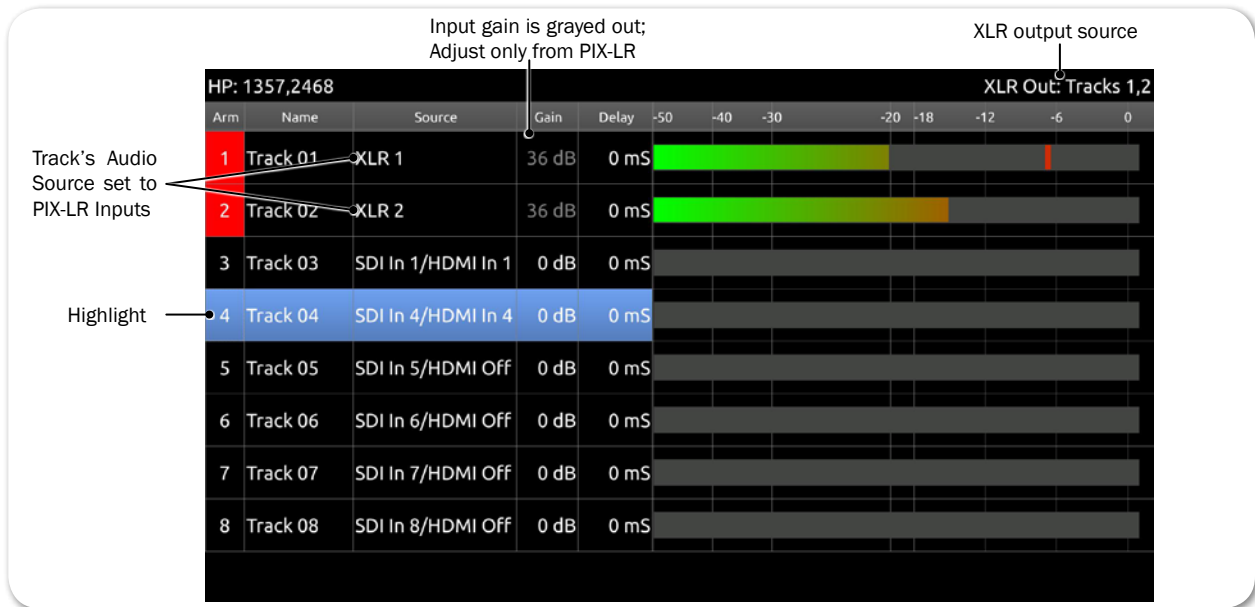

Levels shown in the Gain column of the Audio screen are normally adjusted with the Control knob, but when a track's audio source is set to XLR inputs, level adjustment is transferred to the PIX-LR's rotary gain controls. Therefore, the fields in the Gain column become disabled (grayed out) and are no longer adjustable from the Audio screen, using the Control knob. Although disabled, the fields in the Gain column still display present levels and any adjustments as they are made from the PIX-LR. This is particularly useful when XLR Input Linking with or without Pan is enabled, because the Audio screen shows the changes in gain levels while adjusting overall levels or the balance between inputs.

Adjusting Gain with the PIX-LR

With the PIX-LR attached and a track's audio source set to an XLR input, manual adjustment of gain levels is transferred to the PIX-LR's rotary gain controls.

For instance, if the source for Track 01 is set to XLR 1 and Track 02 is set to XLR 2, then turning gain control 1 adjusts levels for Track 01 on XLR 1, while turning gain control 2 adjusts levels for Track 02 on XLR 2.

This functionality changes, however, when Input Linking is enabled, which may be set with or without pan. When enabled, the linkage is indicated by the amber illumination of the 1-2 Link LED on the front panel of the PIX-LR, and the gain controls operate differently depending on whether pan is included in the configuration.

Audio Screen on PIX-E

Arm	Name	Source	Gain	Delay	-50	-40	-30	-20	-18	-12	-6	0
1	Track 01	XLR 1	36 dB	0 mS	[Level Meter]							
2	Track 02	XLR 2	36 dB	0 mS	[Level Meter]							
3	Track 03	SDI In 1/HDMI In 1	0 dB	0 mS	[Level Meter]							
4	Track 04	SDI In 4/HDMI In 4	0 dB	0 mS	[Level Meter]							
5	Track 05	SDI In 5/HDMI Off	0 dB	0 mS	[Level Meter]							
6	Track 06	SDI In 6/HDMI Off	0 dB	0 mS	[Level Meter]							
7	Track 07	SDI In 7/HDMI Off	0 dB	0 mS	[Level Meter]							
8	Track 08	SDI In 8/HDMI Off	0 dB	0 mS	[Level Meter]							

PIX-LR: Gain Control 1

PIX-LR: Gain Control 2 (Disabled)

1-2 Link LED (Amber)

[SEE DEMO VIDEO](#)

As shown in the previous illustration, when linking is set to 1-2 Linked without Pan, gain control 1 adjusts the overall gain level of both XLR inputs, while gain control 2 is disabled.

When linking is set to 1-2 Linked with Pan, gain control 1 still adjusts the overall level of both XLR inputs, but gain control 2 adjusts the balance between the inputs, as shown in the next illustration.

Audio Screen (partial)

Arm	Name	Source	Gain	Delay	-50	-40
1	Track 01	XLR 1	16 dB	0 mS	[Level Meter]	
2	Track 02	XLR 2	31 dB	0 mS	[Level Meter]	
3	Track 03	SDI In 1/HDMI In 1	0 dB	0 mS	[Level Meter]	

Counter-clockwise

Clockwise

1-2 Link LED

- Turning gain control 2 counter-clockwise fully attenuates XLR input 2.
- Turning gain control 2 clockwise fully attenuates XLR input 1.

Equal balance of the two inputs is achieved by setting the controls to center position.

Choosing a Headphone Source

Every PIX-E monitor features a 3.5 mm headphone output. The audio source for this output is user-definable. When the PIX-LR is attached, existing options are slightly renamed and four new options appear.

To choose a headphone source:

1. Press and hold the MENU button for 1 second to access the Monitor menu.
2. Use the Control knob to select the HP Source tab.



3. Select a headphone source.

SOURCE WITH PIX-LR	DESCRIPTION	SOURCE NAME w/o PIX-LR
Track 1,2	Select this stereo option for routing channel 1 to the left and 2 to the right.	1,2
Track 3,4	Select this stereo option for routing channel 3 to the left and 4 to the right.	3,4
Track 5,6	Select this stereo option for routing channel 5 to the left and 6 to the right.	5,6
Track 7,8	Select this stereo option for routing channel 7 to the left and 8 to the right.	7,8
Track Odd, Even	Select this stereo option for routing odd channels to the left and even channels to the right.	1357,2468
Track All	Select this mono option if you want all audio inputs routed to both sides of headphones.	12345678
XLR 1	Select this option for routing XLR 1 to both sides of headphones.	
XLR 2	Select this option for routing XLR 2 to both sides of headphones.	
XLR 1,2	Select this stereo option for routing XLR 1 to the left and XLR 2 to the right.	
XLR 12	Select this mono option if you want both XLR inputs routed to both sides of headphones.	

The XLR source options provide a low-latency path to the headphone monitor and to the XLR outputs. When monitoring track sources on headphones or the XLR outputs, the track audio is delayed to match the displayed video.

- ① *When HP Source is set to any of the XLR options, playback temporarily switches the source for headphone monitoring to Track 1,2. After playback is stopped, the source reverts back to the actual XLR option selected.*

Adjusting PIX-LR LED Brightness

When the PIX-LR is attached to a PIX-E monitor, an additional setting becomes available in the Monitor menu. Called PIX-LR LEDs, this setting may be used to adjust the brightness of the accessory's LEDs as well as its back-lit transport controls.

To adjust PIX-LR LED brightness:

1. Press and hold the MENU button for 1 second. The Monitor menu appears superimposed over the lower portion of the screen.
2. Select the PIX-LR LEDs tab and then adjust the level of brightness from 0% (off) to 100%. By default, the brightness level is set to 70%.

Specifications

The following specifications apply to the PIX-LR.

NAME	DESCRIPTION
Power	Powered by the monitor.
Frequency response	10 Hz - 20 kHz +0,-0.5 dB re 1 kHz
THD+N	0.05% max (20-20kHz filter), 0dBu in, gain +12 dB
Max Gain (mic position)	+72 dB (dBu in to -20dBFS)
Gain (line position)	+45 dB (dBu in to -20dBFS)
Max input level (mic position)	+8 dBu (gain at +12 dB)
Max input level (line position)	+26 dBu (gain at +12 dB)
Equivalent input noise (mic position)	-128 dBu (A-weighted)
Max line output level	+18 dBu (2k load)
Input limiters	40 dB range, 20:1 ratio, 1 mS attack, 200 mS release
Low cut filters	Selectable frequency, 12 dB/oct
48 V phantom	Full 10 mA each
XLR wiring (in and out)	Pin 2 = hot, pin 3 = cold, pin 1 = ground To drive unbalanced source from output, only use pins 2 and 1; leave pin 3 disconnected.
XLR protection (in and out)	Protected against 48V phantom, shorts, and fully RF-filtered
Size (H x W x D)	· 1.3 in x 5.4 in x 2.1 in · 3.3 cm x 13.7 cm x 5.3 cm
Weight	· 8.0 oz · 0.23 kg

Declaration of Conformity

SOUND  DEVICES	Declaration of Conformity	
---	---------------------------	---

Manufacturer's Name: Sound Devices, LLC
Manufacturer's Address: E7556 State Road 23 and 33
Reedsburg, WI 53959 USA

Declares under sole responsibility that the product as delivered

Product Name: PIX-LR Audio Interface
Model Number: PIX-LR
Description: Audio Interface Accessory for the PIX-E Series
Product Options: This declaration covers all options of the above product

complies with the essential requirements of the following applicable European Directives, and carries the CE marking accordingly:

EMC Directive (2014/30/EU)
EN 55022:2010
EN 55103-2:2009
RoHS Directive (2011/65/EU)
WEEE Directive (2012/19/EU)



This Declaration of Conformity applies to the above-listed product(s) placed on the EU market after:

December 23, 2015

Date



Matt Anderson
President
Sound Devices, LLC



Sound Devices, LLC
E7556 Road 23 and 33
Reedsburg, Wisconsin 53959
USA

Phone: +1 (608) 524-0625
Fax: +1 (608) 524-0655

Customer Support

Toll Free: (800) 505-0625

Email: support@sounddevices.com
<http://www.sounddevices.com/support>
<http://forum.sounddevices.com>

Product Information

For more information about products and accessories, visit us on the web at www.sounddevices.com.

Report Documentation Error

Email: techpubs@sounddevices.com