

Canon

RF

24-105mm F4 L IS USM

Instructions

ENG

Thank you for purchasing a Canon product.

Canon's RF24-105mm F4 L IS USM is a standard zoom lens for use with EOS R series cameras.

- "IS" stands for Image Stabilizer.
- "USM" stands for Ultrasonic Motor.

Camera Firmware

Please use the latest version of firmware with the camera in use. For details on whether the firmware is the latest version or not, and for details on updating the firmware, please check the Canon website.

Conventions used in these instructions



Warning to prevent lens or camera malfunction or damage.



Supplementary notes on using the lens and taking pictures.

Safety Precautions

Precautions to ensure that the camera is used safely. Read these precautions thoroughly. Make sure all details are observed in order to prevent risks and injury to the user and other people.



Warning

Details pertaining to risks that may result in death or serious injury.

- **Do not look directly at the sun or other strong light sources through a lens.** This may result in loss of sight.
- **Do not leave a lens in the sun without the lens cap attached.** The lens may concentrate entering sunlight and cause a malfunction or fire.



Caution

Details pertaining to risks that may result in injury.

- **Do not leave the product in places exposed to extremely high or low temperatures.** The product may cause burns or injury when touched.
- **Do not insert your hand or fingers into the product.** This may result in injury.

Caution

Details pertaining to risks that may result in damage to property.

- **Do not leave the product in excessive heat such as in a car in direct sunlight.** High temperatures can cause the product to malfunction.

General Precautions

Handling Precautions

- If the lens is taken from a cold environment into a warm one, condensation may develop on the lens surface and internal parts. To prevent condensation in this case, first put the lens into an airtight plastic bag before taking it from a cold to warm environment. Then take out the lens after it has warmed gradually. Do the same when taking the lens from a warm environment into a cold one.
- Please also read any lens related handling precautions listed in your camera's instruction manual.

This device complies with Part 15 of the FCC Rules.

Operation is subject to the following two conditions: (1) This device may not cause harmful interference, and (2) this device must accept any interference received, including interference that may cause undesired operation.

Do not make any changes or modifications to the equipment unless otherwise specified in the instructions. If such changes or modifications should be made, you could be required to stop operation of the equipment.

This equipment has been tested and found to comply with the limits for a class B digital device, pursuant to part 15 of the FCC Rules. These limits are designed to provide reasonable protection against harmful interference in a residential installation. This equipment generates, uses and can radiate radio frequency energy and, if not installed and used in accordance with the instructions, may cause harmful interference to radio communications.

However, there is no guarantee that interference will not occur in a particular installation. If this equipment does cause harmful interference to radio or television reception, which can be determined by turning the equipment off and on, the user is encouraged to try to correct the interference by one or more of the following measures:

- Reorient or relocate the receiving antenna.
- Increase the separation between the equipment and receiver.
- Connect the equipment into an outlet on a circuit different from that to which the receiver is connected.
- Consult the dealer or an experienced radio/TV technician for help.

Nomenclature

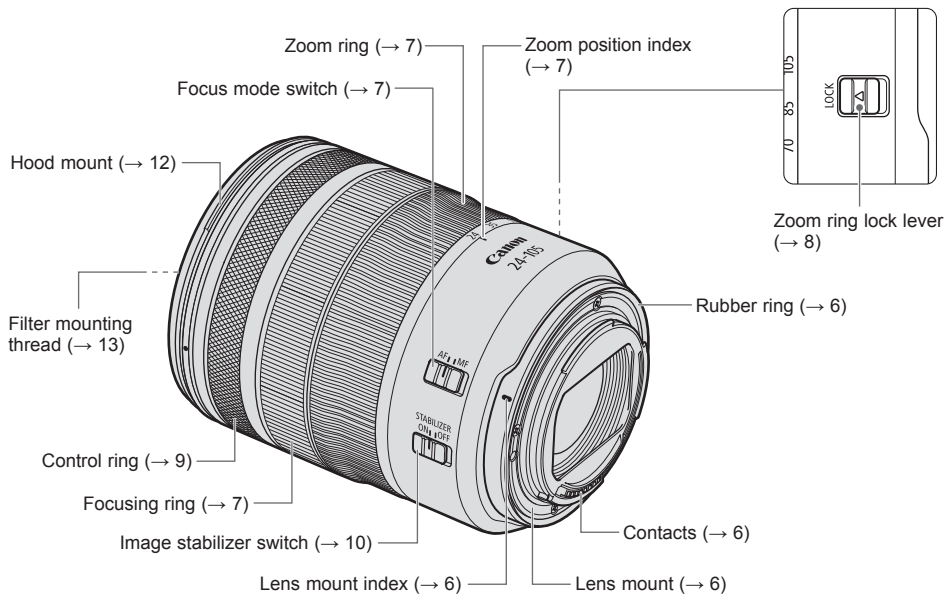

- For detailed information, reference page numbers are provided in parentheses (→ **).

1. Attaching and Detaching the Lens

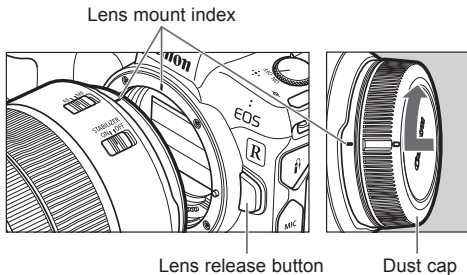

Attaching the Lens

Align the lens mount indexes of the lens and camera, and turn the lens clockwise until you hear a click.

Detaching the Lens

Turn the lens counterclockwise while pressing the camera's lens release button. Detach the lens once it has stopped turning.

Please refer to the camera's instructions for details.



- Set the camera's power switch to OFF when attaching or detaching the lens.
- Attach the lens cap before detaching the lens from the camera.
- After detaching the lens, place the lens with the rear end up and attach the dust cap to prevent the lens surface and contacts from getting scratched. Make sure the lens and dust cap mount indexes are aligned when attaching the dust cap.
- Contacts that are scratched, soiled, or have fingerprints on them may result in faulty connections or corrosion, which may lead to malfunctions. If the contacts get soiled, clean them with a soft cloth.
- The lens mount has a rubber ring to improve dust-resistance and water-resistance performance. This rubber ring may cause friction marks to appear around the camera's lens mount, although this will have no effect on usage.



- Rubber rings can be replaced at Canon Service Center. (chargeable)

2. Setting the Focus Mode

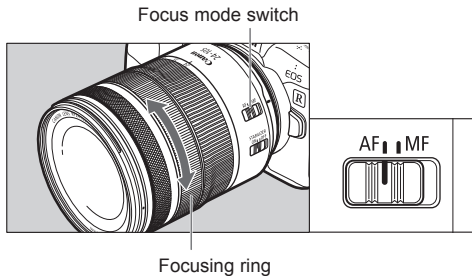

To shoot in autofocus (AF) mode, set the focus mode switch to AF.

To use only manual focusing (MF), set the focus mode switch to MF, and focus by turning the focusing ring.

- Quickly turning the focusing ring may result in delayed focus.

- The lens' focusing ring is electronic.
- When AF operation is set to [ONE SHOT], manual focus is possible after autofocus has been completed by continuing to press the shutter button halfway. (Full-time manual focus) However, the camera settings need to be changed.

3. Zooming

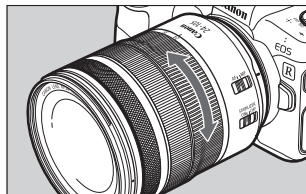

To zoom, turn the lens' zoom ring.

- Be sure to finish zooming before focusing. Zooming after focusing can affect the focus.
- Blurring may temporarily occur if the zoom ring is quickly turned.

4. Fixing the Zoom Ring

The zoom ring can be fixed to keep the lens at the shortest point. This function is convenient for carrying a camera on a strap because it prevents the lens from extending.

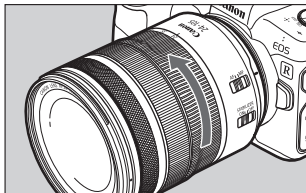
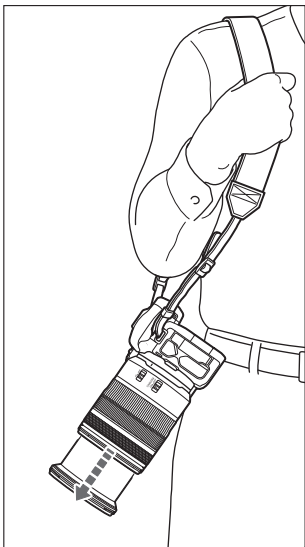

- 1 Turn the zoom ring to the widest position (24 mm).

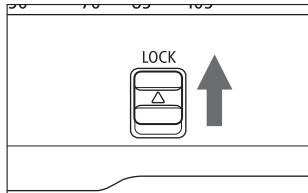

- 2 Slide the zoom ring lock lever in the direction indicated by the arrow.
 - To release the zoom ring, slide the zoom ring lock lever in the direction opposite to the arrow.

- The zoom ring cannot be fixed in place at any position other than the widest position.

5. Control Ring

The control ring can be assigned the functions that are commonly used with cameras, such as shutter speed and aperture settings.

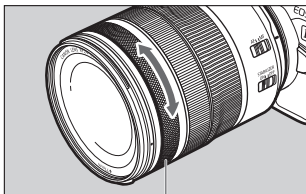

Control ring

The click action of the control ring allows you to have a sense of how much it is being turned. Please refer to the camera's instructions for details on how to use the control ring.



- There are cases in which the sound of control ring operations may be recorded when shooting movies.



- The clicking sensation of the control ring can be removed by the Canon Service Center. (chargeable)

6. Image Stabilizer

This function provides image stabilization appropriate for shooting conditions (such as shooting still subjects and panning shots).

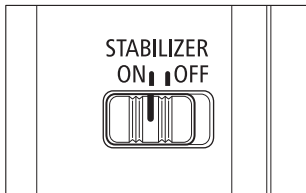

Set the image stabilizer switch to ON when you want to use the Image Stabilizer.

- Set the image stabilizer switch to OFF when you are not going to use the Image Stabilizer.

- The Image Stabilizer cannot compensate for a blurred shot caused by a subject that moved.
- The Image Stabilizer may not be fully effective if you shoot from a violently shaking vehicle or other transportation.
- The Image Stabilizer operates for about two seconds after turning off the camera. Do not detach the lens during that time. This may cause the lens to malfunction.
- When using a tripod, it is recommended that you set the image stabilizer switch to OFF.
- Even with a monopod, the Image Stabilizer will be as effective as during hand-held shooting. However, depending on the shooting conditions, there are cases in which the Image Stabilizer effect may be less effective.

- When shooting a still subject, it compensates for camera shake in all directions.
- It compensates for vertical camera shake during panning shots in a horizontal direction, and compensates for horizontal camera shake during panning shots in a vertical direction.

Image Stabilizer

The Image Stabilizer for this lens is suited to hand-held shots in the following conditions.



- In semi-darkened areas such as indoors or outdoors at night.
- In locations where a flash cannot be used, such as art museums and theater stages.
- In situations where your footing is uncertain.
- In situations where fast shutter speed settings cannot be used.



- Panning shots of vehicles, trains, etc.

7. Hood

The custom lens hood cuts out unwanted light and protects the front of the lens from rain, snow, and dust.

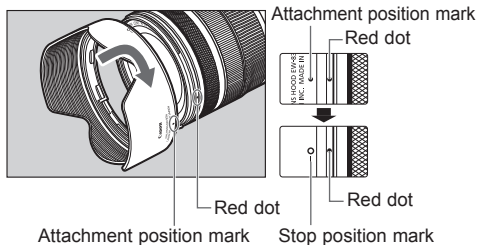

● Attaching the Hood

Align the red attachment position mark on the hood with the red dot on the front of the lens, and then turn the hood in the direction of the arrow until you hear a click.

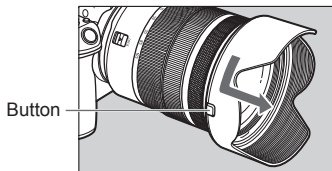

● Detaching the Hood

Keep your finger pressed down on the button located on the side of the hood, and then turn the hood in the direction of the arrow until the attachment position mark on the hood is aligned with the red dot on the front of the lens to detach it.

The hood can be reverse-mounted on the lens for storage.

- If the hood is not attached properly, vignetting (darkening of the perimeter of the picture) may occur.
- Grasp and turn the base of the hood when attaching and detaching it. There are cases in which it may become deformed if the hood is turned with it grasped near to the rim.

8. Filters (Sold separately)

You can attach filters to the filter mounting thread on the front of the lens.



- Only one filter may be attached.
- If you need a polarizing filter, use the Canon Circular Polarizing Filter PL-C B.
- Detach the hood when adjusting the polarizing filter.

9. Close-up Lenses (Sold separately)

Attaching a 500D Close-up Lens enables close-up photography.

It provides a magnification of 0.05x to 0.39x.



- Close-up Lens 250D cannot be attached because there is no size that fits the lens.
- MF mode is recommended for accurate focusing.

Specifications

Focal Length/Aperture	24-105mm f/4
Lens Construction	14 groups, 18 elements
Minimum Aperture	f/22
Angle of View	Horizontal: 74° - 19° 20', Vertical: 53° - 13°, Diagonal: 84° - 23° 20'
Min. Focusing Distance	0.45 m/1.48 ft.
Max. Magnification	0.24x (at 105 mm)
Field of View	Approx. 539 x 353 - 143 x 96 mm/ 21.22 x 13.90 – 5.63 x 3.78 in. (at 0.45 m/1.48 ft.)
Filter Diameter	77 mm
Max. Diameter and Length	83.5 x 107.3 mm/3.29 x 4.22 in.
Weight	Approx. 700 g/24.69 oz.
Hood	EW-83N
Lens Cap	E-77 II
Case	LP1319

- The lens length is measured from the lens mount surface to the front end of the lens.
Add 24.2 mm/0.95 in. when including the lens cap and dust cap.
- The maximum diameter, length and weight listed are for the lens itself only.
- All data listed is measured according to Canon standards.
- Product specifications and appearance are subject to change without notice.

Canon