

# MKE 400

Bedienungsanleitung  
Instructions for use  
Notice d'emploi  
Istruzioni per l'uso  
Instrucciones de uso  
Gebruiksaanwijzing

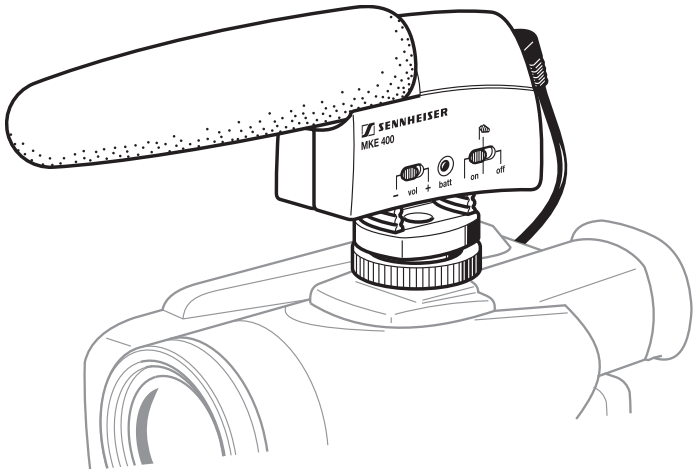



# The MKE 400

## Important safety information

Keep liquids (such as rain, etc.) away from the microphone!

## Features

- Rugged all-metal housing
- Maximal rejection of side noise, designed for use on film and video cameras/ camcorders
- Volume switch adjusts the sensitivity to cope with varying distances from the sound source
- Switchable low-cut filter minimizes wind noise
- More than 300 hours operating time (with only one AAA size battery)
- Integrated shock mount ensures effective suppression of handling and camera noise

## Operating elements

- 1 Microphone with removable windshield
- 2 “vol” switch
- 3 “batt” LED
- 4 “on/off” switch
- 5 Flashmount adapter with mounting thread
- 6 Knurled washer
- 7 Battery compartment catch

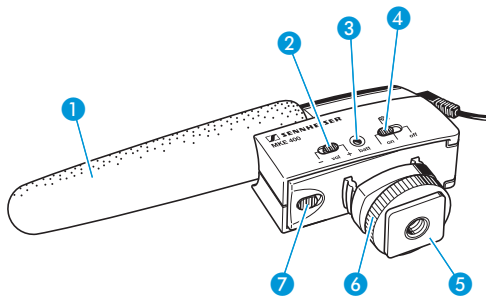

## Delivery includes

- 1 MKE 400 camera/ camcorder microphone with connection cable (3.5 mm stereo jack plug)
- 1 AAA size battery
- 1 foam windshield

## Inserting/ replacing the battery

If the battery voltage is sufficient, the “batt” LED ③ flashes briefly when you switch on the microphone. A new, unused battery has an operating time of approx. 300 hours.

When the battery voltage decreases, the “batt” LED ③ lights up permanently. You should replace the battery. When the “batt” LED ③ lights up permanently for the first time, the remaining operating time is approx. 50 hours.

---

**Note:** When not using the microphone for extended periods of time, remove the battery from the battery compartment!

---

To insert or replace the battery:

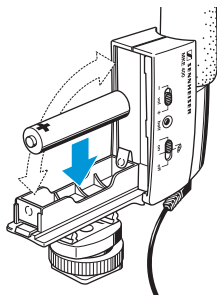

- ▶ Push the catch of the battery compartment ⑦ in the direction of the flashmount adapter and open the battery compartment.
- ▶ Insert the AAA size battery as shown in the diagram on the right. Observe correct polarity when inserting the battery.
- ▶ Close the battery compartment until the catch ⑦ locks into place.



## Putting the microphone into operation

- ▶ Slide the microphone onto the video camera's flashmount and lock the microphone by screwing down the knurled washer ⑥.
- ▶ Insert the 3.5 mm stereo jack plug into the microphone input socket of the video camera.

- ▶ Switch the microphone on by setting the “on/off” switch **4** to one of the two positions:

“on/ off”	Setting
	switched on (linear frequency response)
	switched on (low-cut filter is activated for minimizing wind noise)

On switch-on, the “batt” LED **3** flashes briefly, indicating that the battery is operational.

**Note:** When you have finished using the microphone, it is vital that you switch it off by setting the “on/off” switch **4** to the “off” position!

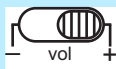

- ▶ Adjust the microphone sensitivity to the volume of the sound source and to the input sensitivity of the camera/camcorder by setting the “vol” switch **2** to the correct position:

“vol”	Setting
	Normal sensitivity: for normal or very loud sound sources and cameras/ camcorders with high input sensitivity
	High sensitivity: for extremely quiet or very distant sound sources and cameras/camcorders with low input sensitivity

## Specifications

	“vol” switch in position –	“vol” switch in position +
Dimensions (W x H x D)	approx. 130 x 21 x 62 mm	
Weight (without battery)	approx. 60 g	
Pick-up pattern	super-cardioid/lobar	
Frequency response	40 Hz to 20 kHz with and without windshield	
Sensitivity	8 mV/ Pa	20 mV/ Pa
Max. sound pressure level	126 dB	118 dB
Equivalent noise level	21 dB (A), 32 dB (CCIR)	16 dB (A), 25 dB (CCIR)
Power supply	1.5 V AAA size battery	
Operating time	approx. 300 hours	
Helical cable	length: approx. 200 mm diameter: 2.3 mm with 3.5 mm stereo jack plug	

## Recommended accessory

Professional accessory kit MZW 400 including hairy cover and 3-pin XLR adapter

# Manufacturer declarations

## Warranty

2 years

## Approval

 Sennheiser electronic GmbH & Co. KG declare that this device is in compliance with the applicable CE standards and regulations.

## Batteries or rechargeable batteries



Please dispose of batteries or rechargeable batteries as special waste or return them to your specialist dealer.

## WEEE Declaration



Please dispose of this product at the end of its operational lifetime by bringing it to your local collection point or recycling centre for such equipment.

## Frequenzkurve und Richtdiagramm

### Frequency response and polar pattern

### Réponse en fréquence et diagramme de la directivité

### Risposta in frequenza e diagramma polare

### Respuesta en frecuencia y diagrama de la directividad

### Frequentie-ingangen en Pooldiagramm

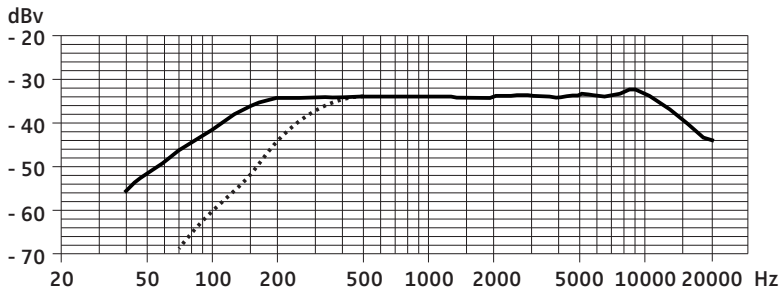

.....  Low Cut Filter

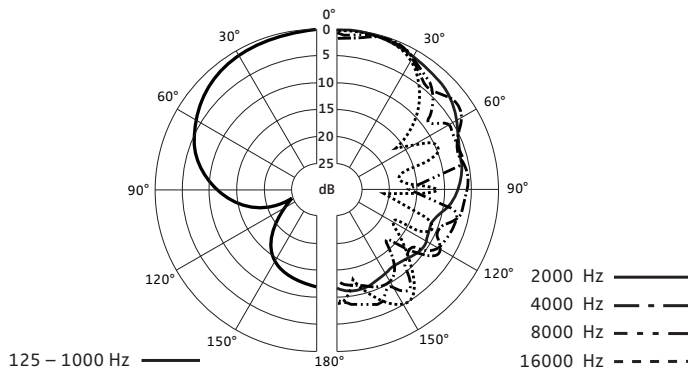



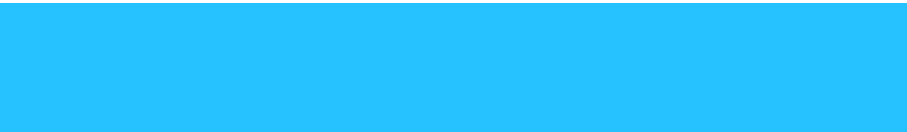

[www.maxlight.ru](http://www.maxlight.ru)

Sennheiser electronic GmbH & Co. KG

30900 Wedemark, Germany

Phone +49 (5130) 600 0

Fax +49 (5130) 600 300

[www.sennheiser.com](http://www.sennheiser.com)