

USER MANUAL

ODYSSEY 7Q+



convergent
design

HDMI™
HIGH-DEFINITION MULTIMEDIA INTERFACE

ProRes

Apple ProRes 4444 (XQ)
Apple ProRes 4444
Apple ProRes 422 (HQ)
Apple ProRes 422
Apple ProRes 422 (LT)

4K

Contents

INTRODUCTION	2
PACKAGE CONTENTS	3
OVERVIEW	4
Features	4
Specifications	5
RECORDING CAPABILITIES	6
Included Free with Odyssey7Q+	6
Odyssey RAW Bundle (<i>available online</i>)	7
Multicamera Options (<i>upgrade, available online</i>)	8
RECORD TIME CAPACITIES	9
Apple ProRes & Uncompressed DPX	9
RAW Recording Formats	10
Apollo Recording Formats	12
RECORDING OPTION RENTALS	13
Rental Activation Keys	13
Parameters for Rentals	13
SSD MEDIA	14
Qualified SSD Media	14
SSD Handles	14
ODYSSEY ANATOMY	15
Physical Characteristics	15
Mechanical Drawings	17
ODYSSEY REMOTE TRIGGER	18
GETTING STARTED	19
Odyssey Activation	19
Initializing	19
Powering Down	20
Setting Up & Using the Odyssey	20
The Odyssey Menu	20
Demo Mode (Watermarked)	20
MENU SYSTEM	21
Odyssey  Menu	21
Upper Tool Bar (Record Mode)	22
Upper Tool Bar (Play Mode)	38
Lower Tool Bar (Play Mode)	
Multistream Quad-HD Monitoring	39
Apollo Mode Recording	39
Apollo Dual-4K	39
Apollo Quad-HD	40
Quad-HD Recording	42
Quad-HD Live Switching and Live Switch Recording	45
Playback	46

Switching (Live Viewing)	47
Offloading	47
Quicktime Player Pro 7	47
CD Apple ProRes Transfer Tool	47
Using the CD ProRes Transfer Tool with Apollo Mode Files	49

WORKING WITH MEDIA **52**

Recording to SSD Media	52
Loss of Power During a Record	52
Downloading Media	52
OTHER FILES ON SSD MEDIA	52
File Storage	53

SOFTWARE UTILITIES **54**

CD Data Unpacker	54
CD Clip Merger	54
CD Apple ProRes Transfer Tool	54
CD 3D-LUT Converter	56

POST PRODUCTION **57**

Working with Recorded Files	57
Uncompressed Support (DPX sequence)	57
Apple ProRes	58
FS5/FS7/FS700 RAW Support (DNG Sequences)	59
FS5/FS7/FS700 RAW in DaVinci Resolve, Premiere, & Importing	
3D-LUTs	59
Canon C500/C300mkII 4K RAW Support	59
ARRI Alexa ARRIRAW Support	59

ACCESSORIES **60**

Convergent Design Accessories	60
Third Party Accessories	62

RELEASE NOTES **63**

Firmware Version 2016.06	63
Firmware Version 2016.01	66
Earlier Versions	67

LIMITED WARRANTY **68**

APPENDIX **69**

Monitor/Record Options	69
Online Resources	70

Convergent Design, Inc.
4525 Northpark Drive
Colorado Springs, CO 80918

Tel: ++(720)221-3861

Email: CDSupport@convergent-design.com

Website: Convergent-Design.com





BEFORE YOU BEGIN USING THE ODYSSEY, WE STRONGLY SUGGEST YOU REVIEW THE INCLUDED QUICK START GUIDE. WE ALSO STRONGLY RECOMMEND THE FOLLOWING:

1. Always record to the INTERNAL MEDIA OF THE CAMERA; this is critical for proper timecode and ideal for dual media / backup.
2. DO NOT REMOVE THE FOUR SCREWS FROM REAR OF CASE. This may result in damage to the OLED panel. Such damage is not covered by warranty.
3. Power and Cabling: Make sure you have PROPER POWER (6.5-34VDC), plugged in to the proper power port (left side of recorder), and that 3G-rated SDI cables are used.
4. Power source must be able to provide up to 24 watts at all times to the Odyssey.
5. When powering the Odyssey from an ARRI ALEXA camera, we recommend using the 24V R/S Fischer-3 output from the ALEXA using the optional Convergent Design cable.
6. Familiarize yourself with the equipment and test prior to shooting.
7. Before using the SSDs it is IMPERATIVE TO FORMAT them in the Odyssey. Formatting SSD media is a DESTRUCTIVE PROCESS; any existing data will be lost during format.
8. Ensure that the camera's viewfinder data is not being recorded; IF YOU SEE VIEWFINDER DATA ON THE ODYSSEY monitor, then it will be recorded! In a future update, if your camera can provide both clean and data-overlaid video feeds, it will be possible to monitor one while recording the other.
9. NEVER DELETE ANY FILES OFF AN SSD FROM A COMPUTER, except when going through a firmware update procedure.
10. While we recommend that you always maintain the latest firmware on your Odyssey, WE DO NOT RECOMMEND UPDATING FIRMWARE IF YOU ARE IN THE MIDDLE OF A SHOOT (unless specifically instructed to do so by our Technical Support staff).
11. When offloading media, ALWAYS MAKE A BACKUP COPY, ideally to a RAID1 drive.
12. Be sure to allow the Odyssey to finish closing a Record file before taking any further action.
13. Always safely eject SSD Media by pressing the  button before removing SSD media from the Odyssey.

Package Contents

Included with Odyssey7Q+

- Odyssey7Q+ Monitor/Recorder
- USB3 to SATA Adapter
- 5-Pack Odyssey SSD Handles
- Odyssey Universal Power supply
- Mini-to Micro HDMI Adapter.
- 36" HDMI Cable
- 36" 3G-SDI Cable

SSD Media and other accessories are sold separately.





Apple ProRes 4444 (XQ)
Apple ProRes 4444
Apple ProRes 422 (HQ)
Apple ProRes 422
Apple ProRes 422 (LT)



Features

Monitoring

PROFESSIONAL MONITOR: 7.7" 1280x800 OLED panel featuring true blacks, and accurate color with a full range color gamut for REC709 or DCI-P3 viewing.

IMAGE ANALYSIS TOOLS: Waveform, Vectorscope, Histogram, False Color exposure view, Zebra, Spot Meter, three-mode Focus Assist, Pixel Zoom (up to 12:1), LUTs, and Frame Guides.

MULTI-STREAM MONITORING: up to four HD video signals can be input and viewed simultaneously (quad-split) or live-switched (choose between inputs for full screen display). The Apollo Option for Odyssey allows recording of four HD video signals simultaneously along with a fifth channel of a Quad-Split view or a Live-Switch, all in Apple ProRes (HQ, 422, LT). The Apollo Option can also record two 4K/UHD video signals simultaneously.

FLEXIBLE I/O: two dedicated 3G-SDI inputs, two dedicated 3G-SDI outputs, two switchable 3G-SDI input/outputs, one HDMI input, one HDMI output. Active Cross-Conversion means that all outputs are always active regardless of which input is used.

Recording

HIGH-CAPACITY RECORDING: Two high-speed solid state Drives (SSD), available in 128GB, 256GB, 512 GB and 1TB capacities allow for extended recording.

4K / UHD / 2K / HD VIDEO RECORDING: Record 4K (4096x2160), UHD (3840x2160), 2K (2048x1080) and HD (1920x1080, 1280x720) Video in Apple ProRes 422 (HQ).

The Odyssey7Q+ can record 4K/UHD 10-bit or 1080p60 10-bit over HDMI.

2K / HD 4:4:4 RGB VIDEO RECORDING: Record 2K (2048x1080) and HD (1920x1080) video up to 50p/59.94p in 12-bit or 10-bit in uncompressed DPX stacks, Apple ProRes 4444(XQ) or Apple ProRes 4444.

ODYSSEY APOLLO OPTION (Upgrade): Optional upgrade that enables multistream recording of up to four simultaneous 1080p signals or two simultaneous 4K30 signals with live-switching and more.

[Visit Convergent-Design.com/apollo](http://Convergent-Design.com/apollo) for more information

RAW RECORDING (Upgrade): Optional recording features upgrade available at any time for purchase ([Odyssey RAW Bundle](#)) or daily rental (for individual record option licenses).

Odyssey RAW Bundle Includes:

- ARRIRAW (ALEXA)
- CANON RAW (C500, C300mkII)
- SONY RAW (FS5/FS7/FS700)
- POV RAW (Indiecam and IO Industries cameras)

[Visit Convergent-Design.com/odyssey-upgrades/raw-recording](http://Convergent-Design.com/odyssey-upgrades/raw-recording)

Specifications

Display	7.7" OLED, 1280x800, RGB 8-bit panel, ~ 16 million colors, wide gamut, 3400:1 contrast, 176° viewing, true blacks
SDI Video I/O	HD-SDI / 1.5G / 3G / 6G support: Single/Dual/Quad Link inputs (HD/2K/Ultra-HD & 4K supported), Dual HD-SDI 1.5G outputs, Full-size BNCs
HDMI Video Input	HDMI I/O Version 1.4a support, 10-bit 422, up to 1080p60, up to 30fps in Ultra-HD (3840 x 2160) and up to 24fps in 4K (4096 x 2160)
HDMI Video Output	HDMI I/O Version 1.4a support, 8-bit 422, up to 1080p30
LUT Support	LUTs for Log formats from ARRI, Blackmagic Design, Canon Panasonic and Sony, plus up to 140 custom 3D-LUTs in .CUBE format
Focus Assist	Adjustable peaking, edge detection, noise reduction, user choice of color: Red, Green, Blue, Black, White, or Yellow
Zebra	Dual adjustable zebra exposure indicators, selectable colors
False Color	False Color with 6 programmable levels & adjustable ranges
Monochrome	Grayscale monitoring mode, view Luma or individual red, green or blue color channels
Waveform	Luma only, RGB Parade, Red only, Blue only, Green only, Full Size and Compact Size Options
Histogram	Luma only, RGB Parade, Red only, Blue only, Green only, Full Size and Compact Size Options
Spot Meter	Luma and Red/Green/Blue values, single spot, dual spot & 8-spot modes
Vectorscope	75% & 100% saturation color targets, analog or digital trace, green or true CbCr trace color, 1-15x magnification
Pixel Zoom	Image Magnification with frame drag, magnification factors of 1:1, 2:1, 4:1, 6:1, 8:1, 10:1, 12:1
Frame Adjust	Anamorphic Desqueeze, 17:9 letterbox, Automatic Image Flip (defeatable) , Programmable Aspect Ratio Guides
Multi-Stream Display	Display four independent 1080 or 720 HD streams simultaneously (Quad-split) with live-switch capability - 4 x SDI or 3 x SDI & 1 HDMI
Digital Audio I/O	8-channel SDI (4:2:2 video signals), 2-channel HDMI embedded audio (48KHz, 24-bit)
Analog Audio I/O	3.5mm port for line level 2-channel unbalanced or 1-channel balanced input up to -10dB, 48KHz, 24-bit, 3.5mm stereo headphone output, adjustable
Timecode	LTC I/O (BNC), embedded SDI / HDMI, internal clock
User Interface	Capacitive Touchscreen, three mechanical keys
DC Power Input	6.5 to 34VDC with built-in reverse polarity protection; locking power connector, built-in power switch
Power Draw	8 watts (monitor only), 9 to 19 watts (depending on record mode)
Sound Level	Silent, no fan or vents
Weight and Size	560 grams / 1.2 lbs., 7.9" x 6.1" x 1.0" (200 x 155 x 25 mm)
Operating Temperature	-10 to +40°C (Operating) -20 to +70°C (Storage)
Output Downscaling	Output 1080p HD via HDMI or SDI from 4K/UHD source (allows for additional on-set monitoring)
Record Triggers	Touchscreen, SDI record trigger (ARRI, CANON, PANASONIC, RED, SONY), HDMI (SONY, CANON, PANASONIC), Timecode, Remote Cable (Optional Accessory), SDI embedded record trigger is passed through to SDI outputs
Recording Media (Dual SSD Slots)	Qualified Samsung 2.5" SSDs in 128GB, 256GB, 512GB and 1TB sizes, 420Mb/sec write, 500Mb/sec read speed, compatible with USB 3.0 and Thunderbolt Adapters. SSDs and adapters sold separately.
Recording Formats (422 video)	Apple ProRes 422 (HQ) / Apple ProRes 422 / Apple ProRes 422 (LT) 4K/UHD 10-bit YCC 422 up to 60 fps 2K/1080p 10-bit YCC 422 up to 60 fps 1080i 10-bit YCC 422 up to 60i 720p 10-bit YCC 422 up to 60 fps
Recording Formats (444 video)	Uncompressed DPX stacks 2K/1080p 12-bit RGB 444 up to 30 fps 2K/1080p 10-bit RGB 444 up to 60 fps Apple ProRes 4444 (XQ) / Apple ProRes 4444 2K/1080p 12-bit RGB 444 up to 60 fps 2K/1080p 10-bit RGB 444 up to 60 fps
Recording Formats (RAW data)	Odyssey RAW Bundle required ARRIRRAW (ALEXA Classic), Canon Cine RAW (C300 MK2, C500), Sony FSRAW (FS5, FS7, FS700) Indiegam RAW, IO Industries RAW

(Additional recording formats are available with the purchase of the Odyssey RAW Bundle)



Included Free with Odyssey7Q+

Video Recording	4K/UHD (4096x2160, 3840x2160): Apple ProRes (HQ/422/LT) / 23.98p, 24p, 25p, 29.97p, 30p, 50p, 59.94p, 60p
	2K/HD (2048x1080, 1920x1080): Uncompressed video in DPX stacks, 12-bit/10-bit 4:4:4 / 23.98p, 24p, 25p, 29.97p, 30p
	2K/HD (2048x1080, 1920x1080): Uncompressed video in DPX stacks, 10-bit 4:2:2 (recorded as 4:4:4) / 23.98p, 24p, 25p, 29.97p, 30p, 50p, 59.94p, 60p
	2K/HD (2048x1080, 1920x1080): Apple ProRes 4444 & 4444(XQ) / 23.98p, 24p, 25p, 29.97p, 30p, 50p, 59.94p, 60p
	2K/HD (2048x1080, 1920x1080): Apple ProRes (HQ/422/LT) / 23.98p, 24p, 25p, 29.97p, 50p, 59.94p, 60p, 50i, 60i
	HD (1280x720): Apple ProRes (HQ/422/LT) / 50p, 60p
	4K/UHD video over 6G-SDI, Dual-Link 3G-SDI, Quad-Link 3G-SDI or HDMI
	4K/UHD Video over HDMI - supersampled to 2K/HD - Recorded as Apple ProRes
	4K Video over HDMI up to 24p, UHD Video over HDMI up to 30p - 10-bit
	2K/HD video over SDI up to 60p
	HD (1080) over HDMI up to 60p; HD (720) over HDMI up to 60p
MULTI-STREAM HD Video Monitoring	SDI and HDMI accepted 1080p/psf / 23.98, 24, 25, 29.97, 30, 50i, 60i
	SDI and HDMI accepted 720p / 50, 60
	<i>Note: This is a monitoring mode only. Use Apollo Option for Multi-Stream Recording in HD and 4K.</i>
	Display four independent 1080 or 720 HD streams simultaneously (Quad-split). Includes capability to mix 1080 & 720 signals.
	OLED display divided into quadrants or a single input may be selected for full screen display. Live-switch between inputs directly.
	Inputs are SDI A, SDI B, SDI A I/O, SDI B I/O and HDMI (signals auto-detected; [SDI A] must always be present).
	HD video signals do not need to be Genlocked.
HD video signals do not need to match frame rates or resolutions.	

Apple ProRes Recording

Odyssey7Q+ supports recording in Apple ProRes 4444 (XQ), Apple ProRes 4444, Apple ProRes 422 (HQ), Apple ProRes 422, and Apple ProRes 422 (LT). Files are saved in .MOV format.

ProRes

Apple ProRes 4444 (XQ)	12-bit 444 RGB recording at 500mbps 2K/HD
Apple ProRes 4444	12-bit 444 RGB recording at 330mbps 2K/HD
Apple ProRes 422 (HQ)	10-bit 422 YCC recording at 220mbps 4K/UHD/2K/HD
Apple ProRes 422	10-bit 422 YCC recording at 147mbps 4K/UHD/2K/HD
Apple ProRes 422 (LT)	10-bit 422 TCC recording at 100mbps 4K/UHD/2K/HD



Odyssey RAW Bundle *(available online)*

All recording option upgrades are available for demo on the Odyssey7Q+, but will appear with a blue or pink line watermark across the recorded image.

With the purchase of the [Odyssey RAW Bundle](#) as a permanent upgrade license or daily rental the Odyssey is capable of recording RAW output from certain cameras. With the purchase or daily rental of the [Odyssey Apollo Option](#) the Odyssey is capable of recording up to four HD or two 4K video Signals simultaneously.

Recording option upgrades are available to purchase as a permanent license or daily rental from the Convergent Design website at Convergent-Design.com/odyssey-upgrades.

Please note that record option upgrades (rental or purchase) are delivered in the form of activation keys that are specific to the unit for which they are purchased and cannot be transferred between units.

SONY FS RAW FS5 / FS7 / FS700 The Odyssey7Q/ Odyssey7Q+ support SONY FS RAW 4K & 2K RAW and high quality video derived from RAW. <i>(Available for purchase with the Odyssey RAW Bundle or daily rental)</i>	RAW Recording (FS 4K/2K RAW recorded as .DNG files) FS 4K RAW / 23.98, 25, 29.97, 50*, 59.94* FS 2K RAW / 23.98, 25, 29.97, 50, 59.94, 100, 119.88, 200*, 239.76*
	Apple ProRes Recording (derived from RAW camera output) FS 4K RAW -> 4K Apple ProRes / 23.98, 25, 29.97, 50, 59.94 FS 4K RAW -> UHD Apple ProRes / 23.98, 25, 29.97, 50, 59.94 FS 4K RAW -> 2K Apple ProRes / 23.98, 25, 29.97, 50, 59.94 FS 4K RAW -> HD Apple ProRes / 23.98, 25, 29.97, 50, 59.94 FS2K RAW High Speed -> 2K Apple ProRes / 100, 119.88, 200, 239.76 FS 2K RAW High Speed -> HD Apple ProRes / 100, 119.88, 200, 239.76
	440 Frame Burst Mode (FS5/FS700) FS 4K RAW 440 Frame Burst / 100*, 119.88* FS 4K RAW Burst -> 4K Apple ProRes / 100, 119.88 FS 4K RAW Burst -> UHD Apple ProRes / 100, 119.88 FS 4K RAW Burst -> 2K Apple ProRes / 100, 119.88 FS 4K RAW Burst -> HD Apple ProRes / 100, 119.88
	<i>* NOTE: High data rate of RAW at 4K50p, 4K59.94p, 4K100p burst, 4K119.88p Burst, 2K200p and 2K239.76p require recording to two SSDs simultaneously.</i>

[More Info: Convergent-Design.com/odyssey-upgrades/raw-recording](http://Convergent-Design.com/odyssey-upgrades/raw-recording)

ARRI ALEXA ARRIRAW The Odyssey7Q/ Odyssey7Q+ support all ARRIRAW formats and frame rates output by Alexa Classic cameras. <i>(Available for purchase with the Odyssey RAW Bundle or daily rental)</i>	ARRIRAW data is recorded as .ari files.
	ARRIRAW 16:9 / 23.98, 24, 25, 29.97, 30, 48*, 50*, 59.97*, 60*
	ARRIRAW 4:3 / 23.98, 24, 25, 29.97, 30, 48*
	*Future Firmware Update for 4:3 Support *NOTE: ARRIRAW above 30fps requires two SSDs to simultaneously record. In a future firmware update only one SSD will be required for all frame rates.

[More Info: Convergent-Design.com/odyssey-upgrades/raw-recording](http://Convergent-Design.com/odyssey-upgrades/raw-recording)

CANON Cinema RAW (C300mkII/C500) The Odyssey7Q & Odyssey7Q+ support CANON 4K Cine RAW. <i>(Available for purchase with the Odyssey RAW Bundle or daily rental)</i>	CANON Cinema RAW data is recorded as .RMF files.
	4K RAW to 4K Apple ProRes / 10-Bit / 23.98, 24, 25, 29.97, 30
	QHD RAW to UHD Apple ProRes / 10-Bit / 23.98, 24, 25, 29.97, 30
	Supported 4K/QHD RAW / 23.98, 24, 25, 29.97, 30, 50*, 59.94*, 60 4K Half RAW 50, 59.94, 100*, 120*
	2K/1080p 12-bit/10-bit 4:4:4 support / 23.98, 24, 25, 29.97
*NOTE: CANON RAW 50-60p and Half RAW 100-120p (both C500 only) require two SSDs to simultaneously record.	

[More Info: Convergent-Design.com/odyssey-upgrades/raw-recording](http://Convergent-Design.com/odyssey-upgrades/raw-recording)

Recording Capabilities

POV RAW Supports several industrial/special use cameras' RAW outputs. <i>(Available for purchase with the Odyssey RAW Bundle or daily rental)</i>	IO Industries Flare 4KSDI & 2KSDI: 2K/HD 10-Bit RAW / 23.98-60p
	Indiecam indieGS2K: 2K/HD 10-Bit RAW / 60-120p
	Indiecam indieGS2K: HD 10-Bit RAW / 23.98-60p
	Indiecam indieGS2K: HD 12-Bit RAW / 23.98-60p
	NOTE: RAW data is recorded as .DNG files.
NOTE: Video outputs do not require Record Option.	

[More Info: Convergent-Design.com/odyssey-upgrades/raw-recording](http://Convergent-Design.com/odyssey-upgrades/raw-recording)

Multicamera Options *(upgrade, available online)*

APOLLO OPTION (Multi-Camera Recording/Live Switching) Supports recording of four HD video streams simultaneously along with a fifth channel of a quad-split view or live-switch. Supports recording of two simultaneous 4K video streams.	<ul style="list-style-type: none"> • 1080p 24, 25, 30, 50, 60 / 1080i 50, 60 / 720p 50, 60 • All video streams must match in resolution and frame rate. • Live-Switch using OLED touchscreen or optional keypad. • Record four HD streams plus Live-Switch or Quad-View (up to 1080p30). • Record two 4K/UHD video streams simultaneously. • No genlock required; streams timecode matched. • Record in Apple ProRes (HQ/422/LT) • Output as matched clips or single multicamera file.
	Apollo Option for Odyssey available for purchase or daily rental from Convergent Design website. <i>NOT INCLUDED IN ODYSSEY RAW BUNDLE.</i> For detailed specifications, see the Apollo Option section of this manual. More Info: Convergent-Design.com/odyssey-upgrades/apollo-option

DUAL-HD Recording Supports recording of two HD video streams simultaneously. Included as part of Odyssey RAW Bundle.	<ul style="list-style-type: none"> • 1080p 24, 25, 30 / 1080i 50, 60 / 720p 50, 60 • Both video streams must match in resolution and frame rate. • Record in Apple ProRes (HQ/422/LT)
	Odyssey RAW Bundle available for purchase or daily rental from Convergent Design website.

Record Time Capacities

ProRes

ProRes 4444 (XQ)
 ProRes 4444
 ProRes 422 (HQ)
 ProRes 422
 ProRes 422 (LT)

Apple ProRes & Uncompressed DPX

The Odyssey can record numerous video and data formats such as Apple ProRes and uncompressed DPX, which are included free with the Odyssey. The chart below indicates maximum record time in minutes based on the use of two 512 GB SSDs (1TB). For 512 GB (one 512 GB SSD or two 256 GB SSDs), divide in half. For 256 GB, divide by four. For 2TB (two 1TB SSDs), multiply by two. Record time capacities vary based on format.

Recording Format	24fps	25fps	30fps	50fps	60fps
Apple ProRes 4444 (XQ) (Included FREE)					
2K Apple ProRes 4444 (XQ)	268	256	214	128	106
HD Apple ProRes 4444 (XQ)	288	278	230	138	114
Apple ProRes 422 (HQ) (Included FREE)					
2K Apple ProRes 4444	382	366	306	182	152
HD Apple ProRes 4444	412	396	330	198	164
Apple ProRes 422 (HQ) (Included FREE)					
4K Apple ProRes 422 (HQ)	157	151	126	76	63
UHD Apple ProRes 422 (HQ)	168	161	134	81	67
2K Apple ProRes 422 (HQ)	629	603	503	301	251
1080p Apple ProRes 422 (HQ)	670	643	536	322	268
1080i Apple ProRes 422 (HQ)				642	536
720p Apple ProRes 422 (HQ)				724	604
Apple ProRes 422 (Included FREE)					
4K Apple ProRes 422	220	212	176	106	88
UHD Apple ProRes 422	264	252	212	126	106
2K Apple ProRes 422	964	924	772	460	384
1080p Apple ProRes 422	1060	1016	848	508	424
1080i Apple ProRes 422				1016	848
720p Apple ProRes 422				924	772
Apple ProRes 422(LT) (Included FREE)					
4K Apple ProRes 422 (LT)	328	316	264	158	132
UHD Apple ProRes 422 (LT)	408	392	324	196	162
2K Apple ProRes 422 (LT)	1324	1272	1060	636	528
1080p Apple ProRes 422 (LT)	1516	1456	1212	728	604
1080i Apple ProRes 422 (LT)				1456	1212
720p Apple ProRes 422 (LT)				1456	1212
Uncompressed DPX (Included FREE)					
2K Uncompressed DPX (RGB 444 12-bit)	71	68	56		
2K Uncompressed DPX (RGB 444 10-bit)	78	74	62		
1080p Uncompressed DPX (RGB 444 12-bit)	75	72	60		
1080p Uncompressed DPX (RGB 444 10-bit)	83	79	66	40	33

Information provided for comparison purposes only. Features and specifications are subject to change without notice.

Record Time Capacities



RAW Recording Formats

With the purchase or rental of the Odyssey RAW Bundle (available from Convergent Design website) the Odyssey7Q+ is capable of recording RAW output from certain cameras. The chart below indicates maximum record time in minutes based on the use of two 512 GB SSDs (1TB). For 512 GB (one 512 GB SSD or two 256 GB SSDs), divide in half. For 256 GB, divide by four. For 2TB (two 1TB SSDs), multiply by two. Record time capacities vary based on format.

Recording Format	24fps	25fps	30fps	50fps	60fps	100fps	120fps	200fps	240fps
SONY RAW FS5/FS7/FS700 RAW Recording Option (Included in the Odyssey RAW Bundle or available for daily rental)									
FS 4K RAW	50	49	40	24	20				
FS 2K RAW	200	192	160	96	80	48	40	24	20
FS 4K RAW to 4K Apple ProRes 422 (HQ) "4K->4K"	157	151	126	76	63				
FS 4K RAW to UHD Apple ProRes 422 (HQ) "4K->UHD"	168	161	134	81	67				
FS 4K RAW to 2K Apple ProRes 422 (HQ) "4K->2K"	629	603	503	301	251				
FS 4K RAW to HD Apple ProRes 422 (HQ) "4K->HD"	670	643	536	322	268				
FS 4K RAW to 4K Apple ProRes 422 "4K->4K"	220	212	176	106	88				
FS 4K RAW to UHD Apple ProRes 422 "4K->UHD"	264	252	212	126	106				
FS 4K RAW to 2K Apple ProRes 422 "4K->2K"	964	924	772	460	384				
FS 4K RAW to HD Apple ProRes 422 "4K->HD"	1060	1016	848	508	424				
FS 4K RAW to 4K Apple ProRes 422 (LT) "4K->4K"	328	316	264	158	132				
FS 4K RAW to UHD Apple ProRes 422 (LT) "4K->UHD"	408	392	324	196	162				
FS 4K RAW to 2K Apple ProRes 422 (LT) "4K->2K"	1324	1272	1060	636	528				
FS 4K RAW to HD Apple ProRes 422 (LT) "4K->HD"	1516	1456	1212	728	605				
FS 2K RAW High Speed to HD Apple ProRes 422 (HQ) "2K->HD"						161	134	81	67
FS 2K RAW High Speed to HD Apple ProRes 422 "2K->HD"						254	212	127	106
FS 2K RAW High Speed to HD Apple ProRes 422 (LT) "2K->HD"						364	303	182	151
FS5/700 High Speed Burst Mode: 440 frames @ 100p (4.4s) or 120p (3.7s)									
FS 4K RAW Burst to 4K RAW (155 takes in 1TB)						12	10		
FS 4K RAW Burst to 4K Apple ProRes 422 (HQ)						37	31		
FS 4K RAW Burst to 4K Apple ProRes 422						57	48		
FS 4K RAW Burst to 4K Apple ProRes 422 (LT)						79	66		
FS 4K RAW Burst to UHD Apple ProRes 422 (HQ)						39	33		
FS 4K RAW Burst to UHD Apple ProRes 422						63	53		
FS 4K RAW Burst to UHD Apple ProRes 422 (LT)						91	75		
FS 4K RAW Burst to 2K Apple ProRes 422 (HQ)						148	124		
FS 4K RAW Burst to 2K Apple ProRes 422						228	192		
FS 4K RAW Burst to 2K Apple ProRes 422 (LT)						316	264		
FS 4K RAW Burst to HD Apple ProRes 422 (HQ)						156	132		
FS 4K RAW Burst to HD Apple ProRes 422						252	212		
FS 4K RAW Burst to HD Apple ProRes 422 (LT)						364	300		

Record Time Capacities



Recording Format	24fps	25fps	30fps	50fps	60fps	100fps	120fps	200fps	240fps
ARRI ALEXA Recording Option (Included in the Odyssey RAW Bundle or available for daily rental)									
ARRIRAW 16:9	90	87	72	43	36				
CANON Cine RAW (C300mkII/C500) Recording Option (Included in the Odyssey RAW Bundle or available for daily rental)									
Canon 4K RAW	56	54	45	27	23	30	25		
Canon 4K Half RAW				54	45	27	23		
Canon QHD Raw	60	58	48	29	24				
Canon 4K RAW to 4K Apple ProRes 422 (HQ)	157	151	126						
Canon QHD RAW to UHD Apple ProRes 422 (HQ)	168	161	134						
Canon 4K RAW to 4K Apple ProRes 422	220	212	176						
Canon QHD RAW to UHD Apple ProRes 422	264	252	212						
Canon 4K RAW to 4K Apple ProRes 422 (LT)	328	316	264						
Canon QHD RAW to UHD Apple ProRes (LT)	408	392	324						
POV RAW Recording Option (Included in the Odyssey RAW Bundle or available for daily rental)									
POV 2K 10-bit RAW	252	242	202	121	101				
POV HD 10-bit RAW	269	258	215	129	107	64	54		
POV HD 12-bit RAW	222	213	178	106	89				

Record Time Capacities



Apollo Recording Formats

Recording Format	24fps	25fps	30fps	50fps	60fps
Apple ProRes 422 (HQ)					
5-Track (A/B/C/D + QS or LS) 1080p Apple ProRes 422 (HQ)	134	128	107		
5-Track (A/B/C/D + QS or LS) 1080i Apple ProRes 422 (HQ)				128	107
5-Track (A/B/C/D + QS or LS) 720p Apple ProRes 422 (HQ)				144	120
4-Track (A/B/C/D) 1080p Apple ProRes 422 (HQ)	167	160	134		
4-Track (A/B/C/D) 1080i Apple ProRes 422 (HQ)				160	134
4-Track (A/B/C/D) 720p Apple ProRes 422 (HQ)				181	151
Apple ProRes 422					
5-Track (A/B/C/D + QS or LS) 1080p Apple ProRes 422	212	203	169		
5-Track (A/B/C/D + QS or LS) 1080i Apple ProRes 422				203	169
5-Track (A/B/C/D + QS or LS) 720p Apple ProRes 422				184	154
4-Track (A/B/C/D) 1080p Apple ProRes 422	265	254	212		
4-Track (A/B/C/D) 1080i Apple ProRes 422				254	212
4-Track (A/B/C/D) 720p Apple ProRes 422				231	193
Apple ProRes 422(LT)					
5-Track (A/B/C/D + QS or LS) 1080p Apple ProRes 422 (LT)	303	291	242		
5-Track (A/B/C/D + QS or LS) 1080i Apple ProRes 422 (LT)				291	242
5-Track (A/B/C/D + QS or LS) 720p Apple ProRes 422 (LT)				328	220
4-Track (A/B/C/D) 1080p Apple ProRes 422 (LT)	379	364	303		
4-Track (A/B/C/D) 1080i Apple ProRes 422 (LT)				364	303
4-Track (A/B/C/D) 720p Apple ProRes 422 (LT)				410	275
APOLLO DUAL-4K Apple ProRes 422 (HQ)					
2-Track (A/B) 4K Apple ProRes 422 (HQ)	78	75	63		
2-Track (A/B) UHD Apple ProRes 422 (HQ)	84	80	67		
APOLLO DUAL-4K Apple ProRes 422					
2-Track (A/B) 4K Apple ProRes 422	110	106	88		
2-Track (A/B) UHD Apple ProRes 422	132	126	106		
APOLLO DUAL-4K Apple ProRes 422 (LT)					
2-Track (A/B) 4K Apple ProRes 422 (LT)	164	158	132		
2-Track (A/B) UHD Apple ProRes 422 (LT)	204	196	162		

[More Info: Convergent-Design.com/odyssey-upgrades/apollo-option](http://Convergent-Design.com/odyssey-upgrades/apollo-option)



Rental Activation Keys

Rental Activation Keys may be purchased through our website for the Odyssey RAW Bundle (Sony FS RAW (FS5/FS7/FS700), Canon Cinema RAW (C500/C300mkII), ARRI Alexa ARRIRAW, POV RAW, and Dual-HD Recording) and Apollo Multi-Stream options. Please visit the links in the Recording Capabilities section for more information.

Parameters for Rentals

Rentals are based on a 24 hr period, Rentals can be added to the unit in daily (24 hour) increments up to a maximum of 30 days at a time.

A rental starts the first time a record is performed in the rental codec, then the 24 hour clock starts.

Note that during a 24 hr rental period you will not be allowed to adjust the clock after the first record. Thus users must set a central time, or choose a timezone that will best fit all of their given locations in that 24 hr period.

- After 24 hours a user may adjust the clock as needed, till the next record is performed.
- Rentals are unit specific, by the unit serial number, and must be purchased via our website. Once a rental key is input into a unit, there is no way of retrieving or transferring the rental to another unit.
- To activate a rental simply enter the 8 character key into the unit's activation section.
- To check the status of an active rental touch the codec box.
- When a rental period has two days remaining, the rental text will change to yellow.
- When a rental period has one day remaining, the time will display in the form of minutes and will be flash for the last hour.
- When there is one minute remaining, if a record is started, that entire clip will be recorded without a watermark regardless of length up to a maximum of 80 mins. (In other words, will let you finish your last take, which can be a maximum of filling up both drives, based on a RAW format.
- After the final clip the time remaining will change back to a white 0 mins.

For more information or to purchase Rental Options please visit our the Odyssey Upgrades page of our website at Convergent-Design.com/odyssey-upgrades

For support with Rental Options visit us online at Convergent-Design.com/support

Qualified SSD Media

THE ODYSSEY7Q+ REQUIRES THE USE OF SPECIFIC SSDS FOR RECORDING, WHICH MUST BE PURCHASED SEPERATELY TO ENABLE RECORDING. SSDs mount into the Odyssey monitor/ recorders with a latching handle. A five-pack kit of SSD handles is included with the Odyssey7Q+ and additional SSD handle kits are available for purchase separately. SSDs sold by Convergent Design ship with handles installed.

QUALIFIED SAMSUNG SSDS

Select models of Samsung SSDs are available from Convergent Design with a CD 10-year warranty. Additional models of qualified Samsung SSDs are available for purchase on the commercial market. Any other media mounted into an Odyssey monitor/recorder will trigger an “Unsupported Media” notice with recording unavailable.

Samsung 2.5” 850 PRO series in 128GB, 256GB, 512GB, and 1TB
Samsung 2.5” 850 EVO series in 1TB

CONVERGENT DESIGN WARRANTIED SAMSUNG SSDS

Convergent Design Odyssey SSDs may also be used. Odyssey SSDs are available in 256GB, 512GB and 1TB. Odyssey SSDs may be available for purchase form dealers, but have been discontinued and are no longer manufactured by Convergent Design.

CD/Samsung 2.5” 850 PRO 256GB	CD-SSD-256GB
CD/Samsung 2.5” 850 PRO 512GB	CD-SSD-512GB
CD/Samsung 2.5” 850 PRO 1TB	CD-SSD-1TB

WARRANTIED VS. QUALIFIED SSD MEDIA

SSDs sold by Convergent Design through our authorized dealers are certified to work in Odyssey monitor/recorders. Convergent Design tests and sells these SSDs, so the company has oversight to warranty their performance. All of the above-listed Samsung SSDs are qualified to work in Odyssey monitor/recorders. But if we do not directly sell this media Convergent Design cannot warranty individual third-party sold SSDs. Convergent Design Customer Support is available to our clients 24/7, but we may not be able to successfully support third-party product to the same extent as our own products.

SSD FOR FIRMWARE UPDATES

Convergent Design periodically issues firmware updates for the Odyssey7Q+, improving and adding functions. Any of the above-listed Samsung SSDs can be used to load firmware updates.

CONVERGENT DESIGN SSD TO USB 3.0 ADAPTER

To connect an SSD to a computer for downloading files, the computer needs to be able to mount an eSata 2.0 connection. For computers without such connectivity, the Convergent Design SSD to USB 3.0 Adapter is an inexpensive cable-style adapter to allow the SSD to connect to a USB 3.0 port. 6Ghz transfer speed. The Convergent Design USB3.0 Adapter is powered fully by the USB 3.0 connection and supports all SSDs allowed for use with Odyssey and Apollo devices. An SSD to USB 3.0 Adapter is included with the Odyssey7Q+ and Apollo. Additional units are available for purchase.

Convergent Design SSD to USB Adapter: CD-SSD-USB3-ST

NOTE: While the Convergent Design USB 3.0 Adapter can be connected to a USB 2.0 port, download speeds will be extremely slow, requiring many hours to offload an SSD.

SSD Handles

A five-pack kit of SSD handles is included with the Odyssey7Q+ monitor/recorder and additional SSD handle kits are available for purchase separately.

Physical Characteristics

Odyssey7Q+ - Bottom

There are eleven connector ports on the bottom side of the Odyssey7Q+ (left to right)



PWR ON	Power input socket to Odyssey (see Getting Started – Power). Just in front of the PWR ON port is a button, which is a Force Power On/Off control. Hold button five seconds to force power off. This is only to be used if standard power on or off procedures fail (see Getting Started – Initializing).
SDI A IN	BNC connector for 6G-SDI input A
SDI B IN	BNC connector for 6G-SDI input B
LTC IO	BNC connector for Linear Timecode input/output
SDI A IO	BNC connector for 3G-SDI input/output A. In Multi-Stream monitoring mode, the Odyssey can accept up to four HD video inputs. These IO ports allow additional inputs or additional outputs for the Odyssey.
HDMI OUT	Output 1920x1080 to HDMI device.
SDI B IO	BNC connector for 3G-SDI input/output B. In Multi-Stream monitoring mode, the Odyssey can accept up to four HD video inputs. These IO ports allow additional inputs or additional outputs for the Odyssey.
SDI A OUT	BNC connector for 3G-SDI output A
SDI B OUT	BNC connector for 3G-SDI output B
AUDIO IN	3.5mm mini-phone stereo socket for analog audio in.
AUDIO OUT	3.5mm mini-phone stereo headphone socket.

Odyssey7Q+ - Top

There are two Solid State Drive (SSD) slots, SSD1 and SSD2.



Only Convergent Design Odyssey SSDs or certain Qualified Samsung SSDs can be up with the Odyssey7Q+. To mount SSD, insert connector-end first with the label facing forward and the handle near flush with the back of the Odyssey. Push gently but firmly until the handle flange is flush with the top of the Odyssey. It is a snug fit, but the SSD should insert smoothly.

Odyssey7Q+ - Left Side

There are two Function buttons, F1 LOCK and F2 SHUT DOWN.



F1 LOCK

Lockout control for the Odyssey touchscreen. Push to engage and SCREEN LOCK will appear in the center of the touchscreen's Upper Tool Bar. Push F1 again to disengage. Engaging F1 also re-calibrates the touchscreen.

F2 SHUT DOWN

Preferred method to power down the Odyssey. Properly closes files on the SSDs and performs other maintenance functions (see Getting Started -- Powering Down). Push to activate prompt asking SAFELY POWER DOWN UNIT? *In a future free firmware update it will be possible to program these buttons for additional functions.*

Odyssey7Q+ - Right Side

There are three connector ports, (top to bottom) USB, HDMI OUT and RMT.



USB

An access point for servicing by Convergent Design.

HDMI IN

HDMI 1.4a (Mini HDMI) input port

RMT

A remote control connection to the Odyssey.
In a future free firmware update the RMT port will allow control interface with functions of the Odyssey.

KENSINGTON LOCK PORT

A rectangular hole above the RMT port is for accepting a Kensington Security Lock.

Mounting

The Odyssey features three ¼-20 threaded sockets, one on the lower rear of the case and one each on the left and right sides of the case. Do not exceed 11mm of depth when inserting a bolt, otherwise damage may occur to the Odyssey. Additionally, there are four M3 threaded sockets on the rear of the case and two M4 sockets on each of the sides of the case.

Mechanical Drawings

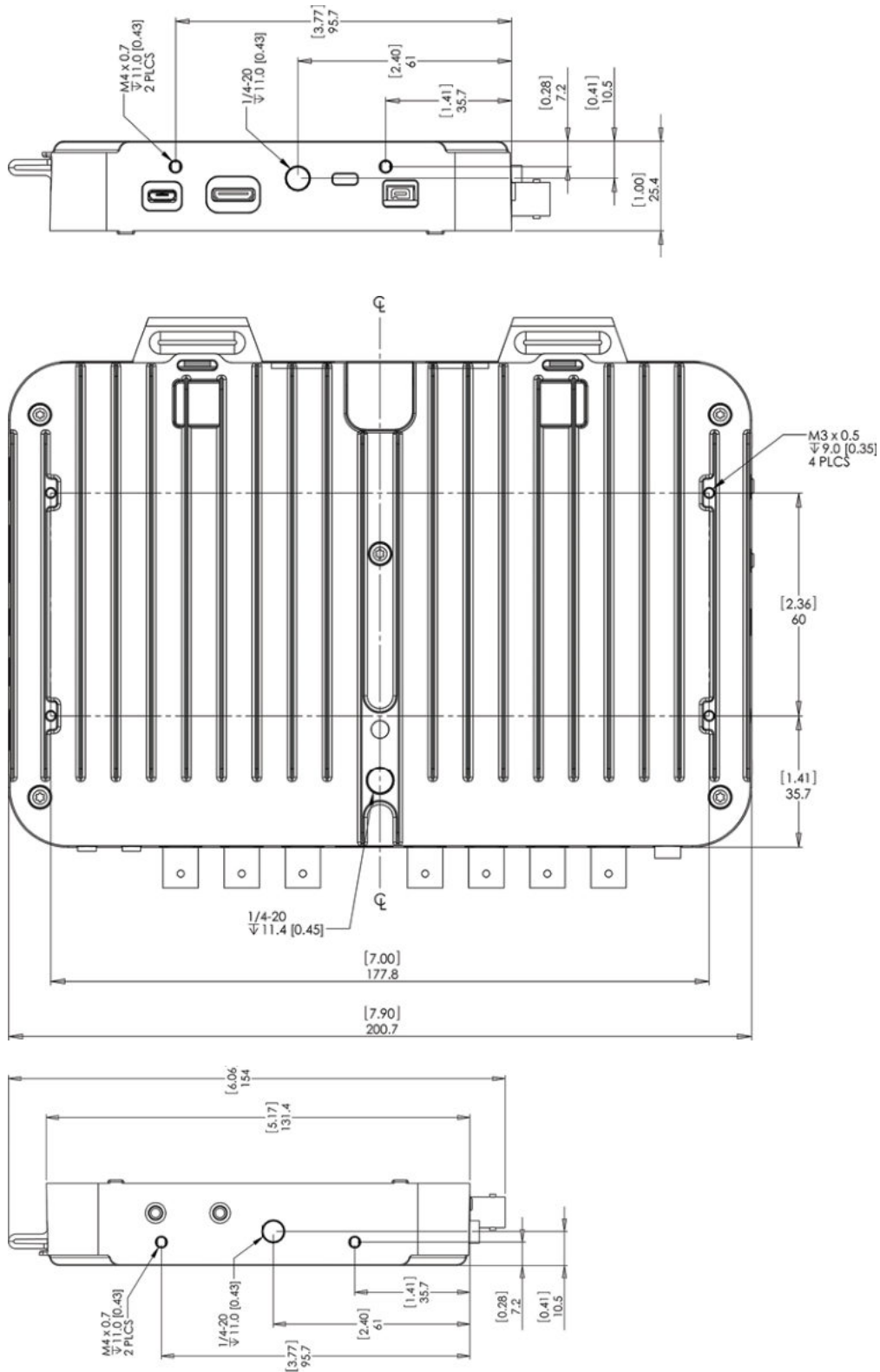

Odyssey Remote Trigger

The Convergent Design Odyssey Remote Trigger is a pushbutton active remote start/stop trigger for Odyssey monitor/recorders. The trigger button illuminates while recording. The trigger plugs into the RMT port on the left side of the Odyssey and comes in a six foot standard cable length.

Contact your dealer about ordering part number CD-OD-REMOTE. Custom cable lengths and breakout cables for triggering multiple Odysseys are available for special order.

You may also have a custom cable made if you need a special length or would like to trigger multiple units with one remote. Please see the wiring diagram and other information below.

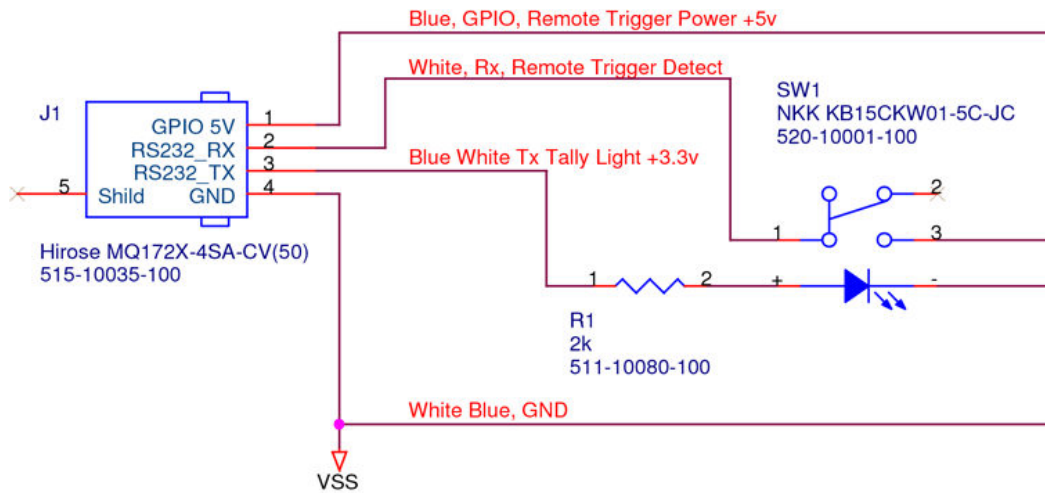

J1 Pin Positions
Plug Backside

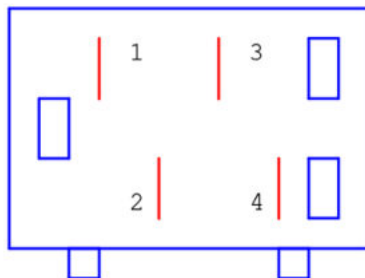

Hirose MQ172X-4SA-CV(50)
515-10035-100

SW1 Pin Positions
Button Backside

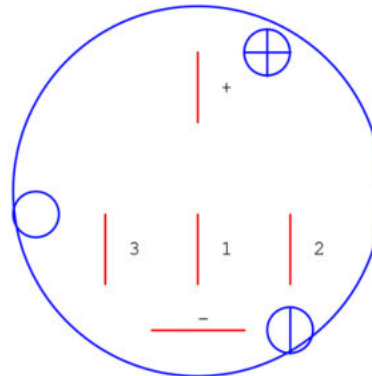

NKK KB15CKW01-5C-JC

Odyssey Activation

Convergent Design requires each Odyssey to be registered via our website. This is so that we can provide notices of free firmware updates, issue alerts for critical issues, and track rentals or purchases of record options.

Upon first initializing of the Odyssey (*see INITIALIZING below*), a prompt will appear asking if the device is to be Activated at this time or if it is to be used in DEMO mode. In DEMO mode the Odyssey is fully functional, however a blue or pink bar “watermark” will appear in any recorded video.

In order to Activate the Odyssey after initial purchase, go to Convergent-Design.com to create a free account and add/activate the device on your account. When you have logged into your new account (or logged into your existing account) you will be able to Add a Device to your account and you will be provided the Basic Activation Key for your device.

The Activation prompt will appear upon every initialization of the Odyssey until the device is Activated. When Activate is selected, follow the prompts to Activate the Odyssey using the Basic Activation Key you were given on the website.

QUICK LINKS

REGISTRATION: [Create a free account on Convergent-Design.com](http://Convergent-Design.com)

ACTIVATION: [Add a Device to your account and receive the Basic Activation Key](#)

ACCOUNT INFO: [Visit your Dashboard to view your device and account information](#)

Also, make sure your Odyssey has the latest firmware, posted here:

FIRMWARE: Convergent-Design.com/firmware

See Firmware Updates under the Appendix below for more information on how to install new firmware on your Odyssey.

Initializing

Plug in power to the Odyssey. It should take about 5-10 seconds to initialize, depending on the mode it is set to. If the Odyssey does not self-initialize, push the **PWR ON** button next to the power socket on the lower left corner of the Odyssey.

As part of the initializing process, SMPTE color bars may appear briefly on the screen. If there is a signal input into SDI A IN that matches the record format the Odyssey is set to, then the image should appear on the screen. If there are SSDs mounted in the Odyssey then a DETECTING SSD message will appear on the lower left of the screen. If the SSD needs to be re-initialized or formatted, a second message may appear. If the Trigger Button in the Upper Tool Bar appears as a red box surrounding a white circle, then the Odyssey is ready to record.

Powering Down



While it may seem an odd time to note this, it is important to know that there is a preferred method to shutting down the Odyssey. On the left side of the case, the F2 SHUT DOWN button should be pressed. This prompts a confirmation to “SAFELY POWER DOWN UNIT?”

Powering down in this fashion properly closes the files and directory system on the SSDs, preventing corruption. If the Odyssey should ever suffer a failure and the F2 SHUT DOWN sequence does not function properly, the unit can be Force Power Off by holding the PWR ON button by the power socket on the lower left corner of the Odyssey, or simply by pulling the power connector out of the power socket. If the Odyssey is ever powered down in this fashion, it is important to run a recovery on the SSDs in the Odyssey menu at MENU » ODYSSEY » SSDs » RECOVER SSD1 » RECOVER SSD2.

Setting Up & Using the Odyssey

The touch screen of the Odyssey features all of the device’s controls in a straightforward, easy to navigate structure. Each box is a “virtual button.” Tap it briefly to activate/deactivate it, or hold it for a few seconds to open up the menu defining its function. The controls at the top of the display (Upper Tool Bar) are the recording, playback and formatting administration. The controls at the bottom of the display (Lower Tool Bar) are the image analysis adjustments.

The Odyssey Menu

Starting on the left, tapping the  button brings up the initial setup menus for the Odyssey. Don’t be intimidated by the number of selections in the  section. This is by far the most in-depth section of the Odyssey touchscreen menus. More information about the Odyssey Menu System is available on the following pages.

Demo Mode (Watermarked)

Out of the box the Odyssey is in DEMO MODE and must be owner-registered with Convergent Design. On the Odyssey a watermarking blue bar will appear on the lower third of the image both on the OLED and in the recording while in DEMO MODE. The Record Options are also available in their own DEMO MODE even once the unit is activated, so that they may be tested but will show a blue bar in the frame. Activation of each Record Option eliminates the blue bar.

To activate the Odyssey after initial purchase, go to Convergent-Design.com, [create a free user account](#) and [add the device to your account](#). When you add a device to your account you will be provided with the Basic Activation Key for that device. Once this is completed, any time you wish to purchase or rent a Record Option, return to the Convergent Design website and purchase or rent the option through our online store. Upon payment the website will present an activation key which can then be entered into the Odyssey by tapping the appropriate selection under the Activation menu. To see if a selection has been enabled, tap on the option’s button to see if ACTIVE appears.

Odyssey ⚙️ Menu

The ODYSSEY Menu allows you to access basic device settings. This is where you can view and enter activation keys, set date, time & metadata, format & recover SSDs and view information about the device such as the firmware version and serial number. It is accessed by tapping **ri** then tapping **ODYSSEY**.

ODYSSEY →		Option	Description	Notes	
SET	ACTIVATION	UNIT	Enter Key or 'OK'	For activating Odyssey (required)	Tap to reveal a key code prompt.
		APOLLO OPTION		Record up to four HD or two 4K signals simultaneously (Multi-stream monitoring is active with UNIT activation.)	To activate the Odyssey after initial purchase, go to Convergent-Design.com, create an account and add the device. Once this is completed, anytime one wishes to purchase or rent a recording option, return to the Convergent Design website and follow the prompts. The website will present a code which can then be entered into the Odyssey on the [activation] menu page. To see if a selection has already been enabled, tap on that option's button to see if ACTIVE appears.
		RAW BUNDLE		Record RAW and high quality video derived from the RAW signal from certain cameras. [More Info]	
<p>DEMO MODE: ALL AVAILABLE RECORD OPTIONS ARE FUNCTIONAL IN A DEMO MODE, BUT IF THE OPTION HAS NOT BEEN ACTIVATED THE IMAGE FOR THAT OPTION WILL APPEAR WITH A LARGE BLUE BAR "WATERMARK" ON SCREEN WHEN RECORDING. THIS BAR IS RECORDED IN THE IMAGE FILE.</p>					
SSDS		ERASE & FORMAT SSD1	Permanently erases everything on SSD1.	FORMATTING IS A DESTRUCTIVE PROCESS AND WILL ERASE ANY FILES CURRENTLY ON THE SSD. BE SURE TO DOWNLOAD ALL FILES BEFORE FORMATting.	
		ERASE & FORMAT SSD2	Permanently erases everything on SSD2.		
		ERASE & FORMAT BOTH	Permanently erases everything on both cards.		
		REBUILD SSD1	Non-destructively recovers /rebuilds file system of SSD1	Use only in extreme cases (such as if a computer corrupts the SSDs file system).	
		REBUILD SSD2	Non-destructively recovers /rebuilds file system of SSD2		
 <p>PLEASE NOTE: Formatting should be performed at the start of use of any new SSDs and the start of any new project. Recovery is for when the SSD was not properly dismounted from the Odyssey. This includes physically removing the SSD without running the eject sequence, sudden loss of power to the Odyssey or improper powering down of the Odyssey. The Recover process accesses any incomplete files on the SSD and, when possible, properly closes them. NOTE: FORMATTING OF SSDs SHOULD ALWAYS BE PERFORMED ON THE ODYSSEY.</p>					
	TIME	Set the appropriate time.		IMPORTANT FOR RECORDING OPTION RENTALS	
	DATE	Set the appropriate date.			
RESET		MENU	Restore all default settings.	Does not effect firmware version or record options.	
		METADATA	Resets metadata fields		
		ALL (FACTORY DEFAULTS)	Resets all settings		
		RESET (DELETE) LUTS	Deletes User LUTs		
	ABOUT	Displays the firmware version, serial number, warranty status, and which Options are activated. Check our website regularly to ensure you are running the current firmware.			

The remainder of the **ri** menu replicates controls available on the Upper Tool Bar when the Odyssey is in RECORD mode.



SETUP

Controls for Camera Type, Recording Format, and Trigger. Replication of **RECORD STATUS** button controls (for details see page 21)

INPUTS

Controls for video and timecode inputs. Replication of **INPUT/OUTPUT STATUS** button (Input Control Settings) (for details see page 19)

OUTPUTS

Controls for video outputs. Replication of **INPUT/OUTPUT STATUS** button (Output Control Settings) (for details see page 20)

AUDIO

Controls for Audio settings. Replication of **AUDIO STATUS** button (for details see page 23)

Congratulations! You are through the ⚙️ menu. Everything gets easier from here. Please note that many of these controls are also available in the rest of the Upper Toolbar.

Upper Tool Bar (Record Mode)

Tapping the REC/PLAY Button toggles the Upper Tool Bar between Play mode and Record mode. Upper Toolbar selections are different in Play Mode than in Record Mode. Some buttons appear in all modes while others will only appear in a certain mode.

Upper Tool Bar Controls (Record Mode)



- | | |
|---------------------------------------|-------------------|
| 1 ⚙️ MENU BUTTON | 7 SSD SAFE EJECT |
| 2 SYSTEM STATUS | 8 SSD2 STATUS |
| 3 INPUT/OUTPUT STATUS (REC MODE ONLY) | 9 REC/PLAY TOGGLE |
| 4 RECORD STATUS (REC MODE ONLY) | 10 CLIP METADATA |
| 5 TRIGGER BUTTON (REC MODE ONLY) | 11 LAST TAKE |
| 6 SSD1 STATUS | 12 AUDIO |

System Status (All Modes)

12.2V
8.1W
+40°C

```

SYSTEM STATUS
VOLTS: 12.1V (6.5-34V)
POWER: 10.0W
TEMP: +31° (<60°C)
2014 AUG 21 08:42:58
ODYSSEY7Q ABOUT
FIRMWARE: 2.20.10 OCT 2014
SERIAL: 20-00000
WARRANTY: VOID
KEYS ACTIVATED:
BASIC FS700RAW CANONRAW
POWERED: 41 DAYS 19 HRS
RECORD: 9 DAYS 4 HRS
    
```

Displays critical specs of Odyssey7Q+. Input voltage, Current wattage draw of Odyssey (varies with mode), current temperature of main processor. Tapping button brings up more detailed information including the ABOUT menu of the Odyssey7Q+.

The Odyssey has a wide internal operating temperature window, up to 65° Celsius (149° Fahrenheit). The Odyssey uses its magnesium case to passively shed excess heat.

There are no vents or fans in the Odyssey7Q+. Even under most harsh conditions, the Odyssey should not suffer any operational issues due to heat. However, if the internal temperature of the Odyssey rises high enough there are a series of warnings and safeguards in place to protect the device and the recorded files.

TEMPERATURE WARNINGS AND SAFEGUARD

	System Status Text & Warning	Operational Protection
59° C	Yellow text	No change to operation
61° C	Red text & flashing warning	New recordings prevented
65° C	Red text & flashing warning	Current recording stopped

The Odyssey has a wide range of acceptable voltage for incoming power, from 6.5 volts to 34 volts. The total wattage draw from the Odyssey varies depending on the operational mode it is set to, but is always within a very modest range from less than 8 watts to no more than 15 watts. This allows a variety of battery options to be used with the device. While there are file recovery parameters in place, it is never a good idea to lose power while in the midst of recording. If the incoming voltage to the Odyssey drops low enough there are a series of warnings and safeguards in place to protect the device and the recorded files.

LOW POWER WARNINGS & SAFEGUARDS

	System Status Text & Warning	Operational Protection
6.7v	Yellow text	No change to operation
6.5v	Red text & flashing warning	New recordings prevented
6.0v	Red text & flashing warning	Current recording stopped

Input/OUTPUT Status (Record Mode ONLY)

29.97 4K
S-LOG2

Displays current video input signal type. Tapping button brings up detailed information on Input and Output signals, record mode and frame rates.

Input Control Settings

VIDEO CADENCE :

This identifies the cycling of the signal coming into the Odyssey and how it is to be recorded.

Available Cadences:

PROGRESSIVE/PSF: For video signals structured as True Progressive (p) or Progressive Segmented Frames (PSF).

INTERLACED: For HD video signals structured as interlaced fields (i). Records a 1080i50 or 1080i60 video signal without alteration. Note that some cameras carry progressive video embedded within an interlaced signal. See 3:2 Pulldown below.

REMOVE 3:2 PULLDOWN (TO 24P): For 24p video signals striped within a 60i signal. Extracts the 24p video, records it as 1080p24 and discards the excess fields for greater efficiency and smoother post.

TIMECODE SOURCE :

Allows selection for origination of timecode. Note that some video sources do not carry timecode data and at high frame rates some cameras do not generate timecode. In these cases the Odyssey will generate a Record Run timecode from its internal clock. LTC not supported when recording ARRIRAW.

Available Timecode Sources

SDI/HDMI (embedded in incoming signal)

LTC (input from external source to LTC port)

TIME-OF-DAY NDF (Odyssey internal clock, non-drop frame counting)

TIME-OF-DAY DF (Odyssey internal clock, drop frame counting)

SEED/RECORD RUN (Set timecode counter, increments while recording)

TEST PATTERN :

Displays reference image on OLED and video outputs. Choose between SMPTE, EBU 75% and EBU 100% color bars.

4K/2K VIEWING :

Determines monitoring of 17:9 video signals on OLED and video outputs.

Available Viewing Options

LETTERBOX 17:9: Shows full frame with black borders above and below image. NOTE: Reduction of image may cause aliasing in monitored image.

CENTER CUT 16:9: Shows center 16:9 portion of 17:9 frame.

ANAMORPHIC DESQ:

Horizontally stretches image to correct for use of optical anamorphic lenses. Image altered on OLED screen as well as SDI and HDMI outputs. Does not affect recording. Options are labeled in squeeze multiplier and displayed aspect ratio. Full Frame options always show full width and height of recorded signal. Center Extraction options show popular extracted frames.

OFF: image unaltered

FULL FRAME:

1.33x (2.37:1): 1.33x horizontal stretch, 2.37:1 aspect ratio

1.5x (2.67:1): 1.5x horizontal stretch, 2.67:1 aspect ratio

2.0x (3.56:1): 2.0x horizontal stretch, 3.56:1 aspect ratio

CENTER EXTRACTION:

1.33X (1.78:1): Stretches center 4:3 image to cover 16:9 frame

2.0x (2.39:1): 2.0x stretch with image zoom & borders to crop to 2.39:1

2.0x (2.67:1): 2.0x stretch with image zoom to crop to 2.67:1

LEGALIZE HDMI:

Adjusts for incoming video signals that may extend beyond the broadcast-legal range of 0-100 IRE.

Output Control Settings

The settings of the OUTPUTS menu allow adjustments to the video outputs of the Odyssey7Q+. The OUTPUTS menu is accessed by tapping * then tapping OUTPUTS.

VIDEO PSF OUT:

On/Off control to switch video outputs from True Progressive (p) to Progressive Segmented Frames (psf) signal structure. This improves compatibility with some third-party equipment.

RECORD TALLY:

On/Off control to activate Tally record status indicator over SDI and HDMI outputs. Tally appears as colored bar at bottom of image. Green Tally indicates ready to record and Red Tally indicates recording in progress.

CUSTOMIZE SDI A:

Allows for signal overlay onto SDI A OUT video.

LUT OFF sends out the video signal or representation of the RAW data signal with no alteration.

LUT ON applies the LUT image adjustment as selected in the LUT menu.

MIRROR OLED applies whatever overlays are present on the OLED panel, including LUT and monitoring tools activated such as Waveform.

CUSTOMIZE SDI B:

Allows for signal overlay onto SDI B OUT video.

LUT OFF sends out the video signal or representation of the RAW data signal with no alteration.

LUT ON applies the LUT image adjustment as selected in the LUT menu.

MIRROR OLED applies whatever overlays are present on the OLED panel, including LUT and monitoring tools activated such as Waveform.

CUSTOMIZE HDMI :

Allows for signal overlay onto HDMI OUT video.

LUT OFF sends out the video signal or representation of the RAW data signal with no alteration.

LUT ON applies the LUT image adjustment as selected in the LUT menu.

MIRROR OLED applies whatever overlays are present on the OLED panel, including LUT and monitoring tools activated such as Waveform.

RECORD STREAMS

DUAL-HD MONITORING / RECORDING

Available in HD 4:2:2-> HD ProRes mode only.. Odyssey Dual-HD Monitoring function allows viewing of two HD video streams while recording one. Available inputs are SDI A, SDI B and HDMI. Connecting to HDMI input overrides the SDI A input, making available combinations SDI A + SDI B or HDMI + SDI B. Select which input to record, either SDI A / HDMI or SDI B.

Dual-HD signals are automatically detected upon input. Both signals must match in resolution (1080 or 720), frame rate (24, 25, 30, 50 or 60) and cadence (progressive or interlace). SDI B input is only available if a signal is present in SDI A or HDMI inputs. Dual-HD Monitoring adjustments are in the OLED menu.

Included in the purchase of the Odyssey RAW Bundle is the option of Dual-HD Recording. Dual-HD Recording allows both HD video signals to be recorded simultaneously. Two SSDs are required, as SDI A/HDMI will record to SSD A and SDI B will record to SSD B. Both signals must match in resolution, frame rate and cadence. In 1080p the top available frame rate is 30p. Matching timecode on each recording can be generated from the Master camera, from within the Odyssey, or input using the LTC IO port.

TIMECODE OUT

On/Off control to activate an onscreen timecode window display over SDI and HDMI outputs.

Record Status (Record Mode ONLY)

4K ->4K
PRORES

Displays current recording format. Tapping button brings up detailed information on recording format and frame rates as well as controls for setting monitoring and recording modes. *If a rented Record Option is in use, the remaining time is noted here.*

Mode/Record Options

CAMERA:

Tapping status boxes brings up a list of selections for each. Choice of **CAMERA** determines **MONITOR -> RECORD** selections for that camera. CAMERA also determines Trigger, Timecode and LUT integration.

Available cameras:

Sony FS7/FS700
Sony (F3, F5 and F55 and others)
Canon (C500 and others)
ARRI (ARRI Alexa)
POV RAW (IndieCam and IO Industries)
Other (sundry HD video sources)
Panasonic
RED
Multi-Stream (Quad-Stream Monitoring or Apollo)

For more information see the Apollo Option section of this manual.

MONITOR ->RECORD

Displays options for the currently selected camera
(See the [MONITOR-->RECORD OPTIONS chart in APPENDIX \(p59\)](#) (for full list of options in this menu selection)

RECORD STREAM

Available in HD 4:2:2-> HD ProRes mode only. Odyssey Dual-Stream Monitoring function allows viewing of two HD video streams while recording one. Available inputs are SDI A, SDI B and HDMI. Connecting to HDMI input overrides the SDI A input, making available combinations SDI A + SDI B or HDMI + SDI B. Select which input to record, either SDI A / HDMI or SDI B.

DUAL-STREAM MONITORING

Dual-Stream signals are automatically detected upon input. Both signals must match in resolution (1080 or 720), frame rate (24, 25, 30, 50 or 60) and cadence (progressive or interlace). SDI B input is only available if a signal is present in SDI A or HDMI inputs. Dual-Stream Monitoring adjustments are in the OLED menu.

A future firmware update will offer option of DUAL-Stream Recording, allowing both video signals to be recorded simultaneously. This option will be included in the Odyssey RAW Bundle.

VIDEO CODEC

Displays current recording format. In compressed recording, tap status box for list of options. In Apple ProRes 422, available compression levels are HQ, 422, and LT. To record 2K/HD Apple ProRes in 4444(XQ) or 4444, select in the [MONITOR->RECORD] menu.

RECORD TRIGGER:

Allows selection of record trigger mechanism for Odyssey7Q. Note that some cameras do not output trigger signals over SDI or HDMI.

AVAILABLE RECORD TRIGGERS

RECORD BUTTON (Tap Record Button on Upper Toolbar to start/stop recording)

CAMERA (Use camera's trigger to stop/start recording -- trigger output must be enabled on camera)

TIMECODE (Use detection of timecode incrementing to start/stop recording -- Odyssey TIMECODE must be set to SDI/HDMI or LTC and timecode source set to Record Run)

REMOTE (Use the Convergent Design Remote Trigger accessory to start/stop recording.)

PROJECT RATE:

Determines playback frame rate from the SSDs. Note that all incoming frames are always recorded, Project Rate only determines the intended playback speed, which can always be changed in post. The Project Rate can follow the incoming source frame rate or be set to a specific rate for faster or slower than real time playback.

FOLLOWS INPUT is the default setting, automatically aligning to the incoming framerate at speeds 60p and below. At higher incoming frame rates, 100/200p signals have a default Project Rate of 25p and 120p/240p signals default to 24p. This allows an even division of frames for smooth playback.

Available Project Rates

FOLLOWS INPUT (default setting)

23.98 FPS

24.00 FPS

25.00 FPS

29.97 FPS

30.00 FPS

48.00 FPS

50.00 FPS

59.94 FPS

60.00 FPS

TRIGGER button (Record Mode ONLY)



Displays status of recording mode. When button is Red with a white circle it is ready to record. When Gray there is no signal available to record. While recording, the button is Blue with a white square and the background of the entire top menu is Red. If REC Button is selected as the trigger then tapping button triggers record start/stop

⚙️ » **SETUP** » **RECORD TRIGGER:** » **RECORD BUTTON**

or tap on Record Status » **RECORD TRIGGER:** » **RECORD BUTTON**

SSD1 Status (All Modes)



Displays record time available given current settings (HH:MM). Tapping button brings up detailed information on SSD1 status. Formatting and rebuilding options are also available here.

Safe Eject (All Modes)



Prompts a confirmation to Safely Eject one or both of the SSDs. This is the proper method for dismounting and ejecting SSDs so that the files and directories can be closed properly.

SSD2 Status (All Modes)



Displays record time available given current settings (HH:MM). Tapping button brings up detailed information on SSD2 status. Formatting and rebuilding options are also available here.

Rec/Play (All Modes)



Displays current status as to whether Odyssey is in RECORD or PLAY mode. Tapping button toggles between modes. NOTE: Playback Mode changes the upper and lower tool bars. See Play Mode, below.

Clip metadata (All Modes)

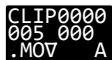

Displays current recording format. Tapping button brings up detailed information on recording type and frame rates. *If a rented Record Option is in use, the remaining time is noted here.*

Last Take button (Record Mode ONLY)



Displays timecode start and elapsed time of last recorded take. Tapping button brings up detailed information of the last take recorded.

Audio Status (All Modes)



Displays audio levels. Tap button for Audio Display/Control settings.

Audio Meters settings

SHOW (display audio levels as BARS or numerical VALUES)

BAR COLORS (set yellow level to -20 or -18 dB)

METERS (turn ON or OFF audio levels display)

AUDIO Options

AUDIO CHANNELS:

In Apple ProRes recording, this is locked to eight channels, including Dual-HD and Apollo Quad-HD. In Apollo Dual-4K recording this is locked to 4 channels per input. In all other modes this is locked to two channels.

AUDIO SOURCE:

Allows selection of audio input source.
SDI/HDMI (embedded in incoming signal)
ANALOG (analog 2-channel input via AUD IN port)

HEADPHONE OUT (dB):

Volume adjustment of AUD OUT port.

ANALOG MIX IN:

For analog audio input via AUD IN port, select between STEREO UNBALANCED (two discreet channels) or MONO BALANCED (one source to record over both channels).

ANLG GAIN IN (dB):

Adjust analog audio input levels for AUD IN port.

Lower Tool Bar (Record Mode)

In addition to being a high quality recorder of multiple formats, the Odyssey is also a full-featured production monitor. The Lower Tool Bar activates and controls the monitoring tools and image analysis functions.

OLED GUIDE LUT FOCUS ZOOM 00:12:16:72 FALSE ZEBRA WFM HIST HIDE

OLED

OLED

Tapping button brings up OLED monitor settings. Controls are for the Odyssey OLED panel only and will not affect the recorded signal or the signal from any of the device's outputs. The Odyssey7Q+ display is capable of presenting the full contrast and color gamut of both the REC709 and DCI-P3 standards.

Assuming a standard, properly attenuated video signal from the camera source, the display defaults are 100% for SATURATION, CONTRAST, BRIGHTNESS, Red/Green/Blue GAINS and R/G/B BIASES. Adjustable ranges are 50%-140%. BASE standard is Medium and COLOR GAMUT is REC.709. Unless otherwise noted, any standard video source accepted by the Odyssey7Q+ should be a REC709-compliant signal, not DCI-P3, which is for digital cinema displays.

ORIENTATION controls the vertical orientation of the image on the OLED display.

TEST PATTERN replaces the video signal with SMPTE or EBU color bars. This is the only control that also affects the video outputs.

MORE TOOLS Alternates buttons on the Lower Tool Bar between different monitoring functions. Alternate OLED & GUIDE with DUAL-STREAM, FALSE COLOR with MONOCHROME, ZEBRAS with SPOT METER, and HISTOGRAM with VECTORSCOPE. Exchange controls operate independently and are available in each effected tool's menu.

Guide

GUIDE

Tapping button activates Frame Guides. Holding button brings up the Frame Guides settings. Presets available are 1.33:1, 1.85:1 and 2.39:1. Press CREATE CUSTOM GUIDE to bring up the Custom Guide menu. Name and save up to four custom frame guides. Left/Right control sets frame sides. Top/Bottom control sets frame lids. Linking adjusts Left/Right or Top/Bottom together. Rectangle eliminates lines outside inner box. Select colors between White | Black | Red | Green | Blue | Yellow. Up to four custom frame guides plus one preset frame guide can be displayed at the same time.

Dual-HD Monitoring/Recording [DUAL]

DUAL

Available in HD 4:2:2-> HD ProRes mode only. Odyssey Dual-HD Monitoring function allows viewing of two HD video streams while recording one. Available inputs are SDI A, SDI B and HDMI. Connecting to HDMI input overrides the SDI A input, making available combinations SDI A + SDI B or HDMI + SDI B. Select which input to record, either SDI A / HDMI or SDI B.

Dual-HD signals are automatically detected upon input. Both signals must match in resolution (1080 or 720), frame rate (24, 25, 30, 50 or 60) and cadence (progressive or interlace). SDI B input is only available if a signal is present in SDI A or HDMI inputs.

Included in the purchase of the Odyssey RAW Bundle is the option of Dual-HD Recording. Dual-HD Recording allows both HD video signals to be recorded simultaneously. Two SSDs are required, as SDI A/HDMI will record to SSD A and SDI B will record to SSD B. Both signals must match in resolution, frame rate and cadence. In 1080p the top available frame rate is 30p. Matching timecode on each recording can be generated from the Master camera, from within the Odyssey, or input using the LTC IO port

Dual-HD Monitoring/Recording Adjustments

The two video signals can be viewed simultaneously in Side-by-Side, Top-Bottom, or Picture-in-Picture configurations. The Picture-in-Picture mode allows selection of the smaller image to be positioned on the lower left or lower right of the OLED screen. Tapping the smaller image will alternate the two video signals between the larger and smaller view. Each individual video signal can also be viewed without the other visible. The OLED and GUIDE buttons are replaced with DUAL, A, and B buttons. Tapping A or B shows only that video signal. Tapping DUAL shows the selected dual-display mode. Holding the DUAL button brings up the Dual-HD settings.

In Dual-HD mode, the SDI video outputs can be set to two different modes. In Mirror OLED mode, the SDI outputs display the same signal path of the OLED screen, showing the selected dual-display mode or individual video signals depending on the selection of the DUAL, A or B buttons. In A->A, B->B mode the SDI A / HDMI input is output directly to SDI A OUT and the SDI B input is output directly to SDI B. In this mode it is not possible to view Monitoring Tools, LUT or Timecode Window over SDI, and only true Progressive or Interlace signals will be output (PSF will be shown as Progressive). The HDMI output always remains in Mirror OLED.

LUT

LUT

Tapping button activates the chosen LUT on the OLED display. Holding button brings up the LUT menu.

A Look Up Table (LUT) is a set of exposure, contrast and color offsets to adjust an image. Originally designed as a tool to indicate on one display how an image would appear on a different type of display, LUTs have expanded to also become tools to preview color grading decisions. The Odyssey7Q+ includes numerous 3D-LUTs for previewing the LOG video outputs of several popular cameras in standard REC709 contrast and color. The RAW record options also feature monitoring LUTs.

SELECTING LUTS

Holding LUT button brings up the LUT menu. LUTS can be selected from an SSD, the PRESET LUTS folder, or one of three custom LUT folders (for details see below). A list of available LUTs from each source will appear in the menu and a LUT can be selected by tapping on it. Additional LUTs can also be downloaded from the Convergent Design website.

ROUTING LUTS

Once a LUT is selected, it can be output to various locations. Tapping LUT button activates the LUT on the OLED display. In the LUT menu, CUSTOMIZE OUTPUTS brings up the LUT routing controls. SDI A OUT, SDI B OUT and HDMI OUT can be individually addressed for LUT output, as can the MONITORING TOOLS.

LUT OFF sends out the video signal or representation of the RAW data signal with no alteration. **LUT ON** applies the LUT image adjustment as selected in the LUT menu.

MIRROR OLED applies whatever overlays are present on the OLED panel, including LUT and monitoring tools activated such as Waveform.

This means that the Monitoring Tools (False Color, Monochrome, Zebras, Waveform, Histogram, Vectorscope) can always read the original input signal (LUT OFF), always read the LUTted image (LUT ON), or switch between them depending on what is displayed on the OLED (MIRROR OLED). A green bar connects the buttons for the monitoring tools to indicate when they are reading the LUTted image.

Likewise, the individual video outputs can always display the original image (LUT OFF), always display a LUTted image (LUT ON), or mimic whatever is displayed on the OLED, including the overlay of the monitoring tool on the image (MIRROR OLED).

In a future free firmware update, it will also be possible to choose to record video files to the SSD with a LUT applied.

CUSTOM LUTS

The Odyssey7Q+ also supports custom 3D-LUTs imported into the device. Standard .cube (aka Image Cube) files are supported in 17x17x17, 33x33x33 and 65x65x65 bit depths. These can commonly be generated in programs such as Resolve or Pomfort LiveGrade.

LOADING CUSTOM LUTS

LUTs must be saved on a computer and then imported into the CD LUT Utility (available for download on the Convergent Design website) for translation into the Odyssey LUT format. Load LUTs onto an Odyssey SSD or Utility Drive and mount in the Odyssey7Q+. Select IMPORT FROM SSD in the LUT menu to read SSD for LUTs. LUTs can be PREVIEWED by tapping on individual file name, but a destination folder must be selected in order to load LUTs onto the Odyssey7Q+. There are three folders for imported LUTs and up to 150 LUTs can be stored within them.

LUT RANGE

The video signal from 0 to 100% can be represented by the "Legal Range" from 64 to 940, or by the "Extended Range" from 0 to 1023. A Legal Range representation can carry values outside the 0-100% range. An Extended Range representation cannot. LUTs are designed to expect either a Legal or Extended Range input and produce a Legal or Extended Range output. The designations LL (Legal in, Legal out) or EE (Extended In, Extended Out) are sometimes used in LUT names to indicate this. The Odyssey preset LUTs are all EE. Custom LUTs may not be. The LUT RANGE control allows selection of the range type of LUT being used.

METADATA

Tapping the METADATA button opens the LUT FILE METADATA menu. For each LUT, a Project or camera can be marked, and a notes field is also available.

MANAGE LUTS

Tapping the MANAGE LUTS button opens the LUT Management menu. Custom LUTs can be deleted from the folders and folders can be renamed.

Focus

FOCUS

Tapping button activates Focus Assist. Holding button brings up the Focus Assist settings. There are three styles of Focus Assist available.

PEAKING

Edge detection based on contrast, with variable sensitivity. Image can be displayed with edges highlighted in red, green, blue, black white or yellow. Or only detected edges can be displayed as white, with other image elements in black.

REVEAL

This is a more complex focus detection system based on differences within the image. Can be displayed as edges only or combined with Peaking under the Peaking menu

NOISE REDUCTION (ON/OFF)

Image noise filter improves legibility of Focus Assist. This tool is for monitoring only and does not affect the recorded image.

Pixel Zoom

ZOOM

Pixel Zoom enlarges a section of the image on the OLED panel to better judge focus and other aspects of the image. The resolution of the video area of the OLED panel is 1280x720. 1:1 zoom and 2:1 zoom enlarge a select section of the image to a pixel-for-pixel crop. 1:1 shows a 1280x720 crop from a 2K/HD signal, 2:1 shows a 1280x720 crop from a 4K/UHD signal.

Hyper Zoom modes show a reference window on the image and an enlarged representation of the image within that window on the lower right corner of the OLED screen. Hyper Zoom modes include 4:1, 6:1, 8:1, 10:1 and 12:1. When the Odyssey7Q+ is set to a 4K->HD SuperSampling mode, the Pixel Zoom functions reference the original higher resolution image.

To adjust the area of the image referenced in any Pixel Zoom mode, drag a finger or stylus on the OLED screen. The movement can be selected to drag the image within the window or to move the window over the image. In 1:1 and 2:1, tap Zoom Window box to re-center image. In Hyper Zoom modes, select from six colors for the outline of the reference window.

Timecode

00:12:16:04

At the center of the Lower Tool Bar is a counter displaying timecode.

This counter displays hours, minutes, seconds and frames in the format 00:00:00:00.

A Timecode Window display can be overlaid on the SDI and HDMI outputs. This is selectable in the OUTPUT menu on the Upper Tool Bar.

False Color

FALSE

Tapping button activates False Color. Holding button brings up False Color settings. False Color is an exposure reference tool, attributing different colors to various brightness portions of the image. Available colors are Red, Yellow, Pink, Green, Blue and Purple. A video signal is measured in a scale from -7 to 109, often marked as a % or with the suffix IRE.

Brightness range for each color can be individually selected with a high and low setting or that color can be switched off. Ranges can overlap, and any exposure value not selected will be indicated in a monochrome brightness. There is a reference bar at the bottom of the image indicating the exposure range each color represents.

TOOLS: LUT OPTIONS

The False Color tool can be set to measure the source video signal or the video with a LUT applied to it. This is a replication of a control in the LUT menu and adjusting it affects all Monitoring Tools. The Monitoring Tools (False Color, Monochrome, Zebras, Spot Meter, Waveform, Histogram, Vectorscope) can always read the original input signal (LUT OFF), always read the LUTted image (LUT ON), or switch between them depending on what is displayed on the OLED (MIRROR OLED). A green bar connects the buttons for the monitoring tools to indicate when they are reading the LUTted image.

MORE TOOLS

This setting alternates the button on the Lower Tool Bar to the right of the timecode display between the FALSE COLOR tool and the MONOCHROME DISPLAY tool.

Monochrome

MONO

Tapping button activates Monochrome. Holding button brings up the Monochrome settings. Monochrome represents the individual color channels (Red/Green/Blue) or the overall brightness (Luma) in a gray scale image.

TOOLS: LUT OPTIONS

The Monochrome tool can be set to measure the source video signal or the video with a LUT applied to it. This is a replication of a control in the LUT menu and adjusting it affects all Monitoring Tools. The Monitoring Tools (False Color, Monochrome, Zebras, Spot Meter, Waveform, Histogram, Vectorscope) can always read the original input signal (LUT OFF), always read the LUTted image (LUT ON), or switch between them depending on what is displayed on the OLED (MIRROR OLED). A green bar connects the buttons for the monitoring tools to indicate when they are reading the LUTted image.

MORE TOOLS

This setting alternates the button on the Lower Tool Bar to the right of the timecode display between the FALSE COLOR tool and the MONOCHROME DISPLAY tool.

Zebra

ZEBRA

Tapping button activates Zebras. Holding button opens Zebras settings. A Zebra stripe (////) is an exposure tool to indicate any part of the image that is at a particular brightness. There are two Zebra stripe patterns, //// and \\\\. Each Zebra pattern can be represented in Black, White, Red, Green, Blue, Yellow, Cyan, or Magenta colored stripes, and the underlying image is visible in between the stripe lines. Brightness range for each Zebra pattern can be individually selected with a high and low setting or that Zebra pattern can be switched off. Ranges can overlap, and any exposure value not selected will be represented as it appears in the underlying image.. There is a reference bar at the bottom of the image indicating the exposure range each Zebra pattern represents.

TOOLS: LUT OPTIONS

The Zebras tool can be set to measure the source video signal or the video with a LUT applied to it. This is a replication of a control in the LUT menu and adjusting it affects all Monitoring Tools. The Monitoring Tools (False Color, Monochrome, Zebras, Spot Meter, Waveform, Histogram, Vectorscope) can always read the original input signal (LUT OFF), always read the LUTted image (LUT ON), or switch between them depending on what is displayed on the OLED (MIRROR OLED). A green bar connects the buttons for the monitoring tools to indicate when they are reading the LUTted image.

MORE TOOLS

This setting alternates the button on the Lower Tool Bar one button to the right of the timecode display between the ZEBRA tool and the SPOT METER tool.

Spot Meter

SPOT

Tapping button activates Spot Meter. Holding button brings up the Spot Meter settings. Spot Meter is an exposure reference tool, presenting a brightness reading at a selected part of the image in both brightness (Luma) as well as the three separate color channels (Red, Green, and Blue).

The Spot Meter can be set to display a single-measurement target, two-measurement targets or eight-measurement targets. To adjust the position of the targets, drag a finger or stylus on the OLED screen. The spot size is adjustable in pixels to 1x1, 8x8 or 16x16. The brightness values can be set to read in an 8-bit structure, a 10-bit structure or in IRE values. When in the two-measurement targets mode, a chart display shows the comparative values from each target. A graphic comparison display can be set to show the two target values side-by-side or the differential between them. The chart appears in the upper left or right corner of the OLED screen. Its position can be alternated by tapping on the chart.

NOTE: The Spot Meter cannot be enabled while recording.

TOOLS: LUT OPTIONS

The Spot Meter tool can be set to measure the source video signal or the video with a LUT applied to it. This is a replication of a control in the LUT menu and adjusting it affects all Monitoring Tools. The Monitoring Tools (False Color, Monochrome, Zebras, Spot Meter, Waveform, Histogram, Vectorscope) can always read the original input signal (LUT OFF), always read the LUTted image (LUT ON), or switch between them depending on what is displayed on the OLED (MIRROR OLED). A green bar connects the buttons for the monitoring tools to indicate when they are reading the LUTted image.

MORE TOOLS

This setting alternates the button on the Lower Tool Bar one button to the right of the timecode display between the ZEBRA tool and the SPOT METER tool.

Waveform

WFM



Tapping button activates Waveform. Holding button brings up Waveform settings. A Waveform is an exposure tool used for measuring the brightness of the image throughout the frame. It can be set for overall brightness (Luma), with the three color channels separated (RGB Parade), or as the individual color channels only (Red, Green, or Blue). The Waveform display aligns left-right to the image on the OLED display. In Multi-Stream mode, if two images are displayed side-by-side then the Waveform can be used to compare the signals.

The Waveform can be displayed across the majority of the OLED screen or in the lower right corner. In the large display, the RGB Parade shows three individual waveforms side-by-side in their appropriate colors, while in the small display the three colors overlap. The Waveform background can be switched between translucent and opaque to allow the video image to be visible behind the Waveform display for reference. A graticule overlay indicates exposure value references in 10% increments in the large display and 20% increments in the small display, both with an additional reference for 109%. The full range displayed is from -7% to 109%.

TOOLS: LUT OPTIONS

The Waveform tool can be set to measure the source video signal or the video with a LUT applied to it. This is a replication of a control in the LUT menu and adjusting it affects all Monitoring Tools. The Monitoring Tools (False Color, Monochrome, Zebras Spot Meter, Waveform, Histogram, Vectorscope) can always read the original input signal (LUT OFF), always read the LUTted image (LUT ON), or switch between them depending on what is displayed on the OLED (MIRROR OLED). A green bar connects the buttons for the monitoring tools to indicate when they are reading the LUTted image.

Histogram

HIST

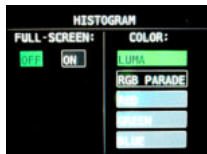

Tapping button activates Histogram. Holding button brings up Histogram settings. A Histogram is an exposure tool indicating brightness by volume of image across a horizontal plane. The brighter the image the farther it is to the right. The more of an image registering at a particular brightness the taller the line graph at that brightness. It can be set for overall brightness (Luma), with the three color channels separated (RGB Parade), or as the individual color channels only (Red, Green, or Blue).

The Histogram can be displayed across the majority of the OLED screen or in the lower right corner. In the large display, the Histogram can display Luma, RGB Parade (as color overlaps), or the individual color channels (Red, Green, or Blue). In the small display Luma and RGB Parade (overlap) can be displayed. On the large display, graticules indicates exposure value references in 10% increments with an additional reference for 109%. The full range displayed is from -7% to 109%.

TOOLS: LUT OPTIONS

The Histogram tool can be set to measure the source video signal or the video with a LUT applied to it. This is a replication of a control in the LUT menu and adjusting it affects all Monitoring Tools. The Monitoring Tools (False Color, Monochrome, Zebras, Waveform, Histogram, Vectorscope) can always read the original input signal (LUT OFF), always read the LUTted image (LUT ON), or switch between them depending on what is displayed on the OLED (MIRROR OLED). A green bar connects the buttons for the monitoring tools to indicate when they are reading the LUTted image.

MORE TOOLS

This setting alternates the button on the Lower Tool Bar to the left of the HIDE button between the HISTOGRAM tool and the VECTORSCOPE tool.

Vectorscope

VEC

Tapping button activates Vectorscope. Holding button brings up Vectorscope settings. A Vectorscope measures the color spectrum represented in the video signal. Different hues are represented by the rotation around the circle. Different saturations are represented by the distance from the center to the perimeter of the circle. Reference targets represent specific values in both hue and saturation. Two diagonal lines bisect the Vectorscope circle. The “I” line passes from orange to blue hues, and roughly represents the tonal reference for common skin tones. The “Q” line passes from green to magenta and is useful in indicating imbalance between those opposing hues.

The Vectorscope can be displayed as a small circle in the lower right corner of the OLED or a large circle filling the center of the OLED. The background can be black or translucent so that the source video is visible. The I/Q lines can be displayed or shut off. The color reference targets can be located at 75% or 100% saturation levels to accommodate different incoming reference signals. The Vectorscope can display in an Analog or Digital format. In Analog, the video image is scanned from left to right and this “trace” is represented as a continuous line connecting the different color references in the signal. In Digital only the color references are displayed. The Vectorscope trace can display in green or in a true color (true CbCr) representation that indicates both the hue and saturation.

The Vectorscope signal representation can be zoomed in order to better see subtle variations and to accurately align to certain reference charts. Adjust the zoom by a finger-drag on the OLED screen. Dragging a finger from left to right zooms from 1.0x to 15.0x in 0.1 increments. Dragging a finger from bottom to top zooms from 1.0 to 15.0 in 1.0 increments. A magnification indicator is displayed in the upper right corner of the image while the Vectorscope is active.

NOTE: The Vectorscope cannot be enabled during recording.

TOOLS: LUT OPTIONS

The Vectorscope tool can be set to measure the source video signal or the video with a LUT applied to it. This is a replication of a control in the LUT menu and adjusting it affects all Monitoring Tools. The Monitoring Tools (False Color, Monochrome, Zebras, Spot Meter, Waveform, Histogram, Vectorscope) can always read the original input signal (LUT OFF), always read the LUTted image (LUT ON), or switch between them depending on what is displayed on the OLED (MIRROR OLED). A green bar connects the buttons for the monitoring tools to indicate when they are reading the LUTted image.

MORE TOOLS

This setting alternates the button on the Lower Tool Bar to the left of the HIDE button between the HISTOGRAM tool and the VECTORSCOPE tool.

Hide (*hide menus & screen overlays/ video*)

HIDE

While the Odyssey’s OLED screen provides an excellent image with intuitive touch screen controls and information displays, sometimes one does not want to see it all. The Hide function can be set to make either the controls & displays disappear or the video image go black. A tap anywhere on the screen brings the full display back.

Upper Tool Bar (Play Mode)

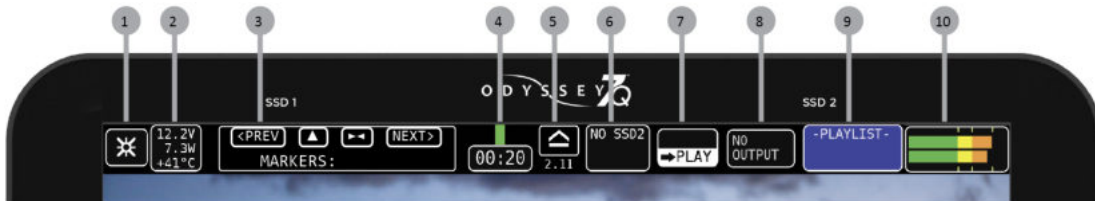

- 1 MENU BUTTON
- 2 SYSTEM STATUS
- 3 MARKER CONTROLS (*PLAY MODE ONLY*)
- 4 SSD1 STATUS
- 5 SSD SAFE EJECT
- 6 SSD2 STATUS
- 7 REC/PLAY TOGGLE
- 8 CLIP METADATA
- 9 PLAYLIST
- 10 AUDIO

Marker Controls (Play Mode Only)

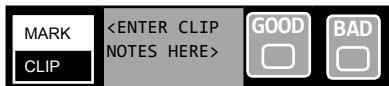

Clip Notes such as “Good Take” can be made for each clip. Text plus Good or Bad notes. Markers are flagged reference points within a file. Single flags as well as in/out points can be marked. Used in conjunction with the Convergent Design Apple ProRes Transfer Utility (1.4 or above) markers are translated into Final Cut 7 and FCPX .XML files. These can be imported into Final Cut 7, FCPX and Adobe Premiere. Up to 16 In and 16 Out points can be marked in a single clip, but more than one pair of In and Out points can only be read by FCPX.

Starting playback with an IN marker will automatically stop at its corresponding OUT marker. Select LOOP in Playlist to repeatedly play only the selected IN/OUT range.

Input-Output Status



Displays current SDI/HDMI output status and settings. Tapping button brings up detailed information on the Input/Output Status and allows selection of input and output settings.

Replication of INPUT/OUTPUT STATUS button from RECORD mode (for details see page 24).

Playlist (Play Mode Only)



Tapping button displays a list of recorded files. Files can be selected for playback and can be continuously played back in a Loop. Odyssey can only play up to 30p directly. 50p & 60p clips can be played back at 25p or 30p (half speed) but the audio will play back at normal speed, taking only half the time to play. Alternatively Skip Frames (50/60p) can be selected so that Odyssey will play back every other frame so that the clips play at proper speed and in sync with the audio.

	TYPE	FORMAT	INPUT	PROJECT	TIMECODE	TIME OF DAY
08	<input type="checkbox"/>	.MOV	1080I	29.97	29.97	00:00:00:02 08-JUL-14 06:48
09	<input checked="" type="checkbox"/>	.MOV	1080I	29.97	29.97	00:00:00:00 23-JUL-14 11:34
10	<input type="checkbox"/>	.MOV	1080I	29.97	29.97	00:00:00:02 23-JUL-14 11:35
11	<input type="checkbox"/>	.MOV	1080I	29.97	29.97	00:00:00:00 24-JUL-14 07:25
12	<input type="checkbox"/>	.MOV	1080I	29.97	29.97	00:00:00:00 24-JUL-14 12:45

MULTIPLE ALL LOOP

Multistream Quad-HD Monitoring

The Odyssey7Q+ supports monitoring of 1 to 4 HD video streams, using 4 SDI inputs (2x SDI In, 2x SDI IO). One input may be HDMI, which will replace SDI A automatically.

When monitoring, the four HD streams resolutions and frame rates do not need to match. The paid upgrade to the Apollo Option is not required for monitoring.

The four HD video inputs can each be viewed full screen or all viewed at once in a Quad-Split display. On the Lower Toolbar starting at the left, five buttons allow the selection of QUAD, A, B, C, or D views. The selected view is sent to the OLED screen as well as the HDMI output and two SDI outputs.

To activate the QUAD-HD Monitoring mode, select it in the RECORD Status button menu.

RECORD -> CAMERA -> AVAILABLE CAMERAS -> MULTI-STREAM -> QUAD-HD MONITORING

Apollo Mode Recording

Apollo modes allow monitoring and recording of multiple 4K or HD video signals simultaneously. Apollo Dual-4K enables the monitoring and recording of up to two 4K/UHD video signals simultaneously. Apollo Quad-HD enables the monitoring and recording of up to four HD video signals simultaneously. In Quad-HD, a fifth HD recording of a Quad-Split view of the four inputs or a Live-Switch between them is also available. Recordings are in Apple ProRes HQ, 422, or LT.

In Apollo Quad-HD, the device can also function as a four-channel live switcher while simultaneously recording the four isolated HD video signals. Both the Quad-View and the Live-Switch are available as live video outputs.

Apollo Mode requires the Apollo Option for Odyssey, a paid upgrade available for purchase or rental on the Convergent Design website. A demo-only version of the Apollo Option is available on the Odyssey7Q+ and Odyssey7Q for testing purposes.

To activate the Apollo mode, select APOLLO in the RECORD Status button menu.

RECORD -> CAMERA -> AVAILABLE CAMERAS -> MULTI-STREAM -> APOLLO QUAD-HD or APOLLO DUAL-4K

SUGGESTED USE

Apollo may be used for interviews, surveillance, analysis or other events where multiple camera angles are captured simultaneously. Before editing, recorded files can be viewed on Apollo and markers applied to note moments of interest. For an overview of the recorded files, the Quad-Split view can be recorded as a fifth track, and then this track monitored while reviewing the file.

Apollo Dual-4K

Apollo Dual-4K mode enables monitoring and recording of up to two 4K or UHD video inputs simultaneously. Resolutions and frame rates must match when recording. Supported frame rates are:

Single video signal:

4K or UHD at 23.98p, 24p, 25p, 29.97p, 30p, 50p, 59.94p, and 60p

Dual video signals:

4K or UHD at 23,98p, 24p, 25p, 29,97p, 30p

Dual-4K Inputs

On Apollo and the Odyssey7Q+, there are several ways that a 4K or UHD video signal can be input. The HDMI input accept DCI 4K (4096x2160) up to 24p or UHD (3840x2160) up to 30p. 6G-SDI for frame rates up to 30p is available on SDI A and SDI B inputs. Dual-Link 3G-SDI for frame rates up to 30p is available by pairing SDI A/SDI B and SDI C/SDI D inputs. Quad-Link 3G-SDI for frame rates up to 60p is available by using all four SDI inputs (A/B/C/D).



Dual-4K Monitoring

In Apollo Dual-4K, both images can be viewed using a Picture-in-Picture view, or each individual input can be separately viewed. Selection of the monitoring mode is located on the left on the Lower Toolbar. A/B represents the Picture-in-Picture mode, and A or B represent the individual inputs. The Picture-in-Picture view can be toggled between a/B and A/b, indicating which input is displayed in the larger v. smaller view. The PiP window can be positioned on the lower left or lower right corners of the OLED. To swap between a/B and A/b, tap the smaller image on the OLED touchscreen. The monitoring mode chosen equally effects the OLED touchscreen, the HDMI output, and the two SDI outputs. The video outputs are in 1080p.

Dual-4K Recording

Two 4K or UHD video signals can be recorded simultaneously. The resolution and frame rates must match. When recording two 4K or UHD signals, the maximum available frame rate is 30p. When recording only a single 4K or UHD signal, the maximum available frame rate is 60p. Dual-4K Recording supports up to 8 channels of audio (four channels per video signal). All eight channels are displayed in the Audio Meters on the right end of the Upper Tool Bar.

Additional Dual-4K Information

Please see Apollo Quad-HD and the rest of the Apollo manual section for information on LUTs, playback, Master Input, post procedures and other information.

Apollo Quad-HD

Apollo Quad-HD mode enables monitoring and recording of up to four HD video inputs simultaneously. A fifth HD recording of a Quad-Split view of the four inputs or a Live-Switch between them is also available. Resolutions and frame rates must match when recording. Supported frame rates are:

1080p at 23.98p, 24p, 25p, 29.97p, 30p, 50p*, 59.94p*, and 60p*

1080i at 50i and 59.94i

720p at 50p, 59.94p, 60p

* At 1080p above 30p, the fifth video track recording of a Quad-Split or Live-Switch is not available.

Quad-HD Monitoring

The four HD video inputs can each be viewed full screen or all viewed at once in a Quad-Split display. On the Lower Toolbar starting at the left, five buttons allow the selection of QUAD, A, B, C, or D views. These controls override all other switch controls and the selected view is sent to the OLED screen as well as the HDMI output and two SDI outputs.

Quad-HD Monitoring During Recording

In **A/B/C/D** and **A/B/C/D + Quad-Split** recording modes, the HDMI and SDI A OUT show the Quad-Split while the SDI B OUT shows the last button selected on the Lower Toolbar.

In **A/B/C/D + Live-Switch**, HDMI OUT shows the Quad-Split, SDI A OUT can show either the Quad-Split or the Preview selection, and SDI B OUT can show either the Quad-Split or the Program selection.

Input Naming

Apollo Quad-HD allows the four video inputs to be individually named. The names can be set to appear on the OLED touchscreen, output to the HDMI output and/or the SDI A output, and are recorded as metadata in the Apple ProRes recordings. To set the Input Names, press and hold the QUAD button on the Lower Toolbar. Names can be up to 30 characters in length. Tap the menu button to enable the names to appear on the OLED touchscreen. To enable names to appear on the HDMI and/or SDI A outputs, follow the LUT instructions in the next section to have those outputs “Mirror OLED”. Files must be transferred using the CD ProRes Transfer Tool version 2.2 or higher in order to properly output the names in metadata.

Focus Assist Access

Focus Assist is activated using the FOCUS button. This button is only available when the OLED menu is active, not when the QUAD button is in use. To allow easier access to the Focus Assist while in Quad-HD, there is the option to switch the HIDE button to a FOCUS button. This button is located on the right end of the Lower Toolbar. Hide/Focus selection is in the QUAD/OLED menu.

Monitor LUTs

Some video cameras can output a Log signal that flattens the contrast, allowing for the greatest range in exposure and color correction options in post. Apollo includes a number of preset LUTs for various model cameras that apply a standard color correction to the OLED and video outputs for a pleasing image while allowing the Log image to be recorded for later precision color correction.

On the Lower Toolbar, press and hold LUT.

Note that the QUAD SELECT buttons may be displayed on the Lower Toolbar. If so, press and hold the QUAD button to access a menu. Then select OLED+TOOLS to swap the button controls on the Lower Toolbar.

In the LUT menu, select the appropriate LUT for your cameras. You may also load custom 3D-LUTs that can be created on various color correction programs. Note that a single LUT will be applied to all camera inputs.

The LUT can be routed to the OLED screen, the Monitoring Tools as well as the three video outputs (HDMI OUT, SDI A OUT, and SDI B OUT). Press **CUSTOMIZE OUTPUTS** to select where the LUT will be applied. Note that selecting MIRROR OLED will also send Monitoring Overlays such as the Monitoring Tools and the Live-Switch reference frames to the selected output.

LUT Outputs

Apollo has three video outputs, **HDMI OUT**, **SDI A OUT**, and **SDI B OUT**. HDMI OUT will always show the Quad-Split. These outputs can be clean or have the OLED Overlays (Live-Switch reference lines and Monitoring Tools) appear using the LUT control even if no LUT is applied.

1. On the Upper Toolbar, press the INPUT/OUTPUT STATUS button.
2. Press OUTPUT STATUS.
3. Press CUSTOMIZE SDI A, CUSTOMIZE SDI B, and CUSTOMIZE HDMI to select LUT application.

HDMI Out options in Output menu:

LUT OFF (Quad-Split view with no LUT applied)

LUT ON (Quad-Split view with LUT applied)

MIRROR OLED (Quad-Split view with Preview/Program and other overlays)

SDI A Out options in Output menu:

LUT OFF (Quad-Split view with no LUT applied)

LUT ON (Quad-Split view with LUT applied)

MIRROR OLED (Quad-Split view with Preview/Program and other overlays)

LIVE-SWITCH PREVIEW (Preview input selection)

SDI B Out options in Output menu:

LUT OFF (Quad-Split view with no LUT applied)

LUT ON (Quad-Split view with LUT applied)

MIRROR OLED (Quad-Split view with Preview/Program and other overlays)

LIVE-SWITCH PROGRAM (Program input selection)

NOTE:

When any output is set to Mirror OLED, LUT application mirrors OLED

When SDI A Out is set to Live-Switch Preview, LUT is not applied

When SDI B Out is set to Live-Switch Program, LUT application mirrors OLED

Note that these controls mirror the CUSTOMIZE OUTPUTS controls in the LUT menu.

Quad-HD Recording

Apollo Quad-HD mode enables monitoring and recording of up to four HD video inputs simultaneously. A fifth HD recording of a Quad-Split view of the four inputs or a Live-Switch between them is also available. Resolutions and frame rates must match when recording. Supported frame rates are:

1080p at 23.98p, 24p, 25p, 29.97p, 30p, 50p*, 59.94p*, and 60p*

1080i at 50i and 59.94i

720p at 50p, 59.94p, 60p

- At 1080p above 30p, the fifth video track recording of a Quad-Split or Live-Switch is not available.
- 1080p sources can be a mix of Progressive (p) and Progressive Segmented Frames (psf).
- 3:2 Pulldown Removal is supported in Apollo. 3:2 Pulldown signals (1080p23.98 within 1080i59.94 or 1080p24 within 1080i60 streams) can be mixed with true 23.98/24p signals, with all recorded as 23.98p/24p. Note that 3:2 Pulldown Removal and A/V Align cannot be used at the same time.

All video and audio streams are recorded into a single multitrack QuickTime (.mov) file containing Apple ProRes (HQ, 422, or LT), in 1920x1080 or 1280x720 resolution. The CD Apple ProRes Transfer Tool is required for offloading Apollo files. Only one SSD is required for recording. Video sources can be a mix of HDMI and SDI and do not need to be genlocked.

To select the Apollo Quad-HD record mode:

RECORD STATUS -> RECORD STREAM -> APOLLO QUAD RECORD

If already in Quad-HD mode, select between:

A/B/C/D

A/B/C/D + LIVE SWITCH

A/B/C/D + QUAD SPLIT

Quad-HD Double Master Recording

Double Master Recording captures files simultaneously to two SSDs. This allows for an instant backup of recordings. Switch between spanning mode and Double Master mode in RECORD STATUS -> RECORD STREAMS. NOTE: Double Master Recording not available in frame rates above 1080p30.

Quad-HD Inputs

In Apollo Mode the Odyssey can record up to four HD video inputs simultaneously. If fewer inputs are used the Odyssey will not record blank extra files, so the available recording time is greater. There are five available inputs on the Odyssey, four SDI inputs (SDI A IN, SDI B IN, SDI A In/Out, SDI B In/Out) and one HDMI input. If the HDMI input is utilized it automatically overrides the SDI A input. A signal MUST be in place to either HDMI or SDI A.

Master Input

The Master Camera will determine the Camera trigger, and timecode for all files. Either the SDI A/HDMI input or the SDI B input can be selected as the MASTER INPUT. A camera feeding this input can be used to trigger recording and be the timecode source for the Apollo recording.

In Dual-4K mode, input A is HDMI, SDI A IN (Single-Link 6G-SDI), or SDI A/B (Dual-Link 3G-SDI). Input B is either SDI B IN (Single-Link 6G-SDI), or SDI C/D (Dual-Link 3G-SDI).

1. On the Upper Toolbar, tap the **RECORD STATUS** button.
2. Tap the **MASTER CAMERA** button to select from the list. This menu page can also be used to exit Apollo mode and return to Odyssey recording.
3. Tap the MASTER INPUT button to select SDI A/HDMI or SDI B.

Note that the MASTER INPUT does not have to be used to trigger recording or generate timecode. Tap RECORD TRIGGER to select trigger method (Record Button, Camera, Remote, Timecode). Tap the INPUT/OUTPUT STATUS button and tap TIMECODE SOURCE to select timecode type (SDI/HDMI, LTC, Time-of-Day D/ND, or Seed/Record Run)

Master Input Selection

Input A, either SDI Input A or the HDMI input is required at all times. Either the SDI A/HDMI input or the SDI B input can be selected as the MASTER INPUT. When desired, less than four video/audio streams may be supplied to the Apollo Option, provided at least the A input is provided. A camera feeding this input can be used to trigger recording and be the timecode source for the Apollo recording. In DUAL-4K mode, Input A is either HDMI, SDI A In (Single-Link 6G-SDI), or SDI A/B (Dual-Link 3G-SDI). Input B is either SDI B In (Single-Link 6G-SDI), or SDI C/D (Dual-Link 3G-SDI).

1. On the Upper Toolbar, tap the **RECORD STATUS** button.
2. Tap the **MASTER CAMERA** button to select from the list. This menu page can also be used to exit Apollo mode and return to Odyssey recording.
3. Tap the **MASTER INPUT** button to select SDI A/HDMI or SDI B.

The Master Camera will determine the Camera trigger, and timecode for all files.

Note that the MASTER INPUT does not have to be used to trigger recording or generate timecode. Tap RECORD TRIGGER to select trigger method (Record Button, Camera, Remote, Timecode). Tap the INPUT/OUTPUT STATUS button and tap TIMECODE SOURCE to select timecode type (SDI/HDMI, LTC, Time-of-Day D/ND, or Seed/Record Run).

Quad-HD Recording Live-Switch or Quad-Split

In addition to recording up to four simultaneous HD video signals, Apollo can also record a fifth channel as either a Live-Switch between the four inputs or a Quad-Split view of them. The Live-Switch and the Quad-Split are also both available as video outputs. The Quad-Split recording has a timecode window burn-in in the lower center of the image. This timecode window is an option for the video outputs but is always present in the Quad-Split recording.

1. On the Upper Toolbar, tap the **RECORD STATUS** button.
2. Tap the **RECORD STREAMS** button to select A/B/C/D, A/B/C/D + LIVE STREAM, or A/B/C/D + QUAD SPLIT. This menu page can also be used to exit Apollo mode and return to Odyssey recording.

Quad-HD A/V Align

Some camera designs can introduce latency to the video signal, delaying the video by a frame or two. This can sometimes delay audio as well, or audio can arrive before video. Mixing camera types can create out of sync recording in Quad-HD. A/V Align allows each input to individually delay the video signal and separately the audio signal. Video signals can be delayed up to four frames and audio signals can be delayed up to seven frames. By separately adjusting all eight parameters (four video signals, four audio signals), A/V Align can sync the inputs before recording and switching.

1. Record a clip with all cameras pointing at a single sync reference such as a clapper slate.
2. Switch Apollo to Playback and play clip to find the video sync point for input A. Tap A/V Align button and use <STEP & STEP> buttons to find input A video sync point.
3. Tap “Align Video: Track A” to set input A video sync point.
4. Using the Audio Meters on the Upper Toolbar, use <STEP & STEP> buttons to find input A audio sync point.
5. Tap “Align Audio: Track A” to set input A audio sync point.
6. Repeat steps for remaining inputs. Tap DONE when complete.
7. With A/V Align active, switch to Record and shoot another sync reference to verify A/V Align.
8. To turn on/off A/V Align, go to INPUT STATUS -> A/V ALIGN ON/OFF

Markers

Apollo Mode supports markers for up to 33 reference or in/out points. These Markers are part of an XML file that exports with the QuickTime file. Note that markers apply to all video tracks within a file and are based on the shared timecode of the file. Marker tool controls are located on the Upper Toolbar in Playback mode. In Quad-HD, Markers can be noted while recording. A Marker button replaces the Safe-Eject button in the center of the Upper Toolbar.

Audio

Quad-HD records 8-channel embedded audio per input from SDI sources, or 2-channel embedded audio from HDMI or 2-channel analog audio from the 3.5mm AUD IN socket near the bottom right corner of the unit. The Audio Meters will display the first two channels for each input.

Dual-4K records 4-channel embedded audio from SDI sources, or 2-channel from HDMI or AUD IN. The Audio Meters will display all four channels for each input.

1. On the Upper Toolbar, tap the AUDIO STATUS button (far right).
2. Tap the AUDIO SOURCE button to select SDI/HDMI or ANALOG AUDIO.

If Analog Audio is used, the audio will always be recorded to Input A.

Note that if recording Live-Switch or Quad-View, the SDI A/HDMI audio (either embedded or analog input) will be used for this recording. SDI B, SDI C, and SDI D will always record the embedded audio from the SDI stream.

Audio-Follows-Video

In Quad-HD Live-Switch, the audio recorded to the Live-Switch video track and embedded in the SDI B Out can be the SDI A/HDMI audio (either embedded or analog in) or it can be the audio from the selected video input. Most production work will use a constant audio source while conference and seminar work may wish to have the audio source switch automatically along with the video source. In Audio-Follows-Video mode, when switching inputs the audio will go silent for 21 milliseconds to smooth audio transitions.

1. On the Upper toolbar, tap the AUDIO STATUS button (far right).
2. Tap the LIVE SWITCH REC button to select RECORD AUDIO CHANNEL A or RECORD AUDIO FOLLOWS VIDEO.

Quad-HD Loss of Signal

In Quad-HD if one of the input signals is lost during recording, Apollo will continue to record the other video signals. When the lost signal returns, Apollo will reacquire it and resume recording of that track. Timecode sync will be maintained. While SDI A or HDMI input is required to begin recording, if lost during operation the recording of other tracks will continue and upon signal return Apollo will reacquire.

Record Times

See *Apollo Record Formats* chart on [page 11](#) of this manual for estimated record times.

Quad-HD Live Switching and Live Switch Recording

In the A/B/C/D + LIVE SWITCH recording mode, the Live-Switch interface is available. A selected PROGRAM input is recorded to the fifth Live-Switch channel and is also output to SDI B OUT. There are two Live-Switch modes, PROGRAM ONLY and PREVIEW/PROGRAM. Program Only is a single-tap operation and Preview/Program is a double-tap operation. Select Live-Switch mode in the QUAD menu.

PROGRAM ONLY: On the OLED panel, the selected input is indicated with a colored outline. When not recording the outline is GREEN; when recording the outline is RED. To switch to a different input, tap its image in the Quad-Split view on the OLED.

PREVIEW/PROGRAM: On the OLED panel, the selected input is indicated with a colored outline. When not recording the outline is GREEN; when recording the outline is RED. To switch to a different input, tap its image in the Quad-Split view on the OLED. One tap will place a YELLOW outline around the image, indicating that it is the PREVIEW selection. A second tap on the yellow-outlined image will switch it to PROGRAM. The PREVIEW selection can be changed to a different input by tapping that input's image without the PROGRAM feed being altered. When a selection is switched to PROGRAM, the input that was previously the PROGRAM channel automatically becomes the PREVIEW channel (outlined in YELLOW). In this way, two inputs can be switched between with a single tap.

Cuts and Dissolves

In Live-Switch, the transitions between inputs can be straight cuts or dissolves (aka FADE). Dissolves are available in three speeds: Slow (16 frames), Medium (8 frames), and Fast (4 frames). CUT/FADE and FADE SPEED can be selected in the QUAD Menu. During recording, the * button on the left end of the Upper Toolbar is replaced with a CUT/FADE button to quickly alternate between the two

Suggested Use

A suggested method for using Apollo in conjunction with its monitor outputs in Live-Switch mode:

SDI A OUT AS THE PREVIEW MONITOR - Set it to MIRROR OLED so that the PREVIEW and PROGRAM outlines are visible. Or set it to PREVIEW to view the Preview selection (Preview/Program switching).

INPUT/OUTPUT STATUS -> OUTPUT -> CUSTOMIZE SDI A -> MIRROR OLED

INPUT/OUTPUT STATUS -> OUTPUT -> CUSTOMIZE SDI A -> LIVE SWITCH "PREVIEW" OUT

SDI B OUT AS THE PROGRAM MONITOR – Use LUT button if recording Log signals.

INPUT/OUTPUT STATUS -> OUTPUT -> CUSTOMIZE SDI B -> LIVE SWITCH "PROGRAM" OUT

HDMI OUT AS CLIENT REFERENCE MONITOR - Apply a LUT if recording Log signals.

INPUT/OUTPUT STATUS -> OUTPUT -> CUSTOMIZE HDMI -> LUT ON/OFF

Playback

On the Upper Toolbar, press REC/PLAY to switch between RECORD and PLAYBACK modes.

The individual video inputs and the Quad-View or Live-Switch feeds are all recorded together as a single file. This makes all of the recorded tracks available for playback in parallel.

On the right side of the OLED screen are up to five buttons, depending on how many video tracks were recorded in a file. A, B, C, D, and LS (Live-Switch) or QS (Quad-Split) are available. Press one of these buttons to select which track to view in playback. Note that the entire file is played in parallel, so tapping a different button during playback will show the different video track in sync with that moment in the clip timeline. The file can also be paused and the different video tracks be switched between.

To view a fullscreen video source during playback simply select the camera in the lower right hand side of the screen (A,B,C,D,) or select QS to playback all four video streams in sync.

You may switch to any input video stream, Live-Switch (LS) or Quad-Split (QS) while playing back footage or when paused.

You may scrub through the footage while in playback mode, and you may jump to any position by just touching that position in the timeline area (lower right area of the bottom menu.)

Additional Notes:

All recorded sources will have the same codec. Apple ProRes HQ, 422, or LT.

The Metadata (Including the clip name) for all 5 streams is determined by the Odyssey. (The Metadata box is next to the audio bars - scene, take, roll etc.)

All recorded files will have the same timecode based on the master setting.

Camera A's audio can be Embedded Audio or external Analog Audio, as setup in the menu. Camera B's, C's, and D's audio will be the audio embedded in the HD-SDI Input stream. Each Camera stream can have two channels of audio embedded with the video.

Switching (Live Viewing)

To view a fullscreen video source, simply select the camera in the lower left hand corner of the screen (A,B,C,D). Or press QUAD to display a quad split of all connected video feeds.

Offloading

When recording in Apollo Mode, the multiple files are recorded into a single Quicktime file (1-5 streams). The 5 streams are embedded within each Quicktime (.mov) file. This is a legal “multi-track” Quicktime file. Multi-track Quicktime files have limited support in viewers and editors on a computer.

The CDProRes Transfer Tool allows for full support and compatibility of Odyssey Quad recordings with all video editing software.

It is NECESSARY to use the CD ProRes Transfer Tool v2 in order to take the original file that contains all (up to 5) video and Audio Tracks and separates these into 5 individual Quicktime files.

A given original stream is entirely contained within a given file, and all files have the same starting timecode. This allows for editors to more readily accept the multi-stream recording.

The Odyssey file system is FAT32 based, therefore this Utility allows you to combine spanned files up to 512GB in size. The tool will also allow you to copy all recorded ProRes files from their clip directories to one directory.

The tool will also optimize files for use with Final Cut Pro X

The tool will transfer playback markers, to the ProRes files, so they can be ready by most NLE's (For all 5 streams) *(This feature is in development and will be available in a future release.)*

Quicktime Player Pro 7

Individual video tracks can be viewed with the use of Quicktime Player Pro 7, using the Movie Inspector. to view each track individually.

CD Apple ProRes Transfer Tool

Apollo files are recorded as a single multitrack QuickTime file. All Apollo files must be processed using the CD Apple ProRes Transfer Tool.

The CD Apple ProRes Transfer Tool v2.4 separates the video/audio tracks into individual Apple ProRes files with matching filenames and timecode. Input naming is included in the Apple ProRes metadata.

The CD Apple ProRes Transfer Tool v2.4 is designed to offload Odyssey-recorded Apple ProRes files and also functions for offloading Apollo multitrack files. Supported file formats include Apple ProRes 4444(XQ)/4444/422(HQ)/422/422(LT), Apollo multitrack files as well as Markers & Notes (exported as FCPXML for use with FCP7, FCP-X, Adobe Premiere, and Resolve 10 and above). Windows and MAC OS versions available.

The CD Apple ProRes Transfer Tool v2.4 provides the option to only download select video/audio tracks. In Quad-HD, all inputs are always recorded, including when also recording the Live-Switch or Quad-Split. This is to prevent a client from accidentally not recording a desired track. By transferring only desired tracks, transfer time can be greatly reduced and all of the original tracks are retained on the SSD until it is reformatted.

Note that the CD Apple ProRes Transfer Tool can be used to offload directly from an SSD to reduce post process steps, or can be used to process files already offloaded on a computer. While not required, offloading files from SSDs using this tool is a more efficient workflow than other methods.

The CD Apple ProRes Transfer Tool and other software utilities are available for download in the software/utilities section of our website at <https://convergent-design.com/software.html>

Installation Instructions

1. Download the CD Apple ProRes Transfer Tool v2.4 installation files from the Convergent Design website on the SOFTWARE/UTILITIES page at
2. Decompress the zip file and open up the ProRes Transfer folder.
3. Run the ProResTransfer.jar application.

Note: The ProRes Transfer Tool uses Java. Mac users need to download and install Java JRE 1.6 from the Apple website here: <http://support.apple.com/kb/DL1572>

Other functions of the CD Apple ProRes Transfer Tool:

File spanning - Clips are broken into 4GB partitions. The Tool restores files seamlessly to original capture size. Files can be up to 2TB, the maximum recording size currently available for Odyssey/Apollo.

Concatenation across multiple files - for lengthy recordings, multiple files may be created for a single take on an SSD, due to the 4GB file size limit on the Odyssey.

For Apollo Mode Recording this is also true: in this case multiple multi-track files may be created for a single recording.

For each of the 5 streams, the tool concatenates clips that extend beyond 1 file into a single file.

Splitting out the streams - the tool splits out the 5 tracks within a single multi-track file into 5 separate files.

A given original stream is entirely contained within a given file, and all files have the same starting timecode.

This allows for editors to more readily accept the multi-stream recording.

Optimizing for FCP-X - In/Out & Marker points are output in FCP XML format.

File Management - Files can be copied from various clip directories to a single directory.

The CD Apple ProRes Transfer Tool can be used as the program to offload media from an Odyssey SSD, making the process seamless and a single step. If files are already loaded onto a computer, the Tool can be used to process files and group them into directories.

CHOOSE A SOURCE

Tap “...” box on right to open a window and select the source files from the SSD or transferred material on computer. To select the entire contents of an SSD, select “}CLIP{____ODYSSEY” folder. Drag & drop selected file or folder into window under SOURCE.

CHOOSE A DESTINATION

Tap “...” box on right to open a window and select a destination on your computer. Drag & drop selected destination into window under DESTINATION.

Click **TRANSFER** to begin operation.

Note that for Apollo multitrack files, separated files from the original multitrack file will have matching timecode and filenames with connective extensions. The Transfer Tool extracts the Apollo Mode Input Name metadata and inserts it into the individual Apple ProRes file metadata header.

Using the CD ProRes Transfer Tool with Apollo Mode Files

Odyssey 7Q, 7Q+, and Apollo ProRes files have a 4GByte size limit within the Odyssey and Apollo, therefore any ProRes recording on the Odyssey or Apollo that exceeds approximately 2 1/2 minutes will create more than one ProRes file for that clip. Each 4 Gigabyte file will have a “_###” appended to the individual clip name. As shown here:

Windows:

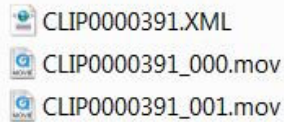

Mac:

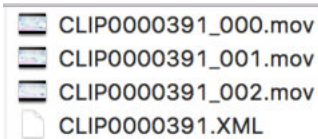

This tool creates a single file for each ProRes clip rather than multiple files. This tool also optimizes Odyssey7Q, 7Q+, and Apollo ProRes files for playback efficiency on a computer and in editors. It also provides the option to set a maximum file size in the combining process, if extremely large files are not wanted or if smaller files are wanted.

Java Required: Java software must be installed on your computer to run this tool.

1) Choose Source (Drag and Drop, or File Chooser Dialog)

Choose a source drive or folder for copying/combining files.

You may choose the “}CLIPS{_____ODYSSEY” or “}CLIPS{_____APOLLO” top folder on the Convergent Design SSD, and all clips on the SSD will be processed.

Windows:

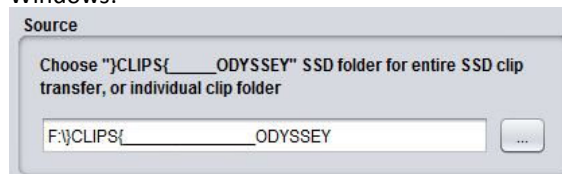

Apollo Mode Post Workflow

Mac:

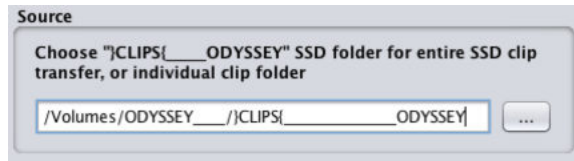

Or you may choose an individual ProRes clip folder, if you prefer.

Windows:

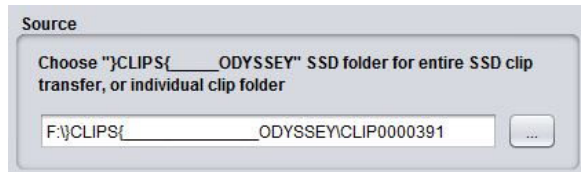

Mac:

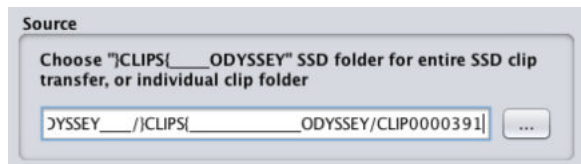

2) Choose Destination (Drag and Drop, or File Chooser Dialog)

Choose a destination folder for your copied/combined/optimized clip files.

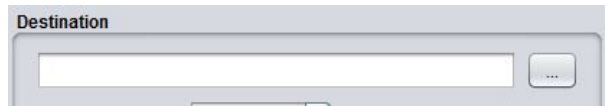

Ensure that sufficient room is available on the destination drive for all the data.

3) Choose Maximum File Size (Defaults to 512 GBytes)

If you prefer to limit the maximum file size of your combined clip files, adjust **Maximum file size**. Default size is 512GB. If a given clip's files reach beyond the maximum file size then multiple files will be generated for that clip in the copy/combine process.

4) Choose Project Rate (Defaults to that specified on the Odyssey or Apollo)

If you wish you can change the project rate as you transfer the .mov files. The default is the rate that was specified on the Odyssey or Apollo.

5) Choose whether to Place all transferred clips into the same folder

When this option is selected: All transferred Quicktime files will be placed into the selected destination folder, instead of individual clip folders (as they are originally stored on the Odyssey or Apollo). This allows for easier importing of multiple files at once into editors. Auxiliary .xml files are placed into a separate "xml" folder.

6) Choose whether to Place all BAD marked clips in a separate subfolder

When this option is selected: All clips that were explicitly marked as BAD on the Odyssey or Apollo are processed and placed in a separate BAD_CLIPS subfolder.

7) Choose “Transfer”

Choose the Transfer button to process the selected clip or clips. A progress bar will appear to indicate status, and a log file will be created in the destination folder with details of the transfer.

You will be prompted when the transfer is complete.

Note: all Odyssey or Apollo ProRes files in the Source will be processed and copied/combined/optimized to the Destination, any non-ProRes files encountered will be copied as is.

Here we see the results of the transfer :

Windows:

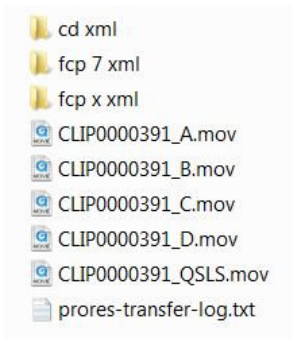

Mac:

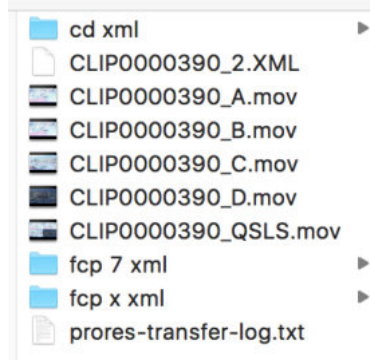

Each camera or video feed input has its own .mov file designated _A / _B / _C / _D as shown above – the _QSLS movie file is generated when the option for Live Switch or Quad Split is enabled on the Odyssey / Apollo. If HDMI is one of the video feeds, then it will in be the _A file.

Recording to SSD Media

The SSDs will automatically Span from SSD1 to SSD2. This means that if a file is recording to SSD1 and fills the available memory, the recording will continue uninterrupted on SSD2. The exception to this is when recording in a high data rate mode that requires both SSDs to be recorded to simultaneously, such as FS700 Record Option, 2K RAW @ 240fps. For more information on record times and SSD capacity, see Record Time Capacities.

Loss of Power During a Record

You should never power off the camera while recording. Many camera's including the ALEXA, disable the user from doing so while recording. Included in the Odyssey is a recovery mechanism. In case of power loss, you may lose the last few frames of the recording, but not the entire last take. You will receive several error messages due to the loss of source. If the unit fails to close the last clip and return to normal operation once the source has returned, you will need to remove the power from the unit, then re-power the unit. After any failure of this type, the device will automatically mark the SSDs as full, once power is restored to the unit. You will need to offload the footage before you will be able to continue recording in order to help ensure proper recovery of the previous recordings.

Downloading Media

Always make sure to properly Safe Eject to dismount SSDs before removing from Odyssey.

SSDs for the Convergent Design Odyssey and Apollo monitor/recorders utilize a standard 2.5" SATA interface. No expensive proprietary download stations are required. Consumer card adapters are available with Thunderbolt or USB 3.0 interface. Thunderbolt is fastest and USB 3.0 is most common. Please note that while USB 3.0 adapters will function on USB 2.0 ports, they will have much slower data transfer rates and take many hours to transfer data. Firewire 800 is not recommended as it will also take a very long time to download files.

Some USB 3.0 adapters have poor power efficiency and have been shown to have issues transferring Convergent Design files. Convergent Design offers a USB 3.0 SSD Adapter (CD-SSD-USB3-ST) through authorized dealers and distributors. This device allows you to access files on the Convergent Design SSDs on any computer with a USB 3.0 port. It will power off the USB 3.0 port without need for additional power."

After Safe Ejecting an SSD from the Odyssey7Q+ and mounting it to a computer, it is important to copy all files you wish to save. After copying all desired files, the SSD should be remounted in the Odyssey7Q+ and reformatted. **DO NOT RESUME RECORDING ON THE SSD WITHOUT FIRST REFORMATTING.** Many computers will automatically load hidden files onto the SSD that can adversely affect performance and clip file numbers might be repeated. If the SSD is reloaded and not reformatted then new files recorded may be unrecoverable.

If an SSD is Safe Ejected from an Odyssey7Q+ and then remounted in the Odyssey without having been connected to a computer, then recording to the SSD can continue without issue.

OTHER FILES ON SSD MEDIA

In addition to holding recorded files from the Odyssey7Q+, the SSDs are used to load data onto the Odyssey monitor/recorder. Periodic firmware updates can be downloaded from the Convergent Design website and copied onto an SSD, which when mounted in the Odyssey7Q+ will initiate the update process. Custom 3D-LUTs can be created in various programs and converted for use in the Odyssey7Q+ using the CD 3D-LUT Converter App. These LUT files can be copied onto an SSD, which when mounted on an Odyssey7Q+ will be available to then be saved into the internal memory using the LUT menu system.

It is recommended not to keep such files stored on SSDs you will be using for recording files from the Odyssey7Q+. Folders holding such files can be stored on your computer or on a separate CD-compatible SSD.

File Storage

The Odyssey SSDs support read rates of 500 Mbytes/sec. Keep in mind you will be limited by the slowest media in the transfer process. For example: eSATA 3GBps interface cards have a max performance of ~270Mbps, and eSATA 1.5GBps have a max performance of ~130Mbps. Typical Hard Drives (non-RAID) generally perform anywhere in the range of 80-130Mbps. For maximum performance, make sure you are using eSATA 6 GBps, USB 3.0 or Thunderbolt to a RAID configuration.

Video Format	Video Data Rate	Suggested RAID Configuration Real Time Playback/Edit
ARRI/2K/1080p24 4:4:4 10-Bit DPX	186.6 MB/Sec.	300
1080p25 4:4:4 10-Bit	194.4 MB/Sec.	300
1080p30 4:4:4 10-Bit	233.3 MB/Sec.	400
1080p50 10-Bit	400 MB/Sec.	600
1080p60 10-Bit	500 MB/Sec.	600
HD Compressed Apple ProRes 422	30MB/Sec.	100
2K RAW 23.98-120	500 MB/Sec.	600
4K RAW 23.98-29.97	500 MB/Sec.	600
4K RAW 50/60p 2K 200/240p	850 MB/Sec.	1000

Convergent Design has free file utility programs, CD Transfer, CD Clip Merger, CD ProRes Transfer Tool and CD 3D-LUT Converter available for download for both Mac & PC on our website.

<https://convergent-design.com/support/firmware-downloads/software-utilities.html>

CD Data Unpacker

Higher frame rate 8-12-bit (1920x1080, 2048x1080) DPX files are recorded in “Packed” files. CD Data Unpacker Utility copies and converts 1080p/59.94 and 1080p/60 DPX files and clips. The DPX files are converted from a “Packed” to “Unpacked” data format. Other DPX frame rates and other files formats do not need unpacking.

CD Clip Merger

Some high data rate formats need to be striped (aka RAIDed) across two SSDs when recording in the Odyssey. After offloading these file folders onto a local drive on a computer, CD Clip Merger combines matching RAIDed folders into single file folders.

Odyssey RAIDed recording formats include ARRIRAW 4:3 @ 48fps and Sony FS700 2K RAW @ 200fps and 240fps.

Basic Instructions for Using CD Clip Merger Software

1. Create a folder to hold your footage on our Hard Disk Drive or Raid System, giving it a name meaningful to you, such as “Project Name - Camera A - 2013-09-12”
2. Open the }CLIPS{ _Odyssey folder on your first SSD and copy all of the folders to the folder created in Step 1. Do not copy the folder itself, copy the contents of the folder.
3. Open the }CLIPS{ _Odyssey folder on your second SSD and copy all of the folders to the folder created in Step 1. Do not copy the folder itself, copy the contents of the folder.
4. Run the CD Clip Merger Program.

Additional instructions are available in the “Readme” file included in the download.

CD Apple ProRes Transfer Tool

Apollo files are recorded as a single multitrack QuickTime file. All Apollo files must be processed using the CD Apple ProRes Transfer Tool.

The CD Apple ProRes Transfer Tool v2.4 separates the video/audio tracks into individual Apple ProRes files with matching filenames and timecode. Input naming is included in the Apple ProRes metadata.

The CD Apple ProRes Transfer Tool v2.4 is designed to offload Odyssey-recorded Apple ProRes files and also functions for offloading Apollo multitrack files. Supported file formats include Apple ProRes 4444(XQ)/4444/422(HQ)/422/422(LT), Apollo multitrack files as well as Markers & Notes (exported as FCPXML for use with FCP7, FCP-X, Adobe Premiere, and Resolve 10 and above). Windows and MAC OS versions available.

The CD Apple ProRes Transfer Tool v2.4 provides the option to only download select video/audio tracks. In Quad-HD, all inputs are always recorded, including when also recording the Live-Switch or Quad-Split. This is to prevent a client from accidentally not recording a desired track. By transferring only desired tracks, transfer time can be greatly reduced and all of the original tracks are retained on the SSD until it is reformatted.

Note that the CD Apple ProRes Transfer Tool can be used to offload directly from an SSD to reduce post process steps, or can be used to process files already offloaded on a computer. While not required, offloading files from SSDs using this tool is a more efficient workflow than other methods.

The CD Apple ProRes Transfer Tool and other software utilities are available for download in the software/utilities section of our website at [Convergent-Design.com/software-utilities](https://convergent-design.com/software-utilities).

Installation Instructions

1. Download the CD Apple ProRes Transfer Tool v2.4 installation files from the Convergent Design website on the SOFTWARE/UTILITIES page at
2. Decompress the zip file and open up the ProRes Transfer folder.
3. Run the ProResTransfer.jar application.

Note: The ProRes Transfer Tool uses Java. Mac users need to download and install Java JRE 1.6 from the Apple website here: <http://support.apple.com/kb/DL1572>

Apollo Multitrack Files

Apollo files are recorded as a single multitrack QuickTime file. Convergent Design is working with NLE manufacturers to support this file standard, which will allow all tracks to drop directly onto a multi-camera timeline in sync. This file format will be available as an output from this Tool in a future update.

The CD Apple ProRes Transfer Tool separates the tracks into individual Apple ProRes files with matching filenames and timecode. All Apollo files must be processed using the CD Apple ProRes Transfer Tool.

Other functions of the CD Apple ProRes Transfer Tool:

File spanning - Clips are broken into 4GB partitions. The Tool restores files seamlessly to original capture size. Files can be up to 2TB, the maximum recording size currently available for Odyssey/Apollo.

Optimizing for FCP-X - In/Out & Marker points are output in FCP XML format.

File Management - Files can be copied from various clip directories to a single directory.

The CD Apple ProRes Transfer Tool can be used as the program to offload media from an Odyssey SSD, making the process seamless and a single step. If files are already loaded onto a computer, the Tool can be used to process files and group them into directories.

Choose a SOURCE

Tap “...” box on right to open a window and select the source files from the SSD or transferred material on computer. To select the entire contents of an SSD, select “}CLIP{____ODYSSEY” folder. Drag & drop selected file or folder into window under SOURCE.

Choose a DESTINATION

Tap “...” box on right to open a window and select a destination on your computer. Drag & drop selected destination into window under DESTINATION. Click TRANSFER to begin operation.

Note that for Apollo multitrack files, separated files from the original multitrack file will have matching timecode and filenames with connective extensions. The naming convention is as follows:

Source file:

Clip001

Separated files:

Clip001_A

Clip001_B

Clip001_C

Clip001_D

Clip001_QSLS

The QSLS file will only be present if either Quad-Split or Live-Switch was selected for recording.



CD 3D-LUT Converter

Convert 3D Look Up Table (LUT) files in .cube format to Convergent Design binary file format for use in the Odyssey7Q and Odyssey7Q+ monitor/recorders. Appropriate .cube files can be created in programs such as DaVinci Resolve and Pomfort LiveGrade. 3D-LUTs can be accepted in 17x, 33x, 48x and 65x formats.

Versions are available for Mac and Windows. The CD 3D-LUT Converter is a Java-based utility and Java software is required to be installed on the host computer to run the program. The Mac version requires Java JRE1.6 or higher and the Windows version requires Java JRE6 or higher.

Working with Recorded Files

There are numerous post systems and NLEs that can read natively the various file formats recorded by the Odyssey. Some NLEs may require plug-ins in order to read certain file formats. Blackmagic Design Resolve software is available for free and can read all formats recorded by the Odyssey.

File Structure

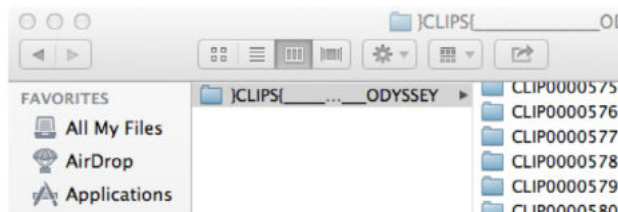

Uncompressed Support (DPX sequence)

All Uncompressed recordings on the Odyssey are recorded as 10 bit RGB 4:4:4 DPX, this is for all sources regardless if the source is 8 bit, 10 bit, 4:2:2, 4:4:4. With 12 bit cameras the files are recorded as a 16 bit DPX, for more universal compatibility. Also note that with DPX files, timecode and Clip Metadata are stored in every frame, as well as in the XML file within each clip. All audio is recorded 48Hz 16 bit Uncompressed WAV audio.

Also Note 1080p59.94/60p, 1080p119/120 and 12 bit files are recorded as Packed, so our CD unpacker utility will need to be used before the files can be used in any editor.

NATIVE 10-BIT / 16-BIT DPX SUPPORT

Adobe CS6 / Adobe CSCC/2014	Black Magic DaVinci Resolve	Grass Valley Edivis (Does not support 16-Bit)
Apple Color	Cineform Studio	The Foundry Nuke
AutoDesk Smoke	ColorFront OnSet Dailies	Xnview(Does not support 16-Bit)
Assimilate Scratch Lab	DJViewer	
Avid DS	Eyeon Fusion	

PLUGINS FOR DPX SUPPORT

Glue Tools
Apple FCP Pro
Apple FCP Pro X
Meta Fuse
Avid Media Composer

Apple ProRes

The Odyssey can record in Apple ProRes 422 (HQ), Apple ProRes 422 and Apple ProRes 422 (LT) compressed codecs. This allows for high quality recording while avoiding high data rates of working with uncompressed video.

Apple ProRes 4444 XQ	The highest-quality version of Apple ProRes for 4:4:4:4 image sources (including alpha channels), and provides the following: <ul style="list-style-type: none">• Target data rate of approximately 500 Mbps for 4:4:4 sources at 1920 x 1080 and 29.97 fps• The highest quality Apple ProRes
Apple ProRes 4444	An extremely high-quality version of Apple ProRes for 4:4:4:4 image sources (including alpha channels), and includes the following: <ul style="list-style-type: none">• Target data rate of approximately 330 Mbps for 4:4:4 sources at 1920 x 1080 and 29.97 fps• Perceptually indistinguishable from the original material
Apple ProRes 422 (HQ)	The Apple ProRes 422 (HQ) codec offers the utmost possible quality for 4:2:2 or 4:2:0 sources (without an alpha channel) and provides the following: <ul style="list-style-type: none">• Target data rate of approximately 220 Mbps (1920 x 1080 at 60i)• Higher quality than Apple ProRes 422
Apple ProRes 422	The Apple ProRes 422 codec provides the following: <ul style="list-style-type: none">• Target data rate of approximately 145 Mbps (1920 x 1080 at 60i)• Higher quality than Apple ProRes 422 (LT)
Apple ProRes 422 (LT)	The Apple ProRes 422 (LT) codec provides the following: <ul style="list-style-type: none">• Roughly 70 percent of the data rate of Apple ProRes 422 (smaller file sizes than ProRes 422)• Higher quality than Apple ProRes 422 (Proxy)

NATIVE APPLE PRORES SUPPORT

Adobe CC 2014*
Apple FCP X, Aperture
Cineform Studio

Final Cut Pro 7
Black Magic DaVinci Resolve
The Foundry Nuke

Autodesk Smoke
Sony Vegas

FS5/FS7/FS700 RAW Support (DNG Sequences)

All FS5/FS7/FS700 RAW recording on the Odyssey is recorded as a 12-bit linear CinemaDNG file. With DNG files, timecode and clip metadata is stored in every frame, as well as in the XML file within each clip. All audio is recorded 48Hz 16 bit Uncompressed WAV audio.

It is important to correctly set the white balance of the camera, as this is baked into the RAW file.

FS5/FS7/FS700 RAW in DaVinci Resolve, Premiere, & Importing 3D-LUTs

Detailed tutorial documentation and instructional videos are available on the Convergent Design website.

Canon C500/C300mkII 4K RAW Support

All Canon C500 & C300mkII 4K recording on the Odyssey is recorded as 10 bit Cinema RAW file.

Also note that with RMF files timecode, and Clip Metadata is stored in every frame, as well as in the XML file within each clip. All audio is recorded 48Hz 32 bit Uncompressed WAV audio.

It is important to correctly set the white balance of the camera, as this is baked into the RAW file.

NATIVE CINEMA RAW SUPPORT

Assimilate Scratch Lab
Adobe CC 2014

Black Magic DaVinci Resolve

Canon Cinema RAW Development

ARRI Alexa ARRIRAW Support

All ARRI Alexa ARRIRAW recordings on the Odyssey are recorded as 12 bit ARRIRAW file, also NOTE that with ARRI files Timecode, and Clip Metadata is stored in every frame, as well as in the XML file within each clip. All audio is recorded 48Hz 16 bit uncompressed WAV audio.

NATIVE ARRIRAW SUPPORT

Adobe CS6 / Adobe CSCC 2014
AutoDesk Smoke
Assimilate Scratch Lab

Black Magic DaVinci Resolve
Cineform Studio
Eyon Fusion

The Foundry Nuke
ColorFront OnSet Dailies

For a more extensive list on ARRIRAW and workflow please visit ARRI's website at:

http://www.ari.com/camera/digital_cameras/workflow/working_with_ariRAW/recording/ariRAW_t_link/

Convergent Design Accessories

View all Convergent Design Accessories on our website at Convergent-Design.com/accessories. All Convergent Design products are available through our worldwide dealer network. Visit us online at Convergent-Design.com/dealers to find our nearest authorized dealer

Power Supply Options

The Odyssey can accept DC power ranging from 6.5-34v. This means that small camcorder batteries, large camera bricks and even large block batteries or belts can be used to power the device. Depending on monitor and record modes, the power draw from the Odyssey can range from 8-15w. Even small camcorder batteries can power the Odyssey for several hours.

The Odyssey is supplied with a Convergent Design AC power supply. This is a universal switching power supply that can be used throughout the world, and comes complete with several interchangeable plug connectors. Only use a Convergent Design AC power supply on the Odyssey.

Odyssey Replacement AC Power Supply

[CD-OD-AC-PS](#)

The Odyssey uses a Neutrik 3-pin connector for power input. Convergent Design has modified this connector for reliability, strength, and protection from shorting. Convergent Design supplies cables to 3rd party manufacturers of battery plates and other Odyssey accessories.

ONLY USE A CONVERGENT DESIGN POWER CABLE ON THE ODYSSEY.

Optional Power Cables

Anton Bauer D-Tap 12v power cable to Odyssey (18")

[CD-OD-DTAP](#)

XLR-4 (generic 12v) power cable to Odyssey (18")

[CD-OD-XLR](#)

Fischer-3 (ARRI 24v) power cable to Odyssey (18")

[CD-OD-Fischer](#)

Flying lead (bare wire pigtail) power cable to Odyssey (36")

[CD-OD-Flying](#)

Battery Plate Options

Convergent Design offers a series of rear plates for the Odyssey that accept various manufacturers' small camcorder batteries.

Odyssey battery plate for SONY L-Series batteries

[CD-OD-SLPlate](#)

Odyssey battery plate for SONY U-Series batteries

[CD-OD-SUPlate](#)

Odyssey battery plate for Canon BP-9x Series batteries

[CD-OD-CBPlate](#)

Odyssey battery plate for Panasonic CGA-Series batteries

[CD-OD-PCGAPlate](#)

Odyssey battery plate for JVC Camcorder-style batteries

[CD-OD-JVCplate](#)

Teradek Battery Plates

Convergent Design also makes battery plates that can also hold and power a pair of Teradek Bolt video receivers along with the Odyssey. Two camcorder batteries (one for the Odyssey, one for the Teradeks) are used or a single large battery. These plates are shipped in kits that include short SDI cables and power cables for the Odyssey and Teradeks.

Teradek battery plate for 2x Sony L-Series batteries

[CD-OD-BOLT-SLPLATE](#)

Teradek battery plate for 2x Sony U-Series batteries

[CD-OD-BOLT-SUPLATE](#)

Teradek battery plate for 2x Canon BP-9x Series batteries

[CD-OD-BOLT-CBPLATE](#)

Teradek battery plate for 2x Panasonic CGA-Series batteries

[CD-OD-BOLT-PCGAPLATE](#)

Teradek battery plate for IDX V-mount batteries

[CD-OD-BOLT-IDXPLATE](#)

Teradek battery plate for Anton Bauer 3-stud batteries

[CD-OD-BOLT-ABPLATE](#)

Odyssey Sun Hood

The Convergent Design Odyssey Hood is a sturdy, but flexible three-sided sunshade specifically designed for the Odyssey. The hood attaches to the side 1/4-20 mount sockets on the Odyssey. If there is another item such as a mount that uses these side sockets, the Odyssey Hood's bolts can be removed and the other item's bolts can be passed through the Hood into the Odyssey. The Odyssey Hood folds flat for storage and can rest atop the Odyssey within the Odyssey Case. When the Hood is folded the mounting bolts do not protrude long enough to make contact with any surface, so as not to scratch the Odyssey screen in transport.

Odyssey Sun HOOD

[CD-OD-HOOD](#)

Odyssey Aluminum Table Stand

The Convergent Design Odyssey Aluminum Table Stand attaches to the Odyssey. While only five ounces, it is tall enough to protect the cables and connectors attached to the bottom of an Odyssey. The design tilts back the screen for comfortable viewing while also centering the weight over the stand for balance.

The stand can support an Odyssey alone or with any Convergent Design battery mount with full clearance and stability. There is also a standard 5/8" socket with tie-down bolt to mount the stand onto a standard light stand or baby pin. The stand also functions as a "chest offset" when an Odyssey is worn with a neck strap so the operator doesn't have to look uncomfortably straight down.

Odyssey Aluminum Table Stand

[CD-OD-AL-TS](#)

Odyssey Protective Case

The Convergent Design Odyssey Case is based on a Nanuk 910 case with custom foam insert. The use of precision-cut rigid foam means less is needed for protecting the gear. The main cutout for an Odyssey includes removable layers of rigid foam to allow the Odyssey to fit snugly when bare or with a variety of battery plates and 3rd party accessory mounts. This includes all Convergent Design mounting plates, including the Teradek Bolt Adapter Plate, complete with wireless receivers mounted and all cables plugged in. An additional cutout is large enough to hold SSDs, cables, USB adapter, batteries, Teradek Bolt transmitters, etc.

Odyssey Protective Case

[CD-OD-CASE](#)

Odyssey Ultra-Thin-SDI Cable

The Odyssey Ultra-Thin SDI Cable is a flexible and lightweight cable for use with the Odyssey. The SDI cable is rated for 3G signals and is useful in camera-mounted installations where its thinness and flexibility will help keep it out of the way for operators. Despite its small size, the SDI Cable is quite rugged and can even be tied in knots without effecting performance. Standard lengths are 18" and 36" with custom lengths available by special order.

Odyssey Ultra-Thin SDI Cable

[CD-OD-SDI](#)

Odyssey SSD to USB 3.0 adapter

To connect an SSD to a computer for downloading files, the computer needs to be able to mount an eSata 2.0 connection. For computers without such connectivity, the Convergent Design SSD to USB 3.0 Adapter is an inexpensive cable-style adapter to allow the SSD to connect to a USB 3.0 port. 6Ghz transfer speed. The Convergent Design USB3.0 Adapter is powered fully by the USB 3.0 connection and supports all SSDs allowed for use with Odyssey and Apollo devices. An SSD to USB 3.0 Adapter is included with the Odyssey7Q+ and Apollo. Additional units are available for purchase.

NOTE: While the Convergent Design USB 3.0 Adapter can be connected to a USB 2.0 port, download speeds will be extremely slow, requiring many hours to offload an SSD.

Convergent Design SSD to USB Adapter

CD-SSD-USB3-ST

ODYSSEY/APOLLO SCREEN PROTECTORS

The Convergent Design Odyssey Screen Protector is a stick-on/peel-off clear shield for the glass screen on the Odyssey. It includes the inked labeling for the connectors and controls on the device. This is a replacement item for the screen protector that ships installed on the Odyssey.

Replacement Odyssey7 Screen Protector

[CD-OD-SP7](#)

Replacement Odyssey7Q Screen Protector

[CD-OD-SP7Q](#)

Replacement Odyssey7Q+ Screen Protector

[CD-OD-SP7QPLUS](#)

Replacement Odyssey7Q+ (Anti-Glare) Screen Protector

[CD-OD-SP-AG-7QPLUS](#)

Replacement Apollo Screen Protector

[CD-OD-SP-APOLLO](#)

Replacement Apollo (Anti-Glare) Screen Protector

[CD-OD-SP-AG-APOLLO](#)

<http://convergent-design.com/accessories/85-odyssey-screen-protector.html>

ODYSSEY MICROFIBER CLEANING CLOTH

Cloth for cleaning the Odyssey screen

[CD-OD-MFC](#)

For information on where to buy these accessories and other Convergent Design products please visit the Dealers section of our website at [Convergent-design.com/dealers](http://convergent-design.com/dealers).

ODYSSEY Remote Trigger

The Convergent Design Odyssey Remote Trigger is a pushbutton active remote start/stop trigger for Odyssey monitor/recorders. The trigger button illuminates while recording. The trigger plugs into the RMT port on the left side of the Odyssey and comes in a six foot standard cable length. Custom cable lengths and breakout cables for triggering multiple Odysseys are available for special order.

Odyssey Remote Trigger

[CD-OD-REMOTE](#)

Third Party Accessories

Convergent Design works with numerous manufacturers for additional support products for the Odyssey Monitor/Recorders. While we have provided information and support, Convergent Design makes no claim and accepts no responsibility in the use of these products. These products are available through these manufacturers' own dealers.

See the complete list with links to the manufacturers' websites at [Convergent-Design.com/accessories#third-party](http://convergent-design.com/accessories#third-party).

Firmware Version 2016.06

NEW FEATURES: APOLLO & APOLLO OPTION (ODYSSEY7Q+/7Q)

DUAL-4K/QUAD-HD: MULTI-STREAM AUDIO METERS

- Dual-4K: Audio meters are displayed for the first four channels of each input
- Quad-HD: Audio meters are displayed for the first two channels of each input
- Expanded controls & descriptions in Audio menu

DUAL-4K: PIP LEFT/RIGHT SELECTION

- Dual-4K Picture-in-Picture display can be lower-left or lower-right
- Select in DUAL menu

DUAL-4K: 4K60P APPLE PRORES SUPPORT (APOLLO)

- Record single channel of 4K60p in Apollo
- NOTE: Function already available in Odyssey7Q+/7Q Apollo Mode

QUAD-HD: DOUBLE MASTER RECORDING

- Simultaneously record identical files to both SSDs
- 1080p 23.98, 24, 25, 29.97, 30
- 1080i 50, 59.94; 720p 50, 59.94, 60

QUAD-HD: A/V ALIGN

- Individually adjust frame delay to audio and/or video of each input
- Add up to four frames delay per video track
- Add up to seven frames delay per audio track
- Note: Not available when using 3:2 Pulldown Removal

QUAD-HD: 3:2 PULLDOWN REMOVAL SUPPORT

- 24p signals embedded within 1080i60 streams recorded as 1080p24
- Intermix 3:2 Pulldown signals (24p within 60i) with 24p/24psf signals
- Note: Not available when using A/V Align

QUAD-HD: MARKERS DURING RECORD

- Set Markers while in Record
- During Record, MARKER button replaces Safe-Eject button

QUAD-HD: IMPROVED FOCUS ASSIST ACCESS

- Option to switch HIDE button to FOCUS (Focus Assist) for easier access

QUAD-HD LIVE-SWITCH: DISSOLVES

- Added dissolves (slow/medium/fast) in Live-Switch recording & output
- CUT/FADE shortcut button replaces * button during recording
- Dissolve speeds: Slow = 16 frames, Medium = 8 frames, Fast = 4 frames
- Select dissolve speed in QUAD menu

QUAD HD LIVE-SWITCH: AUDIO-FOLLOWS-VIDEO

- Live-Switch option to also switch audio source along with video source
- Affects audio source to Live-Switch recording and output
- Select in Audio menu
- Audio fade-out/fade-in transition is 21 milliseconds to smooth audio cuts

QUAD-HD LIVE-SWITCH: OLED MONITOR-ONLY SWITCHING

- Switch OLED view without affecting Live-Switch recording or output
- Select OLED view using Lower Toolbar QUAD/A/B/C/D buttons
- NOTE: Monitor-Only Switching affects SDI A & SDI B outputs unless they are set to Preview (SDI A Out) & Program (SDI B Out)

QUAD-HD LIVE-SWITCH: SINGLE-TAP/DOUBLE-TAP SWITCHING

- Switch inputs with a single tap or use double-tap Preview/Program mode
- Select between single-tap/double-tap in QUAD menu

QUAD-HD LIVE-SWITCH: EXPANDED SDI MONITOR OUTPUT OPTIONS

- SDI A Out selectable between Quad-Split view or Preview
- SDI B Out selectable between Quad-Split view or Program

SDI A Out options in Output menu:

- LUT OFF (Quad-Split view with no LUT applied)
- LUT ON (Quad-Split view with LUT applied)
- MIRROR OLED (Quad-Split view with Preview/Program and other overlays)
- LIVE-SWITCH PREVIEW (Preview input selection)

SDI B Out options in Output menu:

- LUT OFF (Quad-Split view with no LUT applied)
- LUT ON (Quad-Split view with LUT applied)
- MIRROR OLED (Quad-Split view with Preview/Program and other overlays)
- LIVE-SWITCH PROGRAM (Program input selection)

NOTES:

- When either output is set to Mirror OLED, LUT application mirrors OLED
- When SDI A Out is set to Live-Switch Preview, LUT is not applied
- When SDI B Out is set to Live-Switch Program, LUT application mirrors OLED

QUAD-HD QUAD-SPLIT: TIMECODE BURN-IN

- • Timecode window is baked into the Quad-Split recorded image

NEW FEATURES: ODYSSEY RAW BUNDLE (ODYSSEY7Q+/7Q)

ODYSSEY RAW BUNDLE GRANT

- Owners of individual RAW options granted full Odyssey RAW Bundle
- Log in at account on CD website for Activation code
- Odyssey7Q+/7Q Rental options are now Odyssey RAW Bundle and Apollo

DUAL-HD RECORDING

- Record two HD video signals simultaneously in Apple ProRes (HQ/422/LT)
- Two SSDs required (one recording per SSD)
- Matching timecode (input A, input B, Odyssey-generated or LTC)
- Resolutions & frame rates must match
- No Genlock required
- 1080p 23.98, 24, 25, 29.97, 30
- 1080i 50, 60
- 720p 50, 60

SONY FS5 RAW SUPPORT

- Record RAW in CinemaDNG from the Sony PXW-FS5
- Record RAW -> Apple ProRes from the Sony PXW-FS5
Note: Set FS5 to Picture Profile S-Log2, Color Mode S-Gamut/3200 or S-Gamut/5500
- 4K FS RAW -> 4K CinemaDNG 23.98, 25, 29.97, 50, 59.94
- 2K FS RAW -> 2K CinemaDNG 23.98, 25, 29.97, 50, 59.94, 100, 120, 200, 240
- 4K FS RAW Burst -> 4K CinemaDNG 100, 120
- 4K FS RAW -> 4K Apple ProRes 23.98, 25, 29.97, 50, 59.94
- 4K FS RAW -> UHD Apple ProRes 23.98, 25, 29.97, 50, 59.94
- 4K FS RAW -> 2K Apple ProRes 23.98, 25, 29.97, 50, 59.94
- 4K FS RAW -> HD Apple ProRes 23.98, 25, 29.97, 50, 59.94
- 2K FS RAW HS -> 2K Apple ProRes 100, 120, 200, 240
- 2K FS RAW HS -> HD Apple ProRes 100, 120, 200, 240
- 4K FS RAW Burst -> 4K/UHD Apple ProRes 100, 120
- 4K FS RAW Burst -> 2K/HD Apple ProRes 100, 120

IO 4K RAW SUPPORT

- Record RAW in CinemaDNG from the IO Industries Flare 4K
- 4K RAW -> 4K CinemaDNG 23.98, 24, 25, 29.97, 30, 47.95, 48, 50, 59.94, 60

NEW FEATURES: ALL MODELS (APOLLO, ODYSSEY7Q+/7Q/7)

8-CHANNEL AUDIO SUPPORT

- Record 8-channel SDI embedded audio in Apple ProRes (HQ/422/LT)
- Up to 32 channels in Apollo Quad-HD (8 channels per video input)
- Up to 16 channels in Apollo Dual-4K (8 channels per video input)
- Up to 8 channels in Odyssey 4K/UHD/2K/HD
- SDI embedded only, HDMI & Analog In limited to 2-Channel audio
- Audio meters display first two channels per input (first four channels per input in Apollo Dual-4K)
- Audio Out & HDMI/SDI embedded out use first two channels of video input
Note: 8-channel audio not available in RAW, RAW->Apple ProRes, DPX, or Apple ProRes 4444 modes

FOCUS ASSIST NOISE REDUCTION

- Improves legibility of Focus Assist
- Does not affect recorded signal
- NOTE: Enhance mode removed

EMBEDDED SDI RECORD TRIGGER PASS THROUGH

- Passes through SDI record trigger signal from various cameras to SDI outputs
- Regardless of trigger source, output trigger is ARRI/Canon/Sony standard

IN/OUT MARKER RANGE LIMITING

- Use In/Out Markers to limit range of playback in unit
- Starting play from an In marker will automatically stop at Out Marker
- Select LOOP in Playlist to repeatedly play only the selected In/Out range

NEW FEATURES: ODYSSEY7

OVERLAYS OUTPUT ON/OFF

- • Switch on/off OLED overlays to HDMI & SDI outputs
- • Select in Output menu

FIXES & IMPROVEMENTS

APOLLO

- • FIXED Rare file corruption issue
- • FIXED 1080p60 signal detection issue
- • FIXED Occasional audio delay on SDI & HDMI outputs
- • IMPROVED SDI B output carries embedded audio
- • IMPROVED Source Naming added to XML file

ODYSSEY RAW BUNDLE

- • FIXED Rare Canon RAW -> Apple ProRes frame issue
- • IMPROVED Sony FS RAW -> Apple ProRes 240p drive spanning enabled
- • IMPROVED Sony FS7 4K FS RAW -> 4K/UHD Apple ProRes debayer color fringing issue (yellow artifact at sharp edges)
- • IMPROVED Playback Scrubbing artifacts of RAW recordings

ODYSSEY7Q+/7Q

- • FIXED DPX support for Sony F35
- • IMPROVED DPX now supports 1080p60 over HDMI
- • IMPROVED Playback of 4K Apple ProRes
- • IMPROVED Playback scrubbing artifacts in 4K Apple ProRes
- • IMPROVED Reduced display latency in single input HD Apple ProRes

ALL DEVICES

- • FIXED Guides interaction with Hide function
- • FIXED HDMI signal detection from computer sources
- • FIXED Timecode issue with HDMI source in Time-of-Day mode
- • IMPROVED Device boot-up time
- • IMPROVED SDI/HDMI Record Trigger from Panasonic DVX200
- • IMPROVED SDI/HDMI Record Trigger from Sony FS5/F5/F55
- • IMPROVED Playback without an input connected
- • IMPROVED Increased power draw efficiency

SOFTWARE

CD APPLE PRORES TRANSFER TOOL V2.4

- • For Apollo multitrack recordings, added option to select tracks for offload
- • Fixed Windows issues
- • Windows and Mac versions available

CD LUT CONVERTER 1.3

- To prevent formatting issues, in the Project and Notes fields these characters are no longer allowed: < > ' " &
- Windows and Mac versions available

Firmware Version 2016.01

NEW FEATURES APOLLO & ODYSSEY7Q+/7Q WITH APOLLO OPTION

DUAL-4K

- Monitor & Record two 4K/UHD video signals
- Supports 4K/UHD 23.98p, 24p, 25p, 29.97p, 30p
- Record in Apple ProRes (HQ/422/LT)
- Resolution & framerate must match
- 4K/UHD video only, no RAW conversion

Input Combinations (Apollo & Odyssey7Q+):

- HDMI + 3G-SDI Dual-Link (use SDI C & D inputs)
- HDMI + 6G-SDI (SDI B input)
- 3G-SDI Dual-Link (SDI A & B inputs) + 3G-SDI Dual-Link (SDI C & D inputs)
- 6G-SDI (SDI A input) + 3G-SDI Dual-Link (SDI C & D input)
- 6G-SDI (SDI A input) + 6G-SDI (SDI B input)

Input Combinations (Odyssey7Q):

- 3G-SDI Dual-Link (SDI A & B inputs) + 3G-SDI Dual-Link (SDI C & D inputs)

QUAD-HD 1080P 50/60 SUPPORT

- Monitor & Record up to four 1080p 50p, 59.97p, 60p video signals
- No recording of Quad-Split or Live-Switch when inputs are 1080p 50/59.94/60
- Both 3G level A and 3G level B supported

Input Combinations (Apollo & Odyssey7Q+):

- HDMI + 3x 3G-SDI
- 4x 3G-SDI

Input Combinations (Odyssey7Q):

- 4x 3G-SDI

4K 50/60P SUPPORT

- Monitor & Record 4K/UHD 23.98p, 24p, 25p, 29.97p, 30p, 50p, 59.94p, 60p
- Record in Apple ProRes (HQ/422/LT)
- 4x 3G-SDI required for 4K/UHD 50p, 59.94p, 60p
- Dual-4K not supported at 50p, 59.94p, 60p

Supporting Sony F55 & IO Industries 4KSDI

- Set F55 to "2SI" output for 4K/UHD 50p, 59.94p, 60p
- Set IO 4KSDI to Quad-Link interleaved output for 4K/UHD 50p, 59.94p, 60p

ADDITIONAL APOLLO FUNCTIONS

- Lower Toolbar full screen switching in Quad-Split or A/B/C/D recording modes
- Improved Monitoring Tool usage when not recording
- Program-Preview single-tap switching in Live-Switch mode (upon selection of new Program source, previous selection automatically becomes Preview)
- Input labeling (display as overlay on OLED and/or outputs)

NEW FEATURES APOLLO / ODYSSEY7Q+ (APOLLO OPTION NOT REQUIRED)

6G SDI SUPPORT FOR BLACKMAGIC DESIGN CAMERAS

- Monitor & Record 4K/UHD 23.98p, 24p, 25p, 29.97p, 30p
- Record in Apple ProRes (HQ/422/LT)

Notes:

- 6G-SDI 75 Ohm cables required
- In Odyssey "4K ProRes 422" mode, only SDI A IN is 6G active

NEW FEATURES ODYSSEY7Q+/ODYSSEY7Q (APOLLO OPTION NOT REQUIRED)

4K 50/60P SUPPORT

- Monitor & Record 4K/UHD 23.98p, 24p, 25p, 29.97p, 30p, 50p, 59.94p, 60p
- Record in Apple ProRes (HQ/422/LT)
- 4x 3G-SDI required for 4K/UHD 50p, 59.94p, 60p

Supporting Sony F55, Panasonic VariCam35 & IO Industries 4KSDI

- Set F55 & VariCam35 to "2SI" output for 4K/UHD 50p, 59.94p, 60p
- Set IO 4KSDI to Quad-Link interleaved output for 4K/UHD 50p, 59.94p, 60p



QUAD-HD MONITORING

- Monitor only mode

FIXES & IMPROVEMENTS

- FIXED Rare Canon C500/C300 Mk II RAW->Apple ProRes frame issue
- FIXED Rare file corruption issue with Apollo recordings
- FIXED DPX Sony F35 Support
- FIXED SDI/HDMI Record Trigger from the Panasonic DVX200
- FIXED Apollo Option SDI B Out now carries audio
- FIXED HDMI source Time-of-Day timecode
- IMPROVED Playback without a connected source (all record modes)
- IMPROVED Camera Angle info added to metadata
- IMPROVED Playback Scrubbing artifacts in 4K
- IMPROVED Playback Scrubbing artifacts in all RAW modes
- IMPROVED Power saving for inactive ports

SOFTWARE

CD APPLE PRORES TRANSFER TOOL V2.2

- Improved Support for Apollo Apple ProRes files
- ADDED Camera Angle metadata
- FIXED Timecode Issue with Spanned Apollo Files
- Other minor fixes and updates
- Windows and Mac versions available

KNOWN ISSUES 2016.01.1335 RELEASE

- Record spanning from SSD 2 back to SSD 1 is no longer supported.
- 1.5G-SDI Quad-Link for 4K/UHD up to 30p is no longer supported (use 3G-SDI Dual-Link). 3G-SDI Quad-Link for 4K/UHD up to 60p is supported.
- Files recorded with previous firmware builds not compatible with 2016.01.
- During firmware update the OLED display may go black. To correct, connect a video signal to SDI A IN.
- When playing back short 50/60p files if "Skip Frames" is not set, static audio can occur. Recorded files are unaffected.
- In rare cases when switching frame rates on the FS700, a false camera trigger may occur, resulting in a 1 second file.
- When recording Sony FS 4K RAW-> 4K/UHD Apple ProRes at 50/59.94p, using Pixel Zoom will shift the image on OLED. Recorded files are unaffected.
- Canon RAW playback may be jumpy. To correct, select a point within the clip and press PLAY. If this does not correct issue, deselect clip then reselect.
- In Apollo mode, when using LTC In timecode source, cameras must be genlocked to prevent timecode drift.
- In Apollo mode, when using Pixel Zoom, on-screen camera angle labels may not be correctly aligned.
- In Apollo mode, Anamorphic Desqueeze is not available.
- Apollo Dual-4K does not support loss of source. If either video signal is lost the recording will stop.

Earlier Versions

Please see our website for release notes for earlier firmware versions.

Limited Warranty

Convergent Design warrants Odyssey, and all included accessories, against defects in material and workmanship for a period of one year for registered units, and 3 months (for units used as rentals) from the original date of purchase.

Convergent Design disclaims all other warranties.

Convergent Design will not be liable for damages of any kind, including, but not limited to, compensation or reimbursement on account of failure of the unit, or any of its accessories, or its recording media, external storage systems, or any other media or storage systems to record or playback content of any type. Also Convergent Design will not be liable for a failure of the unit to properly record or play back for any reason. Convergent Design's total liability, in all cases, is limited to the actual purchase price.

If you discover a defect, please refer to our Return Merchandise Policy below.

During the warranty period, Convergent Design, at its option, will repair or replace product or product components, which in its opinion prove defective, provided the unit is returned, freight charges prepaid, to Convergent Design. Parts and components used in the repair process may be recycled or repaired, at Convergent Design's sole discretion. This warranty service will be performed at no charge to the registered owner, provided the product is shipped prepaid to Convergent Design.

Convergent Design reserves the right to determine whether a needed repair is subject to the warranty as per its provisions stated herein. Transit damage caused by inadequate packing violates the warranty. The warranty will be void if, in the opinion of Convergent Design, the product has been damaged through accident, misuse, misapplication, or as a result of service or modification not authorized in writing by Convergent Design.

Opening the unit and breaking the warranty seals, voids the warranty, unless specifically authorized in advance by Convergent Design.

THE FOLLOWING ARE NOT COVERED UNDER WARRANTY, AND ARE ITEMS FOR WHICH CONVERGENT DESIGN DOES NOT ACCEPT ANY RESPONSIBILITY:

Damage due to the use of an AC power supply, other than the one supplied, or use of any inappropriate power source.

Damage due to overheating conditions. The unit will attempt to shut down, if powered on, in the event of overheating, before damage can occur.

Damage due to exposure to water, or other liquids, or excessive dust or sand.

Damage caused by dropping or other rough handling.

Damage caused by any over-voltage conditions or reverse voltage conditions.

Any physical damage to the OLED and/or Touch Screen including scratches.

Damage to any connector by using excessive force or rough handling.

Any loss or corruption of video or audio data recorded on the unit, or any loss or corruption of data that is in any way associated with the Odyssey.

Monitor/Record Options

SONY FS7/FS700	HD/2K 4:2:2 -> HD/2K ProRes (.MOV) FS 4K RAW -> HD ProRes (.MOV) FS 4K RAW -> 2K ProRes (.MOV) FS 4K RAW -> 4K ProRes (.MOV) FS 4K RAW -> UHD ProRes (.MOV) FS 4K/2K RAW -> RAW (.DNG) HD/2K 4:2:2/4:4:4 -> 4:4:4 (.DPX)
SONY	4K/UHD 4:2:2-> 4K/UHD ProRes (.MOV) HD/2K 4:2:2 -> HD/2K ProRes (.MOV) HD/2K 4:2:2/4:4:4 -> 4:4:4 (.DPX)
CANON	CANON C500 4K/QHD RAW -> RAW (.RMF) CANON C500 4K/QHD RAW -> 4K/UHD ProRes (.MOV) HD/2K 4:2:2 -> HD/2K ProRes (.MOV) HD/2K 4:2:2/4:4:4 -> 4:4:4 (.DPX)
ARRI	ALEXA ARRIRAW -> ARRIRAW (.ARI) HD/2K 4:2:2 -> HD/2K ProRes (.MOV) HD/2K 4:2:2/4:4:4 -> 4:4:4 (.DPX)
POV RAW	INDIECAM RAW -> RAW (.DNG) IO INDUSTRIES 2K/HD RAW -> RAW (.DNG)
OTHER	4K/UHD 4:2:2-> 4K/UHD ProRes (.MOV) HD/2K 4:2:2 -> HD/2K ProRes (.MOV) HD/2K 4:2:2/4:4:4 -> 4:4:4 (.DPX)
PANASONIC	4K/UHD 4:2:2-> 4K/UHD ProRes (.MOV) HD/2K 4:2:2 -> HD/2K ProRes (.MOV) HD/2K 4:2:2/4:4:4 -> 4:4:4 (.DPX)
RED	4K/UHD 4:2:2-> 4K/UHD ProRes (.MOV) HD/2K 4:2:2 -> HD/2K ProRes (.MOV) HD/2K 4:2:2/4:4:4 -> 4:4:4 (.DPX)
MULTI-STREAM (Apollo Option)	4x HD signals -> 4x HD ProRes (.MOV) - Plus HD Multiplex or HD Live-Switch 2x 4K/UHD -> 2x 4K/UHD ProRes (.MOV)

Online Resources

Home Page	http://convergent-design.com
New Account	https://convergent-design.com/register.html
Activate Device	https://convergent-design.com/account.html
Products	https://convergent-design.com/products
Apollo	https://convergent-design.com/apollo
Odyssey7Q+	https://convergent-design.com/plus
Apollo Option	https://convergent-design.com/odyssey-upgrades/apollo-option
Odyssey RAW Bundle	https://convergent-design.com/odyssey-upgrades/raw-recording
Accessories	https://convergent-design.com/accessories
Account Dashboard	https://convergent-design.com/account
My Devices	https://convergent-design.com/account#my-devices
My Orders	https://convergent-design.com/my-orders
Update Profile	https://convergent-design.com/update-profile.html
Subscriptions	https://convergent-design.com/subscriptions
Support	https://convergent-design.com/support.html
Firmware/Downloads	https://convergent-design.com/firmware-downloads
Knowledgebase	https://convergent-design.com/kb
Support Tickets	https://convergent-design.com/support-tickets
Videos	https://convergent-design.com/videos
Company	https://convergent-design.com/company
Blog/News	https://convergent-design.com/blog
Contact Us	https://convergent-design.com/contact-us
Press/Media	https://convergent-design.com/media-resources
Where to Buy	https://convergent-design.com/where-to-buy
Dealer Inquiry	https://convergent-design.com/dealer-inquiry.html

Looking for something you don't see here? Try out the Search box on any page of our website.

© 2016 Convergent Design, Inc. - All Rights Reserved.

All copyrights and trademarks remain the property of their respective owners.

Updated June 10, 2016 1:26 PM



Fin