

LCD Monitor

Operating Instructions

Before operating the unit, please read this manual thoroughly and retain it for future reference.

LMD-2110W

HDMI™
HIGH-DEFINITION MULTIMEDIA INTERFACE

Owner's Record

The model and serial numbers are located at the rear. Record these numbers in the spaces provided below. Refer to these numbers whenever you call upon your Sony dealer regarding this product.

Model No. _____

Serial No. _____

Important Safety Instructions

- Read these instructions.
- Keep these instructions.
- Heed all warnings.
- Follow all instructions.
- Do not use this apparatus near water.
- Clean only with dry cloth.
- Do not block any ventilation openings. Install in accordance with the manufacturer's instructions.
- Do not install near any heat sources such as radiators, heat registers, stoves, or other apparatus (including amplifiers) that produce heat.
- Do not defeat the safety purpose of the polarized or grounding-type plug. A polarized plug has two blades with one wider than the other. A grounding-type plug has two blades and a third grounding prong. The wide blade or the third prong are provided for your safety. If the provided plug does not fit into your outlet, consult an electrician for replacement of the obsolete outlet.
- Protect the power cord from being walked on or pinched particularly at plugs, convenience receptacles, and the point where they exit from the apparatus.
- Only use attachments/accessories specified by the manufacturer.
- Use only with the cart, stand, tripod, bracket, or table specified by the manufacturer, or sold with the apparatus.  When a cart is used, use caution when moving the cart/apparatus combination to avoid injury from tip-over.
- Unplug this apparatus during lightning storms or when unused for long periods of time.
- Refer all servicing to qualified service personnel. Servicing is required when the apparatus has been damaged in any way, such as power-supply cord or plug is damaged, liquid has been spilled or objects have fallen into the apparatus, the apparatus has been exposed to rain or moisture, does not operate normally, or has been dropped.

WARNING

To reduce the risk of fire or electric shock, do not expose this apparatus to rain or moisture.

To avoid electrical shock, do not open the cabinet. Refer servicing to qualified personnel only.

WARNING

THIS APPARATUS MUST BE EARTHED.

WARNING

When installing the unit, incorporate a readily accessible disconnect device in the fixed wiring, or connect the power plug to an easily accessible socket-outlet near the unit. If a fault should occur during operation of the unit, operate the disconnect device to switch the power supply off, or disconnect the power plug.

CAUTION

The apparatus shall not be exposed to dripping or splashing. No objects filled with liquids, such as vases, shall be placed on the apparatus.

Do not install the appliance in a confined space, such as book case or built-in cabinet.

CAUTION

The unit is not disconnected from the AC power source (mains) as long as it is connected to the wall outlet, even if the unit itself has been turned off.

WARNING

Make sure the surface is wide enough so that this apparatus's width and depth don't exceed the surface's edges. If not, this apparatus may lean or fall over and cause an injury.

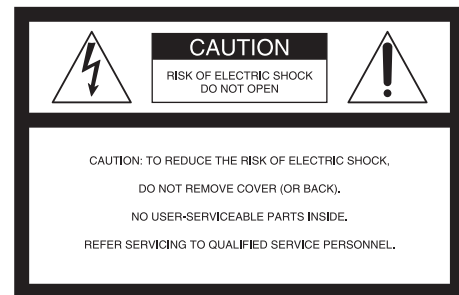

This symbol is intended to alert the user to the presence of uninsulated "dangerous voltage" within the product's enclosure that may be of sufficient magnitude to constitute a risk of electric shock to persons.



This symbol is intended to alert the user to the presence of important operating and maintenance (servicing) instructions in the literature accompanying the appliance.

Attention-when the product is installed in Rack:

1. Prevention against overloading of branch circuit

When this product is installed in a rack and is supplied power from an outlet on the rack, please make sure that the rack does not overload the supply circuit.

2. Providing protective earth

When this product is installed in a rack and is supplied power from an outlet on the rack, please confirm that the outlet is provided with a suitable protective earth connection.

3. Internal air ambient temperature of the rack

When this product is installed in a rack, please make sure that the internal air ambient temperature of the rack is within the specified limit of this product.

4. Prevention against achieving hazardous condition due to uneven mechanical loading

When this product is installed in a rack, please make sure that the rack does not achieve hazardous condition due to uneven mechanical loading.

5. Install the equipment while taking the operating temperature of the equipment into consideration

For the operating temperature of the equipment, refer to the specifications of the Operation Manual.

6. When performing the installation, keep the following space away from walls in order to obtain proper exhaust and radiation of heat.

Lower, Upper: 4.4 cm (1 3/4 inches) or more

For kundene i Norge

Dette utstyret kan kobles til et IT-strømfordelingssystem.

Apparatet må tilkoples jordet stikkontakt

Suomessa asuville asiakkaille

Laite on liitettävä suojamaadoituskaskettimilla varustettuun pistorasiaan

För kunderna i Sverige

Apparaten skall anslutas till jordat uttag

For the customers in the U.S.A.

This equipment has been tested and found to comply with the limits for a Class A digital device, pursuant to Part 15 of the FCC Rules. These limits are designed to provide reasonable protection against harmful interference when the equipment is operated in a commercial environment. This equipment generates, uses, and can radiate radio frequency energy and, if not installed and used in accordance with the instruction manual, may cause harmful interference to radio

communications. Operation of this equipment in a residential area is likely to cause harmful interference in which case the user will be required to correct the interference at his own expense.

You are cautioned that any changes or modifications not expressly approved in this manual could void your authority to operate this equipment.

All interface cables used to connect peripherals must be shielded in order to comply with the limits for a digital device pursuant to Subpart B of Part 15 of FCC Rules.

This device complies with Part 15 of the FCC Rules. Operation is subject to the following two conditions: (1) this device may not cause harmful interference, and (2) this device must accept any interference received, including interference that may cause undesired operation.

WARNING

Using this unit at a voltage other than 120 V may require the use of a different line cord or attachment plug, or both. To reduce the risk of fire or electric shock, refer servicing to qualified service personnel.

For the customers in Canada

This Class A digital apparatus complies with Canadian ICES-003.

For the customers in Europe

This product with the CE marking complies with the EMC Directive issued by the Commission of the European Community.

Compliance with this directive implies conformity to the following European standards:

- EN55103-1 : Electromagnetic Interference (Emission)
- EN55103-2 : Electromagnetic Susceptibility (Immunity)

This product is intended for use in the following Electromagnetic Environments: E1 (residential), E2 (commercial and light industrial), E3 (urban outdoors), E4 (controlled EMC environment, ex. TV studio).

For the customers in Europe

This product has been manufactured by or on behalf of Sony Corporation, 1-7-1 Konan Minato-ku Tokyo, 108-0075 Japan. Inquiries related to product compliance based on European Union legislation shall be addressed to the authorized representative, Sony Deutschland GmbH, Hedelfinger Strasse 61, 70327 Stuttgart, Germany. For any service or guarantee matters, please refer to the addresses provided in the separate service or guarantee documents.

Table of Contents

| | |
|---|-----------|
| Precaution | 5 |
| On Safety | 5 |
| On Installation | 5 |
| Handling the LCD Screen | 5 |
| On Burn-in | 5 |
| On a Long Period of Use | 5 |
| On Cleaning | 6 |
| On Moisture Condensation | 6 |
| On Repacking | 6 |
| On Mounting on a Rack | 6 |
| Disposal of the Unit | 6 |
| On Fan Error | 6 |
| Features | 7 |
| Location and Function of Parts and Controls | 8 |
| Front Panel | 8 |
| Input Signals and Adjustable/Setting Items | 9 |
| Rear Panel | 10 |
| Installing to the Rack | 11 |
| Connecting the AC Power Cord | 12 |
| Attaching the Input Adaptor | 12 |
| Selecting the Default Settings | 13 |
| Selecting the Menu Language | 14 |
| Using the Menu | 15 |
| Adjustment Using the Menus | 16 |
| Items | 16 |
| Adjusting and Changing the Settings | 17 |
| STATUS menu..... | 17 |
| COLOR TEMP/BAL menu | 17 |
| USER CONTROL menu..... | 18 |
| USER CONFIG menu..... | 18 |
| REMOTE menu | 20 |
| KEY INHIBIT menu..... | 21 |
| Troubleshooting | 21 |
| Specifications | 22 |
| Dimensions | 25 |

Precaution

On Safety

- Operate the unit only with a power source as specified in the “Specifications” section.
- A nameplate indicating operating voltage, etc., is located on the rear panel.
- Should any solid object or liquid fall into the cabinet, unplug the unit and have it checked by qualified personnel before operating it any further.
- Do not drop or place heavy objects on the power cord. If the power cord is damaged, turn off the power immediately. It is dangerous to use the unit with a damaged power cord.
- Unplug the unit from the wall outlet if it is not to be used for several days or more.
- Disconnect the power cord from the AC outlet by grasping the plug, not by pulling the cord.
- The socket-outlet shall be installed near the equipment and shall be easily accessible.

On Installation

- Allow adequate air circulation to prevent internal heat build-up.
Do not place the unit on surfaces (rugs, blankets, etc.) or near materials (curtains, draperies) that may block the ventilation holes.
- Do not install the unit in a location near heat sources such as radiators or air ducts, or in a place subject to direct sunlight, excessive dust, mechanical vibration or shock.

Handling the LCD Screen

- The LCD panel fitted to this unit is manufactured with high precision technology, giving a functioning pixel ratio of at least 99.99%. Thus a very small proportion of pixels may be “stuck”, either always off (black), always on (red, green, or blue), or flashing. In addition, over a long period of use, because of the physical characteristics of the liquid crystal display, such “stuck” pixels may appear spontaneously. These problems are not a malfunction.
- Do not leave the LCD screen facing the sun as it can damage the LCD screen. Take care when you place the unit by a window.
- Do not push or scratch the LCD screen. Do not place a heavy object on the LCD screen. This may cause the screen to lose uniformity.

- If the unit is used in a cold place, horizontal lines or a residual image may appear on the screen. This is not a malfunction. When the monitor becomes warm, the screen returns to normal.
- The screen and the cabinet become warm during operation. This is not a malfunction.

On Burn-in

For LCD panel, permanent burn-in may occur if still images are displayed in the same position on the screen continuously, or repeatedly over extended periods.

Images that may cause burn-in

- Masked images with aspect ratios other than 16:9
- Color bars or images that remain static for a long time
- Character or message displays that indicate settings or the operating state

To reduce the risk of burn-in

- Turn off the character displays
Press the MENU button to turn off the character displays. To turn off the character displays of the connected equipment, operate the connected equipment accordingly. For details, refer to the operation manual of the connected equipment.
- Turn off the power when not in use
Turn off the power if the monitor is not to be used for a prolonged period of time.

On a Long Period of Use

Due to the characteristics of LCD panel, displaying static images for extended periods, or using the unit repeatedly in a high temperature/high humidity environments may cause image smearing, burn-in, areas of which brightness is permanently changed, lines, or a decrease in overall brightness.

In particular, continued display of an image smaller than the monitor screen, such as in a different aspect ratio, may shorten the life of the unit.

Avoid displaying a still image for an extended period, or using the unit repeatedly in a high temperature/high humidity environment such an airtight room, or around the outlet of an air conditioner.

To prevent any of the above issues, we recommend reducing brightness slightly, and to turn off the power whenever the unit is not in use.

On Cleaning

Before cleaning

Be sure to disconnect the AC power cord from the AC outlet.

On cleaning the monitor screen

The monitor screen surface is especially treated to reduce reflection of light.

As incorrect maintenance may impair the performance of the monitor, take care with respect to the following:

- Wipe the screen gently with a soft cloth such as a cleaning cloth or glass cleaning cloth.
- Stubborn stains may be removed with a soft cloth such as a cleaning cloth or glass cleaning cloth lightly dampened with water.
- Never use solvent such as alcohol, benzene or thinner, or acid, alkaline or abrasive detergent, or chemical cleaning cloth, as they will damage the screen surface.

On cleaning the cabinet

- Clean the cabinet gently with a soft dry cloth. Stubborn stains may be removed with a cloth lightly dampened with mild detergent solution, followed by wiping with a soft dry cloth.
- Use of alcohol, benzene, thinner or insecticide may damage the finish of the cabinet or remove the indications on the cabinet. Do not use these chemicals.
- If you rub on the cabinet with a stained cloth, the cabinet may be scratched.
- If the cabinet is in contact with a rubber or vinyl resin product for a long period of time, the finish of the cabinet may deteriorate or the coating may come off.

On Moisture Condensation

If the unit is brought directly from a cold place to a warm place, or the unit is warm and the ambient temperature cools suddenly (by air-conditioning, for example), moisture may condense on the surface or inside of the unit, or create a mist residue inside the protection plate if it is installed to the unit.

This is called moisture condensation, and is not a malfunction of the product itself, although it may cause damage to the unit.

Leave the unit in a condensation free area.

If moisture condensation has occurred, turn off the unit and do not use it until moisture condensation has evaporated.

On Repacking

Do not throw away the carton and packing materials. They make an ideal container which to transport the unit.

On Mounting on a Rack

Leave 1U space empty above and below the monitor to ensure adequate air circulation or install a fan to maintain the monitor's performance.

If you have any questions about this unit, contact your authorized Sony dealer.

Disposal of the Unit

Do not dispose of the unit with general waste.

Do not include the monitor with household waste.

When you dispose of the monitor, you must obey the law in the relative area or country.

On Fan Error

The fan for cooling the unit is built in. When the fan stops and the KEY INHIBIT indicator on the front panel blinks for fan error indication, turn off the power and contact an authorized Sony dealer.

Features

The LMD-2110W (21.5-type) is a multiple format LCD monitor for broadcast/professional use featuring a precise image and high performance. Supporting digital/analog main broadcast signals, and HDMI¹⁾ input, it can be used under various lighting conditions.

¹⁾ The terms HDMI and HDMI High-Definition Multimedia Interface, and the HDMI Logo are trademarks or registered trademarks of HDMI Licensing LLC in the United States and other countries.

High brightness LCD panel

Because of precise image and high speed response, real color image can be reproduced.

Multi-format

The monitor supports the video, Y/C, RGB, component and HDMI input signals.

Both NTSC and PAL color systems are supported, and the appropriate color system is selected automatically. SDI signals can be available when input adaptor BKM-320D (optional) is used.

HD/SD-SDI signals can be available when input adaptor BKM-341HS (optional) is used.

For more information, see “Video signal formats” (page 24).

External sync input

When the EXT SYNC button is in the on position, the unit can be operated on the sync signal supplied from an external sync generator.

Automatic termination (connector with mark only)

The input connector is terminated internally at 75 ohms when nothing has been connected to the output connector. If a cable is connected to the output connector, the internal terminal is automatically released and the signals input to the input connector are output to the output connector (loop-through).

External remote control function

You can directly select the input signal, aspect, etc., by operating the equipment connected to the PARALLEL REMOTE connector.

Monitor stand with tilt function

A monitor stand with tilt function is equipped for desk top use. It shall be removed when mounted on the rack.

Rack mount

The monitor supports the VESA (100 × 100 mm) standard.

It can be mounted on an EIA standard 19-inch rack (using an optional mounting bracket).

For more information, see “Installing to the Rack” (page 11).

Consult with Sony qualified personnel for wall mount installation.

3-color tally lamp

The tally lamp lights in red, green or amber to monitor each input picture and check the on-air mode.

Blue only mode

In the blue only mode, a monochrome display is obtained with all three of the R/G/B picture elements driven with a blue signal. This mode is convenient for chroma and phase adjustments and monitoring of signal noise.

Marker function

SAFETY AREA marker, CENTER MARKER, 16:9 MARKER for the 4:3 aspect ratio or 4:3 MARKER for the 16:9 aspect ratio can be displayed.

Scan setting

You can set the display size to normal scan, over scan or full screen mode.

Select color temperature and gamma mode

You can select the color temperature from among two (HIGH and LOW) settings.

You can select the gamma mode from among five settings.

Aspect setting

You can set the monitor to 4:3 or 16:9 display mode according to the input video signal.

On-screen menus

You can set the appropriate settings according to the connected system by using the on-screen menus.

Select language display

You can select from seven display languages, English, French, German, Spanish, Italian, Japanese and Chinese.

Key inhibit function

You can inhibit a key function to prevent missing an operation.

I/P mode setting

This unit is equipped with an I/P mode setting function that is used to minimize picture delay due to the signal conversion process.

Location and Function of Parts and Controls

Front Panel

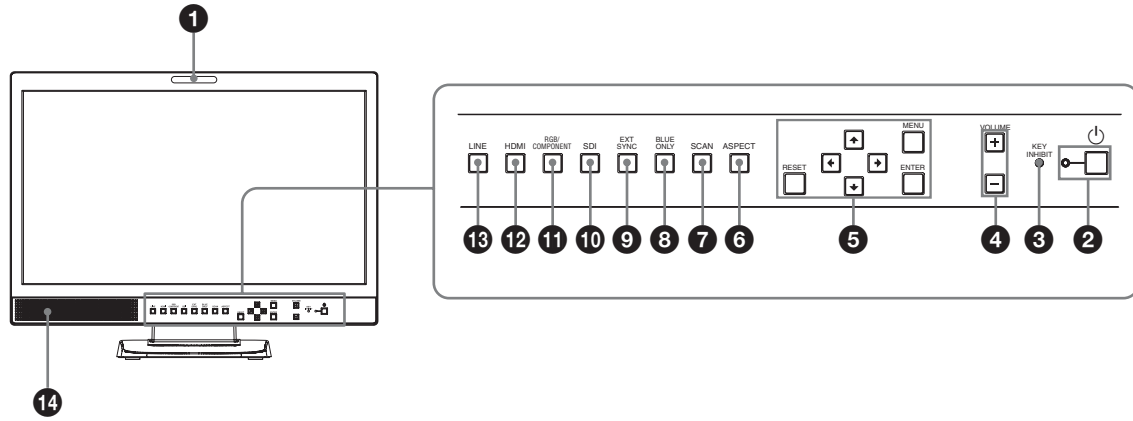

1 Tally lamp

You can check the status of the monitor by the color of the tally lamp.

The tally lamp lights in red, green or amber according to the setting of the REMOTE menu.

2 (standby) switch and indicator

Press to turn on the power when this unit is in standby mode. The indicator turns on. Press again to set the monitor in standby mode. The indicator goes out.

3 KEY INHIBIT indicator

Lights when the key inhibit function works. The indicator blinks when fan error occurs.

For details on the key inhibit, see “KEY INHIBIT menu” (page 21).

4 VOLUME buttons

Press the + button to increase the volume or the – button to decrease it.

5 Menu operation buttons

Displays or sets the on-screen menu.

↑/↓/←/→ (arrow) buttons

Select the menu or make various adjustments.

MENU button

Press to display the on-screen menu. Press again to clear the menu.

RESET button

Resets the value of an item back to the previous value. This button functions when the menu item is adjusted (displayed) on the screen.

ENTER button

Press to confirm a selected item on the menu.

6 ASPECT select button

Sets the aspect ratio of the picture, 4:3 or 16:9.

7 SCAN select button

You can change the scan size of the picture. Press to change the scan size among over (5% over scan), normal (0% scan) and full screen set on the SCAN menu (page 19).

8 BLUE ONLY button

Press to eliminate the red and green signals. Only blue signal is displayed as a monochrome picture on the screen. This mode is convenient for chroma and phase adjustments and monitoring of signal noise.

9 EXT SYNC (external sync) button

Press to operate the unit on an external sync signal through the EXT SYNC IN connector. The EXT SYNC button works when the component/RGB signals are input.

10 SDI button

Press to monitor the signal through the OPTION IN connector.

11 RGB/COMPONENT button

Press to monitor the signal through the RGB/COMPONENT input connector.

12 HDMI button

Press to monitor the signal through the HDMI IN connector.

13 LINE button

Press to monitor the signal through the LINE input connector.

14 Speaker

The audio signal selected by the input select button (10 SDI button, 11 RGB/COMPONENT button, 12 HDMI button or 13 LINE button) on the front panel is output.

Input Signals and Adjustable/Setting Items

| Item | Input signal | | | | | | | | | |
|-----------------------------------|--------------|----------------|----------------|-----|-----|-----|-------|------|-----|-------|
| | Video, Y/C | B & W | Component | | RGB | | SDI*4 | HDMI | | |
| | | | SD | HD | SD | HD | SD/HD | SD | HD | DVI*5 |
| CONTRAST | ○ | ○ | ○ | ○ | ○ | ○ | ○ | ○ | ○ | ○ |
| BRIGHT | ○ | ○ | ○ | ○ | ○ | ○ | ○ | ○ | ○ | ○ |
| CHROMA | ○ | × | ○ | ○ | × | × | ○ | ○ | ○ | × |
| PHASE | ○ (NTSC) | × | × | × | × | × | × | × | × | × |
| APERTURE | ○ | ○ | ○ | ○ | ○ | ○ | ○ | ○ | ○ | × |
| COLOR TEMP | ○ | ○ | ○ | ○ | ○ | ○ | ○ | ○ | ○ | ○ |
| COMPONENT LEVEL*1 | × | × | ○ (480/60I) | × | × | × | × | × | × | × |
| NTSC SETUP | ○ (NTSC) | ○ (480/60I) | × | × | × | × | × | × | × | × |
| GAMMA | ○ | ○ | ○ | ○ | ○ | ○ | ○ | ○ | ○ | ○ |
| SCAN | ○ | ○ | ○ | ○ | ○ | ○ | ○ | ○ | ○ | × |
| ASPECT | ○ | ○ | ○ | ○*2 | ○ | ○*2 | ○ | ○ | ○*2 | × |
| MARKER | ○ | ○ | ○ | ○ | ○ | ○ | ○ | ○ | ○ | × |
| BLUE ONLY | ○ | × | ○ | ○ | ○ | ○ | ○ | ○ | ○ | × |
| I/P MODE*3 | ○ | ○ | ○ | ○ | ○ | ○ | ○ | ○ | ○ | × |
| EXT SYNC | × | × | ○ | ○ | ○ | ○ | × | × | × | × |
| SD PIXEL MAPPING COMPOSITE&Y/C | ○ | ○ | × | × | × | × | × | × | × | × |
| SD PIXEL MAPPING RGB/COMPONENT | × | × | ○ | × | ○ | × | × | × | × | × |

○ : Adjustable/can be set
 × : Not adjustable/cannot be set

- *1 When a component signal (480/60I) is input, this can be switchable.
- *2 When a 480/60P or 576/50P signal is input, this can be switchable.
- *3 When an interlace signal is input, this can be switchable.
- *4 When BKM-320D or BKM-341HS is used, SDI signals can be input.
- *5 When a PC signal is input to the HDMI IN connector using a DVI conversion cable, this can be adjusted.

Rear Panel

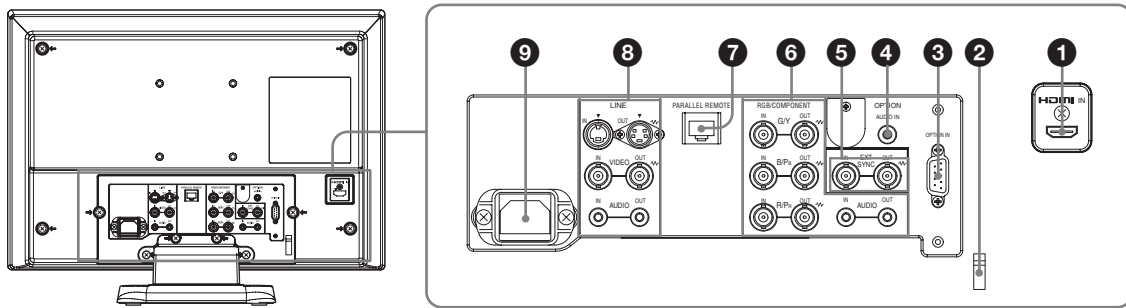

1 HDMI IN connector

HDMI (High-Definition Multimedia Interface) is an interface that supports both video and audio on a single digital connection, allowing you to enjoy high quality digital picture and sound. The HDMI specification supports HDCP (High-bandwidth Digital Content Protection), a copy protection technology that incorporates coding technology for digital video signals.

Notes

- Use HDMI compliant cable (optional) with HDMI logo.
- Color noise may appear on the edge of the screen depending on the connected device. This is not a malfunction.

2 HDMI cable holder

Secures the HDMI cable (Ø7 mm or less).

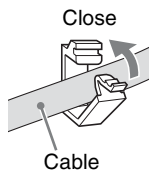

3 OPTION IN connector (D-sub 9-pin, female)

Inputs SD-SDI signals when optional Sony BKM-320D is connected. Inputs HD/SD-SDI signals when optional Sony BKM-341HS is connected. Press the SDI button to select the signal.

Note

Do not connect the equipment other than BKM-320D or BKM-341HS. It causes damage to the unit or the equipment.

4 OPTION AUDIO IN connector (phono jack)

Inputs an audio signal if the BKM-320D or BKM-341HS is connected to the OPTION IN connector. Press the SDI button to monitor the audio signal.

5 EXT SYNC IN/OUT (external sync) connectors (BNC)

Press the EXT SYNC button to use the sync signal through this connector.

IN connector

When this unit operates on an external sync signal, connect the reference signal from a sync generator to this connector.

Note

When inputting a video signal with the jitters, etc. the picture may be disturbed. We recommend using the TBC (time base corrector).

OUT connector

Loop-through output of the IN connector. Connect to the external sync input of video equipment to be synchronized with this unit.

When the cable is connected to this connector, the 75-ohms termination of the input is automatically released, and the signal input to the IN connector is output from this connector.

6 RGB/COMPONENT connectors

Analog RGB signal or component (Y/P_B/P_R) signal input connectors and their loop-through output connectors.

Press the RGB/COMPONENT button to monitor the signal input through these connectors.

G/Y, B/P_B, R/P_R IN/OUT (BNC)

These are the input/output connectors for an analog RGB and a component (Y/P_B/P_R) signal. Unless an external sync signal is input, the monitor is synchronized with the sync signal contained in the G/Y signal.

AUDIO IN/OUT (phono jack)

When using an analog RGB or a component signal as a video signal, use these jacks for the input/output of an audio signal. Connect them to the

audio input/output jacks on equipment such as a VCR.

7 PARALLEL REMOTE connector (modular connector, 8-pin)

Forms a parallel switch and controls the monitor externally.

For details on the pin assignment and factory setting function assigned to each pin, see page 23.

CAUTION

For safety, do not connect the connector for peripheral device wiring that might have excessive voltage to this port. Follow the instructions for this port.

8 LINE connectors

Line input connectors for Y/C separate, composite video and audio signals and their loop-through output connectors.

Press the LINE button to monitor the signal input through these connectors.

If you input signals to both Y/C IN and VIDEO IN, the signal input to the Y/C IN is selected.

Y/C IN/OUT (4-pin mini-DIN)

These are the input/output connectors for a Y/C separate signal. Connect them to the Y/C separate input/output connectors on equipment such as a VCR, video camera, or another monitor.

VIDEO IN/OUT (BNC)

These are the input/output connectors for a composite video signal. Connect them to the composite video input/output connectors on equipment such as a VCR, video camera, or another monitor.

AUDIO IN/OUT (phono jack)

These are the input/output jacks for an audio signal. Connect them to the audio input/output jacks on equipment such as a VCR.

9 AC IN socket

Connect the supplied AC power cord.

Installing to the Rack

- 1** Remove the screws (4) to remove the stand.

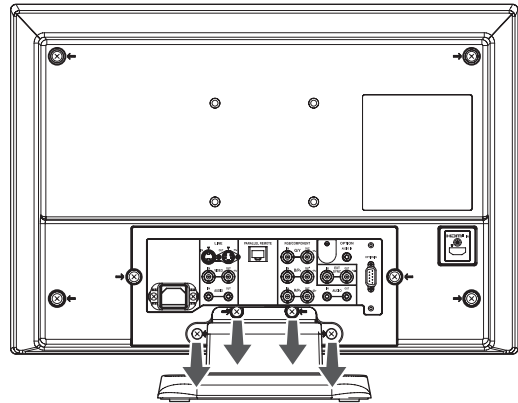

- 2** Attach the unit to the rack using the mounting bracket.

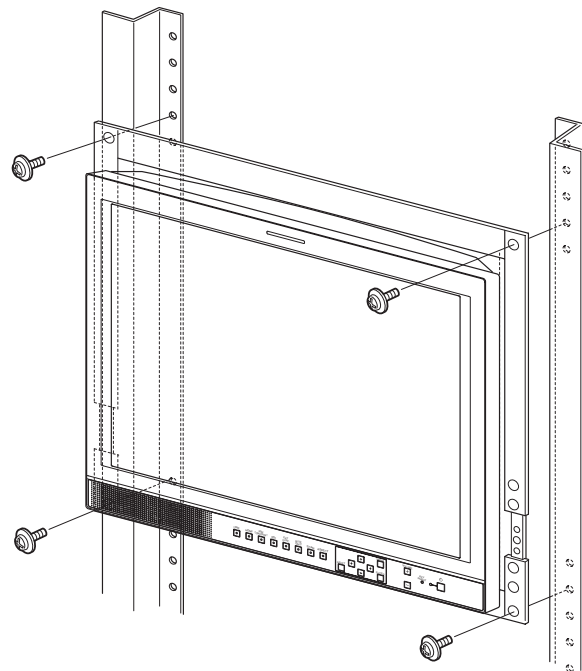

Connecting the AC Power Cord

- 1 Plug the AC power cord into the AC IN socket on the rear panel. Then, attach the AC plug holder (supplied) to the AC power cord.

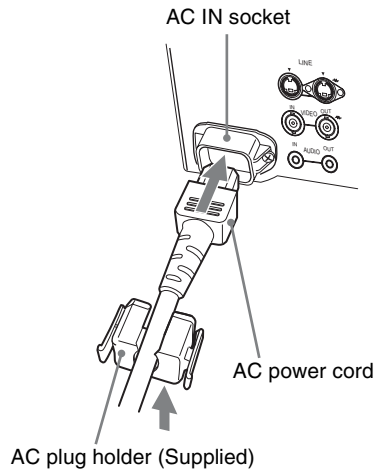

- 2 Slide the AC plug holder over the cord until it locks.

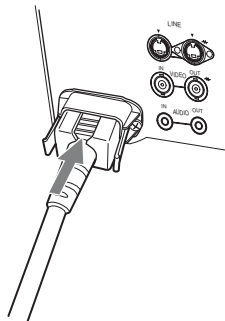

To disconnect the AC power cord

Pull out the AC plug holder while pressing the lock levers.

Attaching the Input Adaptor

Before attaching the input adaptor, disconnect the power cord.

BKM-320D

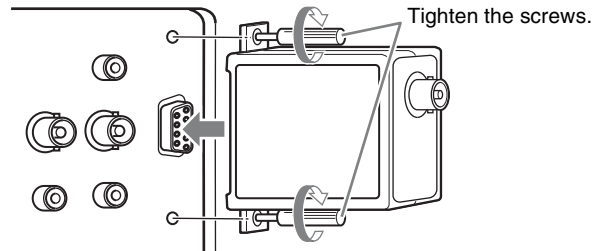

BKM-341HS

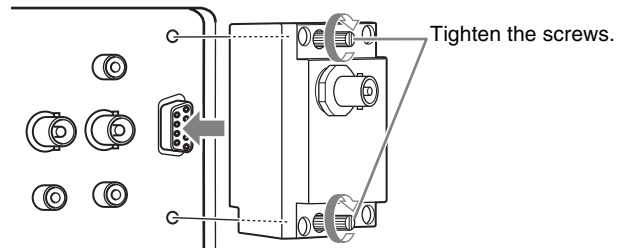

Note

Do not connect the equipment other than BKM-320D or BKM-341HS. It causes damage to the unit or the equipment.

Selecting the Default Settings

When you turn on the unit for the first time after purchasing it, select the area where you intend to use this unit from among the options.

The default setting values for each area

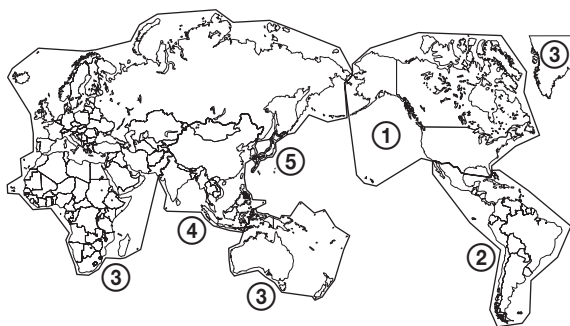

| | | COLOR TEMP | COMPONENT LEVEL | NTSC SETUP |
|--|----------------------------|------------|-----------------|------------|
| ① NORTH AMERICA | | LOW | BETA7.5 | 7.5 |
| ② LATIN AMERICA | ARGENTINA | LOW | SMPTE | 0 |
| | PAL&PAL-N AREA PARAGUAY | LOW | SMPTE | 0 |
| | URUGUAY | LOW | SMPTE | 0 |
| NTSC&PAL-M AREA | OTHER AREA | LOW | BETA7.5 | 7.5 |
| ③ AFRICA AUSTRALASIA EUROPE MIDDLE-EAST | | LOW | SMPTE | 0 |
| ④ ASIA EXCEPT JAPAN | NTSC AREA | LOW | BETA7.5 | 7.5 |
| | PAL AREA | LOW | SMPTE | 0 |
| ⑤ JAPAN | | HIGH | SMPTE | 0 |

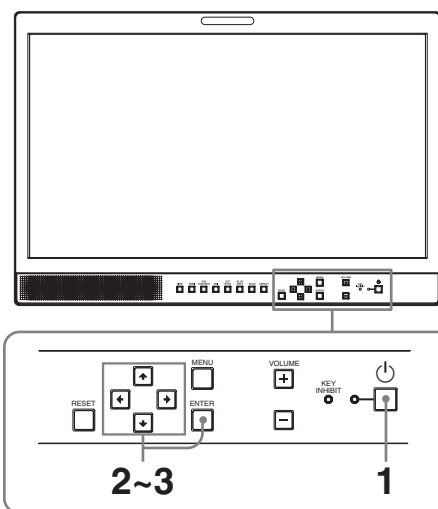

1 Press the ⏻ (standby) switch.

The power is turned on and the SELECT SETTING screen appears.

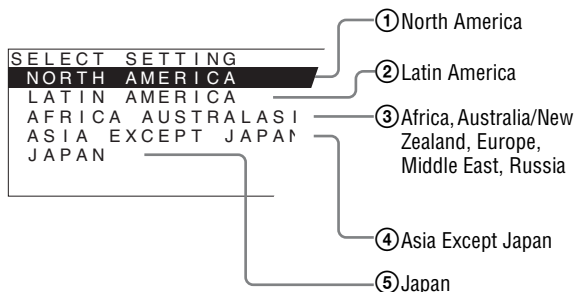

2 Press the ↑ or ↓ button to select the area where you intend to use the unit and press the → or ENTER button.

If you select either ①, ③ or ⑤

The confirmation screen is displayed. Confirm the selected area. When the setting is wrong, press the ← button to return to the previous screen.

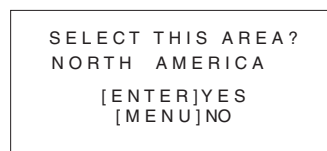

If you select either ② or ④

One of the following screens appears. Press the ↑ or ↓ button to narrow the area further and then press the → or ENTER button.

The confirmation screen is displayed. Confirm the selected area. When the setting is wrong, press the ← button to return to the previous screen.

② If LATIN AMERICA is selected:

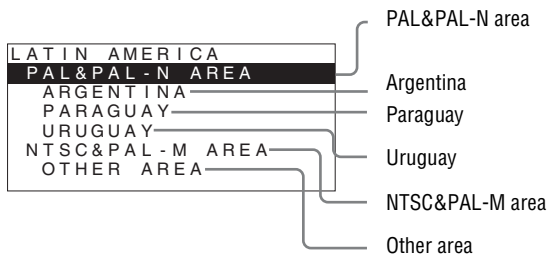

④ If ASIA EXCEPT JAPAN is selected:

Customers who will use this unit in the shaded areas shown in the map below should select NTSC AREA.

Other customers should select PAL AREA.

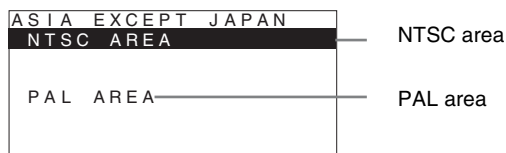

- 3 Press the **↑** or **↓** button to narrow the area further and then press the **→** or ENTER button.

The SELECT SETTING screen disappears and the menu item settings suitable for the selected area are applied.

Note

When you have selected the wrong area, set the following items using the menu.

- COLOR TEMP (on page 17)
- COMPONENT LEVEL (on page 18)
- NTSC SETUP (on page 18)

See “The default setting values for each area” (page 13) on the setting value.

Selecting the Menu Language

You can select one of seven languages (English, French, German, Spanish, Italian, Japanese, Chinese) for displaying the menu and other on-screen displays. “ENGLISH (English)” is selected in the default setting. The current settings are displayed in place of the **■** marks on the illustrations of the menu screen.

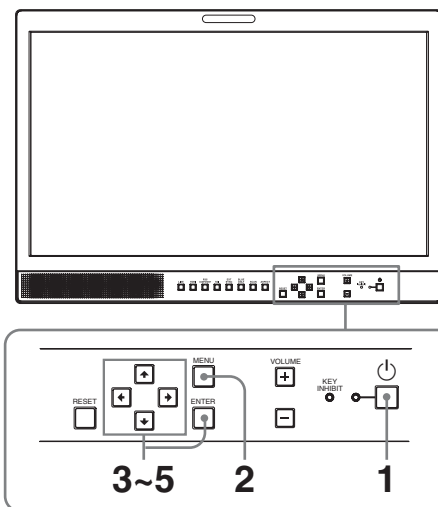

- 1 Press the **⏻** (standby) switch to turn on the unit.
- 2 Press the MENU button.

The menu appears.

The menu presently selected is shown in yellow.

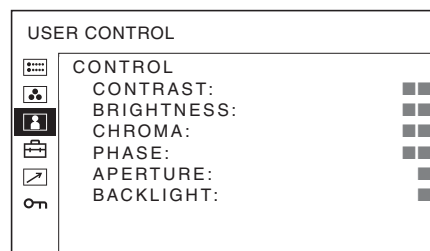

- 3 Press the **↑** or **↓** button to select SYSTEM SETTING of the USER CONFIG (User Configuration) menu, then press the **→** or ENTER button.

The setting items (icons) in the selected menu are displayed in yellow.

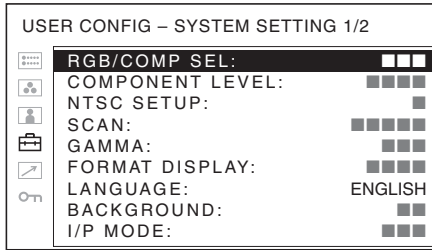

- 4** Press the **↑** or **↓** button to select “LANGUAGE,” then press the **→** or ENTER button.

The selected item is displayed in yellow.

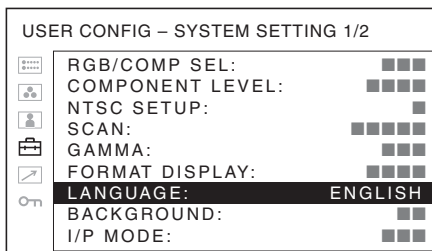

- 5** Press the **↑** or **↓** button to select a language, then press the **→** or ENTER button.

The menu changes to the selected language.

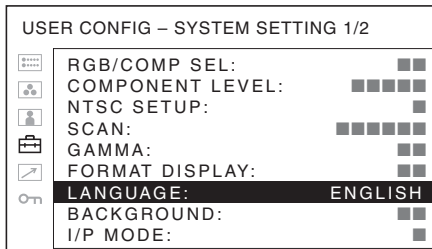

To clear the menu

Press the MENU button.

The menu disappears automatically if a button is not pressed for one minute.

Using the Menu

The unit is equipped with an on-screen menu for making various adjustments and settings such as picture control, input setting, set setting change, etc. You can also change the menu language displayed in the on-screen menu.

To change the menu language, see “Selecting the Menu Language” on page 14.

The current settings are displayed in place of the **■** marks on the illustrations of the menu screen.

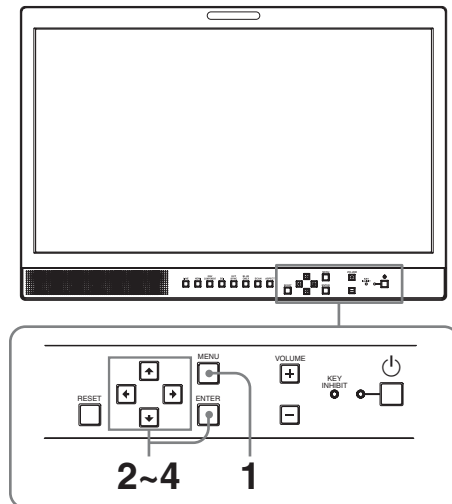

- 1** Press the MENU button.

The menu appears.

The menu presently selected is shown in yellow.

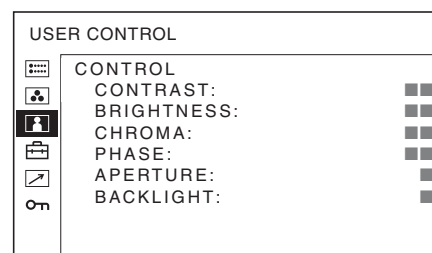

- 2** Press the **↑** or **↓** button to select a menu, then press the **→** or ENTER button.

The menu icon presently selected is shown in yellow and setting items are displayed.

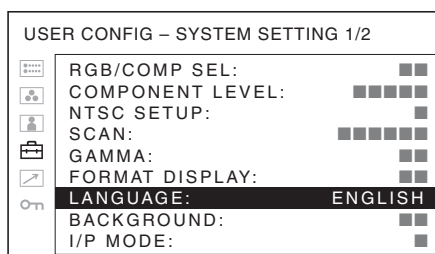

3 Select an item.

Press the **↑** or **↓** button to select the item, then press the **→** or ENTER button. The item to be changed is displayed in yellow.

Note

If the menu consists of multiple pages, press **↑** or **↓** button to go to the desired menu page.

4 Make the setting or adjustment on an item.

When changing the adjustment level:

To increase the number, press the **↑** button.
To decrease the number, press the **↓** button.
Press the ENTER button to confirm the number, then restore the original screen.

When changing the setting:

Press the **↑** or **↓** button to change the setting.
Press the ENTER button to confirm the setting.

Notes

- An item displayed in black cannot be accessed. You can access the item if it is displayed in white.
- If the key inhibit has been turned on, all items are displayed in black. To change any of the items, turn the key inhibit to OFF first.

For details on the key inhibit, see “KEY INHIBIT menu” (page 21).

To clear the menu

Press the MENU button.
The menu disappears automatically if a button is not pressed for one minute.

About the memory of the settings

The settings are automatically stored in the monitor memory.

To reset items that have been adjusted

Pressing the RESET button while you are adjusting any of the menu items resets the menu item to the previous setting.

Adjustment Using the Menus

Items

The screen menu of this monitor consists of the following items.

STATUS (the items indicate the current settings.)

For the video input

FORMAT
COLOR TEMP
GAMMA
COMPONENT LEVEL
NTSC SETUP
RGB/COMP SEL
SCAN MODE
Model name and serial number
OPTION

For the DVI input

FORMAT
fH
fV
COLOR TEMP
Model name and serial number
OPTION

COLOR TEMP/BAL

COLOR TEMP
MANUAL ADJUSTMENT

USER CONTROL

CONTROL

USER CONFIG

SYSTEM SETTING
RGB/COMP SEL
COMPONENT LEVEL
NTSC SETUP
SCAN
GAMMA
FORMAT DISPLAY
LANGUAGE
BACKGROUND
I/P MODE
SD PIXEL MAPPING
MARKER SETTING
MARKER ENABLE

MARKER SELECT
 CENTER MARKER
 SAFETY AREA
 MARKER LEVEL

REMOTE

PARALLEL REMOTE

- 1PIN
- 2PIN
- 3PIN
- 4PIN
- 6PIN
- 7PIN
- 8PIN

KEY INHIBIT

KEY INHIBIT

Adjusting and Changing the Settings

STATUS menu

The STATUS menu is used to display the current status of the unit. The following items are displayed:

For the video input

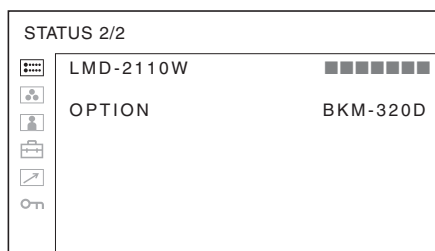
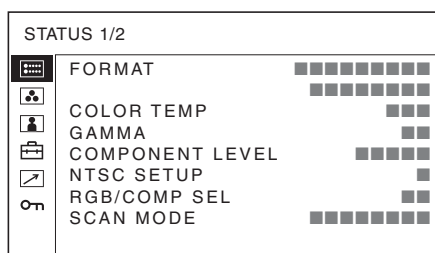

- Signal format
- Color temperature
- Gamma
- Component level
- NTSC setup
- RGB/Component select
- Scan mode
- Model name and serial number
- Option

For the DVI input

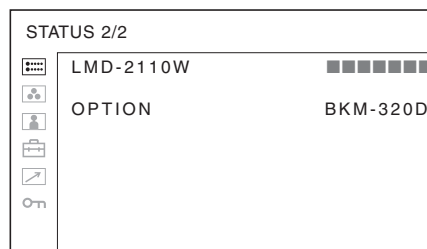
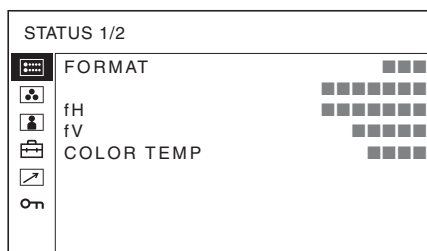

- Signal format
- fH
- fV
- Color temperature
- Model name and serial number
- Option

COLOR TEMP/BAL menu

The COLOR TEMP/BAL menu is used for adjusting the picture white balance.

You need to use the measurement instrument to adjust the white balance.

Recommended: Konica Minolta color analyzer CA-210

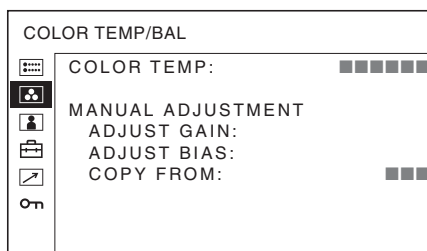

| Submenu | Setting |
|------------|--|
| COLOR TEMP | Selects the color temperature from among HIGH, LOW and USER setting. |

| Submenu | Setting |
|-------------------|---|
| MANUAL ADJUSTMENT | <p>If you set the COLOR TEMP to USER setting, the item displayed is changed from black to white, which means you can adjust the color temperature.</p> <ul style="list-style-type: none"> • ADJUST GAIN: Adjusts the color balance (GAIN). • ADJUST BIAS: Adjusts the color balance (BIAS). • COPY FROM: If you select HIGH or LOW, the white balance data for the selected color temperature will be copied in the USER setting. |

USER CONTROL menu

The USER CONTROL menu is used for adjusting the picture.

Items that cannot be adjusted depending on the input signal are displayed in black.

For details of input signal and adjustable / setting items, see page 9.

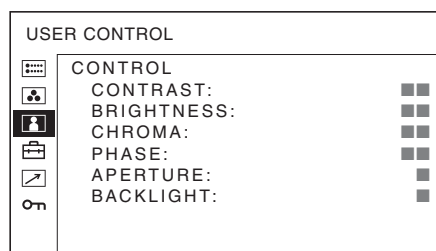

| Submenu | Setting |
|---------|--|
| CONTROL | <p>You can adjust the picture.</p> <ul style="list-style-type: none"> • CONTRAST: Adjusts the picture contrast. • BRIGHTNESS: Adjusts the picture brightness. • CHROMA: Adjusts color intensity. The higher the setting, the greater the intensity. The lower the setting, the lower the intensity. • PHASE: Adjusts color tones. The higher the setting, the more greenish the picture. The lower the setting, the more purplish the picture. • APERTURE: Adjusts the picture sharpness. The higher the setting, the sharper the picture. The lower the setting, the softer the picture. • BACKLIGHT: Adjusts the backlight. When the setting is changed, the brightness of the backlight is changed. |

USER CONFIG menu

The USER CONFIG menu is used for setting the system and marker. You can set the display language and so on. Items that cannot be adjusted depending on the input signal are displayed in black.

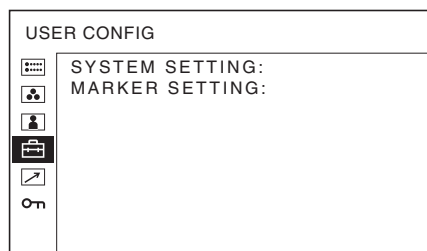

SYSTEM SETTING

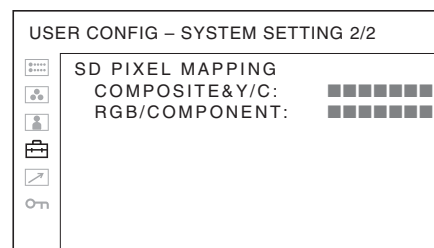
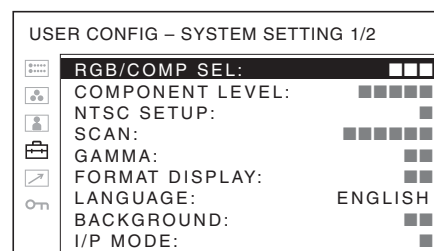

| Submenu | Setting |
|-----------------|---|
| RGB/COMP SEL | When a signal input via the RGB/COMPONENT connector is being monitored, based on the signal being input, select RGB or COMP (component). |
| COMPONENT LEVEL | <p>Selects the component level from among three modes.</p> <ul style="list-style-type: none"> • SMPTE: for 100/0/100/0 signal • BETA0: for 100/0/75/0 signal • BETA7.5: for 100/7.5/75/7.5 signal |
| NTSC SETUP | <p>Selects the NTSC setup level from two modes.</p> <p>The 7.5 setup level is used mainly in North America. The 0 setup level is used mainly in Japan.</p> |

| Submenu | Setting |
|----------------------------------|--|
| SCAN | <p>Sets the scan size of the picture. Select from OFF and FULL. The display format changes depending on the mode selected. (See “Scan mode image” on page 20)</p> <ul style="list-style-type: none"> • OFF: Changes between over scan and normal scan. • FULL: Changes to over scan, normal scan or full screen. |
| GAMMA | <p>Select the appropriate gamma mode. You can select from among five settings. When "3" is selected, the setting is roughly same as the gamma mode of the CRT (2.2).</p> |
| FORMAT DISPLAY | <p>Selects the display mode of the signal format.</p> <ul style="list-style-type: none"> • ON: The format is always displayed. • OFF: The display is hidden. • AUTO: The format is displayed for about five seconds when the input of the signal starts. |
| LANGUAGE | <p>Selects the menu or message language from among seven languages.</p> <ul style="list-style-type: none"> • ENGLISH: English • FRANÇAIS: French • DEUTSCH: German • ESPAÑOL: Spanish • ITALIANO: Italian • 日本語 : Japanese • 中文 : Chinese |
| BACKGROUND | <p>Sets the brightness of the black bars appearing in the upper and lower positions of the screen, or on the sides of the screen.</p> <ul style="list-style-type: none"> • OFF: Displays a darker bar (black). • ON: Displays a brighter bar (gray). |
| I/P MODE (picture delay minimum) | <p>Select to set the delay by the picture processing to the minimum level when the signal is input.</p> <ul style="list-style-type: none"> • INTER-FIELD: Performs interpolation depending on the movement of the images between the fields. It takes longer than “LINE DOUBLER” for processing the picture. “INTER-FIELD” is the factory setting. • LINE DOUBLER: The processing time is shorter. Performs interpolation by repeating each line in the data receiving sequence regardless of the field. As the line flicker is displayed in this mode, it is available for checking the line flicker of the telop work and so on. |

| Submenu | Setting |
|------------------|---|
| SD PIXEL MAPPING | <p>Selects SD picture size (pixels) according to input signal format.</p> <ul style="list-style-type: none"> • COMPOSITE&Y/C: Set to monitor the signal input through the LINE connector (VIDEO IN or Y/C IN connector). • RGB/COMPONENT: Set to monitor the signal input through the RGB/COMPONENT connector. <p>When picture signals in the size of 720 × 576 (50i) (or 720 × 487 (60i)) are input Select 720 × 576 (or 720 × 487). This is the default setting. When 702 × 576 (or 712 × 483) is selected, all sides of the input picture are cut off by several pixels.</p> <p>When picture signals in the size of 702 × 576 (50i) (or 712 × 483 (60i)) or equivalent are input Select 702 × 576 (or 712 × 483). When 720 × 576 (or 720 × 487) is selected, a black border (of several pixels wide) appears around the input picture.</p> |

Scan mode image

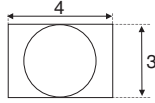
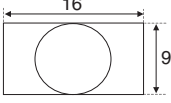
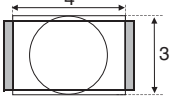
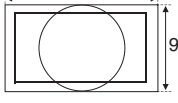
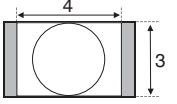
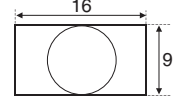
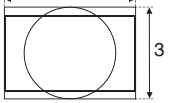
| | | Input | |
|--------|----------------------------|--|---|
| | |  |  |
| Output | OVER SCAN (5% OVER SCAN) |  |  |
| | NORMAL SCAN (0% OVER SCAN) |  |  |
| | FULL |  | - |

MARKER SETTING

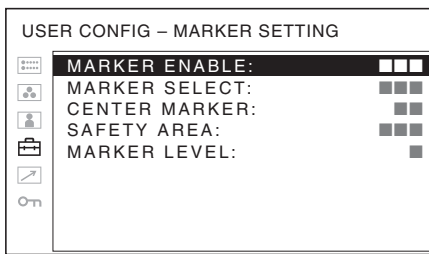

| Submenu | Setting |
|---------------|---|
| MARKER ENABLE | Selects ON to display the marker and OFF not to display. |
| MARKER SELECT | When the frame of the film is displayed on the screen, select the aspect ratio according to the film. When 16:9 aspect ratio is selected with the ASPECT select button You can select either 4:3 or OFF. When 4:3 aspect ratio is selected with the ASPECT select button You can select either 16:9 or OFF. |

| Submenu | Setting |
|---------------|---|
| CENTER MARKER | Select ON to display the center mark of the picture and OFF not to display. |
| SAFETY AREA | Selects the safe area size for the aspect ratio determined by the button which the aspect function is assigned. You can select from among OFF, 80%, 85%, 88%, 90% and 93%. When the marker is displayed, the safe area for the marker is displayed. |
| MARKER LEVEL | Sets the luminance to display the MARKER SELECT, CENTER MARKER and SAFETY AREA. When the setting is low, the marker is displayed dark. |

REMOTE menu

Select the PARALLEL REMOTE connector pins for which you want to change the function.

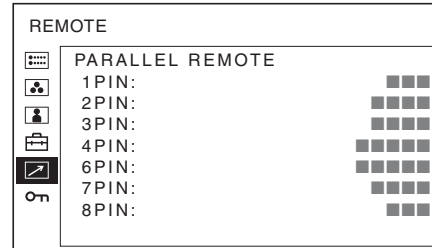

You can assign various functions to 1 to 4 pins and 6 to 8 pins. The following lists the functions you can assign to the pins.

REMOTE

- --- ("---": No function is assigned.)
- LINE
- HDMI
- RGB/COMP
- 16:9
- 4:3
- NORMAL
- OVER
- FULL
- TALLY R
- TALLY G
- EXT SYNC
- BLUE ONLY
- 16:9 MARKER
- 4:3 MARKER
- CENTER MARKER
- SAFE AREA 80%
- SAFE AREA 85%
- SAFE AREA 88%
- SAFE AREA 90%
- SAFE AREA 93%

- SDI

If you use the PARALLEL REMOTE function, you need to connect cables.

For more details, see page 23.

KEY INHIBIT menu

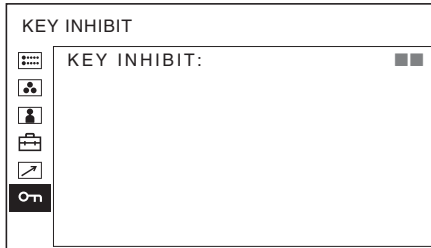

You can lock the setting so that they cannot be changed by an unauthorized user.

Select OFF or ON.

If you set to ON, all items are displayed in black, indicating the items are locked.

Troubleshooting

This section may help you isolate the cause of a problem and as a result, eliminate the need to contact technical support.

- **The display is colored in green or purple** → Select the correct input from the RGB/COMP SEL setting in the USER CONFIG menu (page 18).
- **The unit cannot be operated** → The key protection function works. Set the KEY INHIBIT setting to OFF in the KEY INHIBIT menu.

Specifications

Picture performance

| | |
|--|--|
| LCD panel | a-Si TFT Active Matrix |
| Picture size | 21.5 type 477 × 268, 547 mm (W/H, Diagonal) (18 ⁷ / ₈ × 10 ⁵ / ₈ , 21 ⁵ / ₈ inches) |
| Resolution | 1920 × 1080 dots |
| Viewing angle (LCD panel specifications) | (up/down/left/right, contrast > 10:1) 80°/80°/85°/85° (typical) |
| Scan | Normal 0% Over 5% |
| Aspect | 16:9 |
| Display color | 16,770,000 |

Input/output connectors

Input

| | |
|---------------------------------------|--|
| LINE input connectors | |
| Y/C input | 4-pin mini-DIN (1) |
| VIDEO input | BNC type (1), 1 V _{p-p} ±3 dB, negative synchronization |
| AUDIO input | Phono jack (1), -5 dBu 47 kΩ or higher |
| RGB/COMPONENT input connectors | BNC type (3) |
| RGB input | 0.7 V _{p-p} ±3 dB, (Sync On Green, 0.3 V _{p-p} negative sync.) |
| Component input | 0.7 V _{p-p} ±3 dB, (75% chrominance standard color bar signal) |
| AUDIO input | Phono jack (1), -5 dBu 47 kΩ or higher |
| OPTION IN connector | D-sub 9-pin (1), female |
| OPTION AUDIO IN connector | Phono jack (1), -5 dBu 47 kΩ or higher |
| External synchronized input connector | BNC type (1), 0.3 to 4 V _{p-p} ± bipolarity ternary or negative polarity binary |
| HDMI IN connector | HDMI (1) |
| PARALLEL REMOTE input connector | Parallel remote Modular connector 8-pin (1) |

Output

LINE output connectors

Y/C output 4-pin mini-DIN (1), Loop-through, with 75 Ω automatic terminal function

VIDEO output

BNC type (1), Loop-through, with 75 Ω automatic terminal function

AUDIO output

Phono jack (1), Loop-through

RGB/COMPONENT output connectors

RGB/Component output

BNC type (3), Loop-through, with 75 Ω automatic terminal function

AUDIO output

Phono jack (1), Loop-through

External synchronized output connector

BNC type (1), Loop-through, with 75 Ω automatic terminal function

Built-in speaker output

0.5 W (mono)

General

| | |
|----------------------------------|--|
| Power | AC 100 to 240 V, 50/60 Hz |
| Power consumption | Maximum: approx. 69 W, 1.3 A to 0.6 A |
| Inrush current | (1) Maximum possible inrush current at initial switch-on (Voltage changes caused by manual switching): 60A peak, 0.4A r.m.s. (240V AC) (2) Inrush current after a mains interruption of five seconds (Voltage changes caused at zero-crossing): 48A peak, 0.3A r.m.s. (240V AC) |
| Operating conditions | |
| Temperature | 0 °C to 35 °C (32 °F to 95 °F) |
| Recommended temperature | 20 °C to 30 °C (68 °F to 86 °F) |
| Humidity | 30% to 85% (no condensation) |
| Pressure | 700 hPa to 1060 hPa |
| Storage and transport conditions | |
| Temperature | -20 °C to +60 °C (-4 °F to +140 °F) |
| Humidity | 0% to 90% |
| Pressure | 700 hPa to 1060 hPa |
| Accessories supplied | AC power cord (1) AC plug holder (1) Operating Instructions (1) CD-ROM (1) Using the CD-ROM Manual (1) |
| Optional accessories | Mounting bracket MB-529 SDI input adaptor BKM-320D |

HD/SD-SDI input adaptor BKM-341HS

Design and specifications are subject to change without notice.

Note

Always verify that the unit is operating properly before use. SONY WILL NOT BE LIABLE FOR DAMAGES OF ANY KIND INCLUDING, BUT NOT LIMITED TO, COMPENSATION OR REIMBURSEMENT ON ACCOUNT OF THE LOSS OF PRESENT OR PROSPECTIVE PROFITS DUE TO FAILURE OF THIS UNIT, EITHER DURING THE WARRANTY PERIOD OR AFTER EXPIRATION OF THE WARRANTY, OR FOR ANY OTHER REASON WHATSOEVER.

Pin assignment

PARALLEL REMOTE connector

Modular connector
(8-pin)

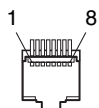

| Pin number | Functions |
|------------|--|
| 1 | Designating LINE input signal |
| 2 | Designating HDMI input signal |
| 3 | Designating RGB/COMPONENT input signal |
| 4 | 16:9 |
| 5 | GND |
| 6 | 4:3 |
| 7 | Selecting NORMAL |
| 8 | Selecting OVER |

For details on function allocations, see *REMOTE menu* (page 20).

Wiring required to use the Remote Control

Connect the function you want to use with a Remote Control to the Ground (Pin 5).

Video signal formats

The unit is applicable to the following signal formats.

| System | Total lines | Active lines | Frame rate | Scanning format | Aspect ratio | Signal standard |
|-------------------|-------------|--------------|------------|-----------------|--------------|----------------------------------|
| 575/50I (PAL) | 625 | 575 | 25 | 2:1 interlace | 16:9/4:3 | EBU N10 (PAL: ITU-R BT.624) |
| 480/60I (NTSC) *1 | 525 | 483 | 30 | 2:1 interlace | 16:9/4:3 | SMPTE 253M (NTSC: SMPTE 170M) |
| 576/50P | 625 | 576 | 50 | Progressive | 16:9/4:3 | ITU-R BT.1358 |
| 480/60P | 525 | 483 | 60 | Progressive | 16:9/4:3 | SMPTE 293M |
| 1080/24P *1 | 1125 | 1080 | 24 | Progressive | 16:9 | SMPTE 274M |
| 1080/25P | 1125 | 1080 | 25 | Progressive | 16:9 | SMPTE 274M |
| 1080/30P *1 | 1125 | 1080 | 30 | Progressive | 16:9 | SMPTE 274M |
| 1080/50I | 1125 | 1080 | 25 | 2:1 interlace | 16:9 | SMPTE 274M |
| 1080/60I *1 | 1125 | 1080 | 30 | 2:1 interlace | 16:9 | SMPTE 274M/BTA S-001B |
| 720/50P | 750 | 720 | 50 | Progressive | 16:9 | SMPTE 296M |
| 720/60P *1 | 750 | 720 | 60 | Progressive | 16:9 | SMPTE 296M |

*1 Also supports frame rate 1/1.001.

Applicable DVI input signals

When a PC signal is input to the HDMI IN connector using a DVI conversion cable

| Resolution | Dot clock (MHz) | fH (kHz) | fV (Hz) |
|------------------|-----------------|----------|---------|
| 720 × 400 70Hz | 28.322 | 31.469 | 70.087 |
| 800 × 600 56Hz | 36.000 | 35.156 | 56.250 |
| 800 × 600 60Hz | 40.000 | 37.879 | 60.317 |
| 1024 × 768 60Hz | 65.000 | 48.363 | 60.004 |
| 1280 × 1024 60Hz | 108.000 | 63.981 | 60.020 |

Note

The sides of the displayed picture may be invisible depending on the input signal.

When an optional input adaptor is connected, the unit is applicable to the following signal formats.

When BKM-320D/BKM-341HS is connected

| System | Input | | Signal standard |
|---------------|----------|-----------|-----------------|
| | BKM-320D | BKM-341HS | |
| 575/50I | ○ | ○ | SMPTE 259M |
| 480/60I *1 | ○ | ○ | SMPTE 259M |
| 1080/24PsF *1 | – | ○ | SMPTE 292M |
| 1080/25PsF | – | ○ | SMPTE 292M |
| 1080/24P *1 | – | ○ | SMPTE 292M |
| 1080/25P | – | ○ | SMPTE 292M |
| 1080/30P *1 | – | ○ | SMPTE 292M |

| System | Input | | Signal standard |
|-------------|----------|-----------|-----------------|
| | BKM-320D | BKM-341HS | |
| 1080/50I | – | ○ | SMPTE 292M |
| 1080/60I *1 | – | ○ | SMPTE 292M |
| 720/50P | – | ○ | SMPTE 292M |
| 720/60P *1 | – | ○ | SMPTE 292M |

○ : Can be input
– : Cannot be input

*1 The frame rate is also compatible with 1/1.001.

Dimensions

Front

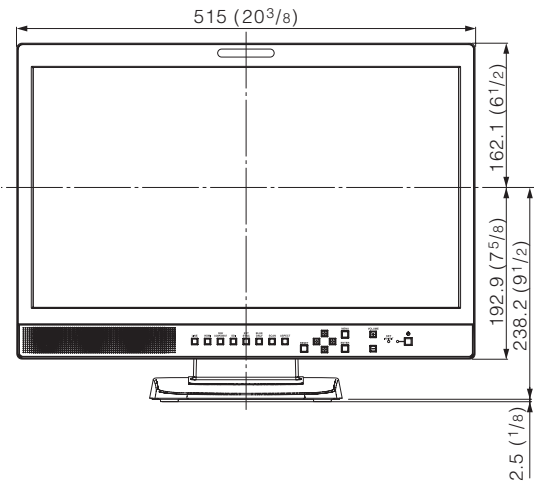

Side

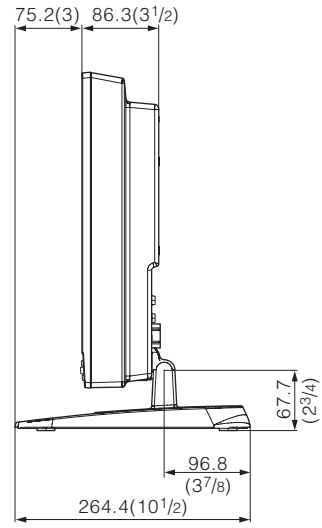

Rear

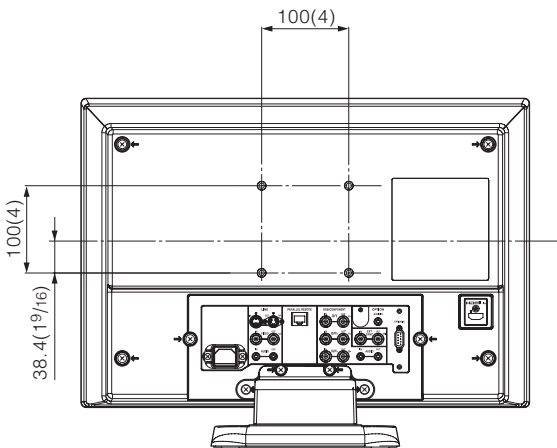

Bottom

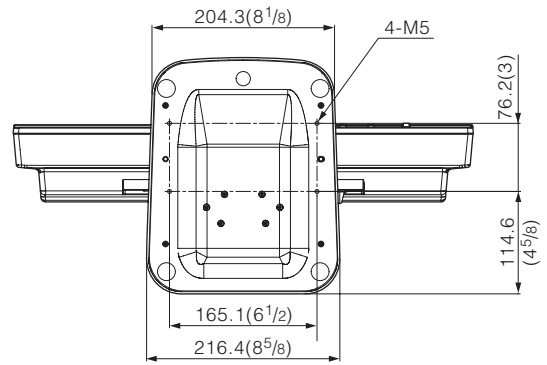

Unit: mm (inches)

Mass:
Approx. 8.6 kg (18 lb 15 oz)

