

Interchangeable Lens Digital HD Video Camera Recorder

Operating Guide

E-mount

Table of Contents

Getting Started

Recording

Playback

Editing

Using the Menu

Connecting with another
device

Troubleshooting

Additional Information

NXCAM

AVCHD
Progressive

InfoLITHIUM™ L
SERIES

MEMORY STICK™

S2
XC
CLASS C

HDMI™
HIGH-DEFINITION MULTIMEDIA INTERFACE

Read this first

Before operating this unit, please read this manual thoroughly, and retain it for future reference.

Notes on use

Using the camcorder

- Do not hold the camcorder by the following parts, and also do not hold the camcorder by the jack covers.

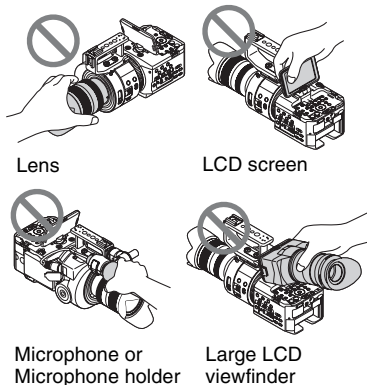

for effective use. However, there may be some tiny black points and/or bright points (white, red, blue, or green in color) that appear constantly on the LCD screen. These points are normal results of the manufacturing process and do not affect the recording in any way.

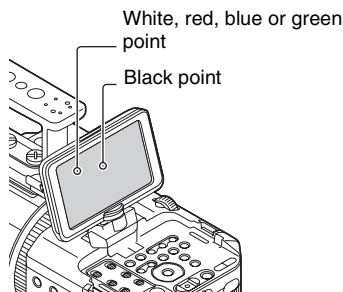

On sunlight

- Do not record the sun or leave the camcorder under the sun for a long time. The internal parts of the camcorder may be damaged. If sunlight is focused on a nearby object, it may cause a fire. When you must place the camcorder under direct sunlight, attach the front lens cap.
- Do not expose your camcorder's viewfinder, lens, or LCD screen to the sun or strong light source for extended periods. Doing so may cause a malfunction of the camcorder.
- Do not attempt to record the sun directly. Doing so may cause a malfunction of the camcorder.
- Do not look at the sun or a strong light through a removed lens. This may cause irrecoverable damage to your eyes. Also, this may cause a malfunction.

Notes

- The camcorder is not dustproof, dripproof or waterproof. See "About handling of your camcorder" (p. 126).
- When connecting the camcorder to another device with communication cables, be sure to insert the connector plug in the correct way. Pushing the plug forcibly into the terminal will damage the terminal and may result in a malfunction of the camcorder.
- Use your camcorder in accordance with country/region regulations.

On the LCD screen and lens

- A menu item that is grayed out is not available under the current recording or playback conditions.
- The LCD screen is manufactured using extremely high-precision technology, so over 99.99% of the pixels are operational

On the temperature of your camcorder and battery pack

Your camcorder has a protective function that disables recording or playback if the temperature of your camcorder or battery pack is beyond the safely operable range. In

this case, a message appears on the LCD screen (p. 117).

On recording

- In order to stabilize memory card operation, it is recommended that you format the memory card when you use it with your camcorder for the first time. All data recorded on the memory card will be erased by formatting, and cannot be recovered. Save important data on the memory card on other media such as a computer, before formatting the memory card.
- Before starting to record, test the recording function to make sure the picture and sound are recorded without any problems.
- Compensation for the loss of the content of recordings or the loss of recording opportunities cannot be provided, even if recording or playback is not possible due to a malfunction of the camcorder, storage media, etc., or even if images or sounds are distorted due to the limits of the capabilities of the camcorder.
- TV color systems differ depending on the countries/regions. To view your recordings on a TV, you need to set [60i/50i SEL] in accordance with the country/region.
- Television programs, films, video tapes, and other materials may be copyrighted. Unauthorized recording of such materials may be contrary to the copyright laws.
- Because of the way that the image device (CMOS sensor) reads out image signals, the following phenomena may occur.
 - The subjects passing by the frame rapidly might appear crooked depending on the recording conditions. (This phenomenon may be notable in displays having high motion resolution.)
 - Horizontal lines appear on the LCD screen during recording under fluorescent lights, sodium lamps or mercury lamps. The phenomena can be reduced by adjusting the shutter speed (p. 45).

- Images on the LCD screen look horizontally divided when a subject is continuously lit with a flash. The effect of this phenomenon may be reduced by using a slower shutter speed. Also, you may try using the “Content Management Utility” software on the supplied CD-ROM to repair the image.

DVD media recorded with high definition image quality (HD)

DVD media recorded with high definition image quality (HD) can be played back with devices that are compatible with the AVCHD format. You cannot play discs recorded with high definition image quality (HD) with DVD players/recorders as they are not compatible with the AVCHD format. If you insert a disc recorded with the AVCHD format (high definition image quality (HD)) into a DVD player/recorder, you may not be able to eject the disc.

Save all your recorded image data

- To prevent your image data from being lost, save all your recorded images on external media periodically. To save images on a computer, see page 107. To save images on an external device, see page 104.
- Movies recorded with the recording mode set to PS or FX on [HD] REC FORMAT] can be saved on an external media device and Blu-ray disc only (p. 104).

To handle the recorded images on your computer

Refer to “Help” on the supplied CD-ROM “Content Management Utility.”

Format the recording media using [MEDIA FORMAT] if images are not recorded or played back properly

If you continue recording and deleting images on recording media for a long time, the files on that recording media may be fragmented. As a result, you may not be able to record and save images properly. If

Read this first (Continued)

this happens, save images on a separate recordable media, such as a disc or computer, then format the recording media (p. 80).

About the operation of the camcorder

You can operate the camcorder using the SEL/PUSH EXEC dial (p. 28, 82), \blacktriangle / \blacktriangledown / \blacktriangleleft / \blacktriangleright /EXEC buttons (p. 82), and the touch panel. However, you cannot use the touch panel to make some settings such as the MENU items.

About this manual

- Operations in the manual are described using the E 18-200mm F3.5-6.3 OSS lens supplied with the NEX-FS700UK/FS700EK/FS700K. When the operation differs depending on the lens used, you will find the relevant information in “Notes” or “Tips.”
- The value you can set in [HD] REC FORMAT], etc., depends on the [60i/50i SEL] setting. In this manual, the values for both [60i] and [50i] settings are described.
- Memory cards and a flash memory unit are both referred to as recording media in this manual.
- The images of the LCD screen used in this manual for illustration purposes are captured using a digital still camera, and therefore may appear different.
- The on-screen displays in each local language are used for illustrating the operating procedures. Change the screen language before using your camcorder if necessary (p. 29).
- Design and specifications of recording media and other accessories are subject to change without notice.

About the location of the nameplate

The nameplate is located on left side of the unit (circled below).

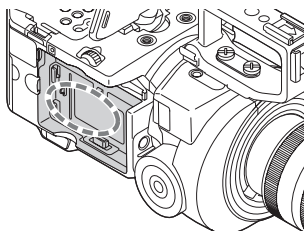

Identifying parts and controls

Body

The numbers in () are reference pages.

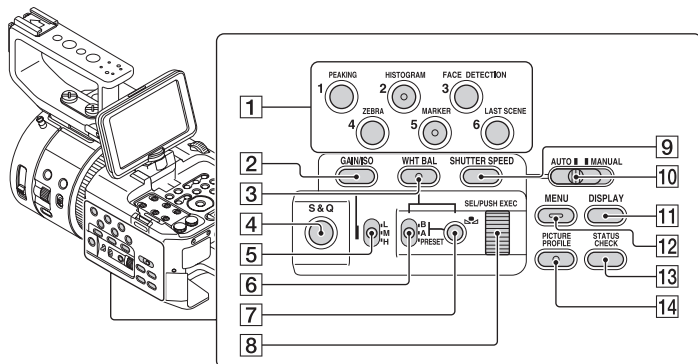

1 ASSIGN 1/2*/3/4/5*/6 button (64)

2 GAIN/ISO button (44)

3 WHT BAL button* (47)

4 S&Q button (49)

5 Gain/ISO switch (44)

6 White balance memory switch (47)

7  (one push) button (47)

8 SEL/PUSH EXEC dial (28, 82)

9 SHUTTER SPEED button (45)

10 AUTO/MANUAL switch (43)

11 DISPLAY button (70)

12 MENU button** (28, 82)

13 STATUS CHECK button (71)

14 PICTURE PROFILE button* (56)

* ASSIGN 2 button, ASSIGN 5 button, PICTURE PROFILE button, and WHT BAL button have raised tactile dots for your convenience in locating the buttons.

**MENU button has a raised tactile bar for your convenience in locating the buttons.

Identifying parts and controls (Continued)

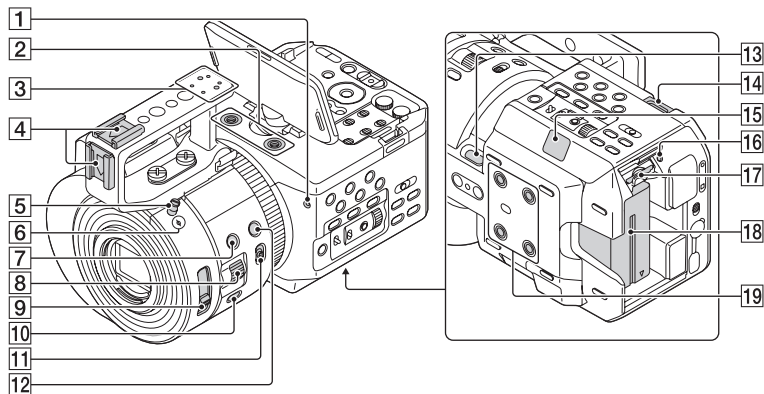

1 Front recording lamp (102)

The recording lamp flashes if the remaining capacity of recording media or battery is low.

2 Expansion receptacles

For 1/4-20UNC screws (shorter than 5.5 mm)

3 Accessory shoe receptacles

4 Accessory shoe (25)

5 Tape measure hook (38)

6 Image sensor position index (38)

7 IRIS PUSH AUTO button (43)

8 Iris ring (43)

9 ND FILTER switch (46)

10 IRIS button (43)

11 FOCUS switch (37)

12 FOCUS HOLD/PUSH AUTO button (38)

13 HOLD switch (63)

14 Hook for cable stopper/shoulder strap

15 BATT RELEASE button (20)

16 Access lamp

17 Memory card slot (31)

18 Battery pack (19)

19 Tripod receptacles

For attaching a tripod

For attaching a tripod with a screw shorter than 5.5 mm (sold separately).

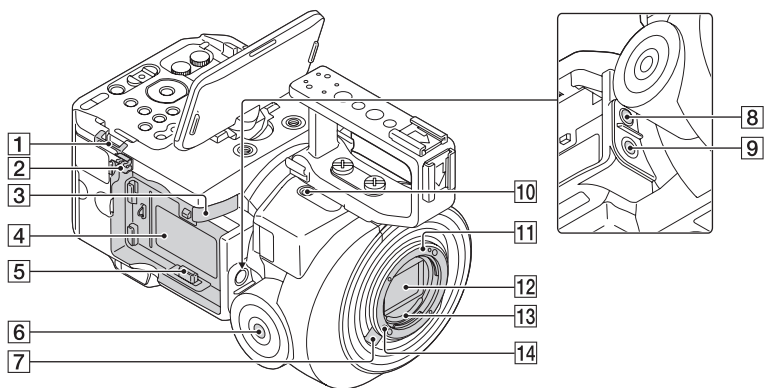

- 1 Hook for cable stopper/shoulder strap
- 2 Cable clamp
- 3 Flash memory unit RELEASE lever (32)
- 4 Flash memory unit mount (32)
- 5 Flash memory unit jack
- 6 Grip respectable (27)
- 7 Lens release button (22)
- 8 PHOTO button (33)
- 9 START/STOP button (33)
- 10 MODE button (33)
- 11 Lens mount (21)
- 12 Image sensor
- 13 Lens contacts
Do not touch or dirty the lens contacts.
- 14 Lens lock pin

To attach a cable stopper (supplied)

Attach a cable stopper (supplied) to the hooks for cable stopper/shoulder strap.

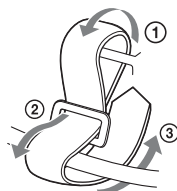

Identifying parts and controls (Continued)

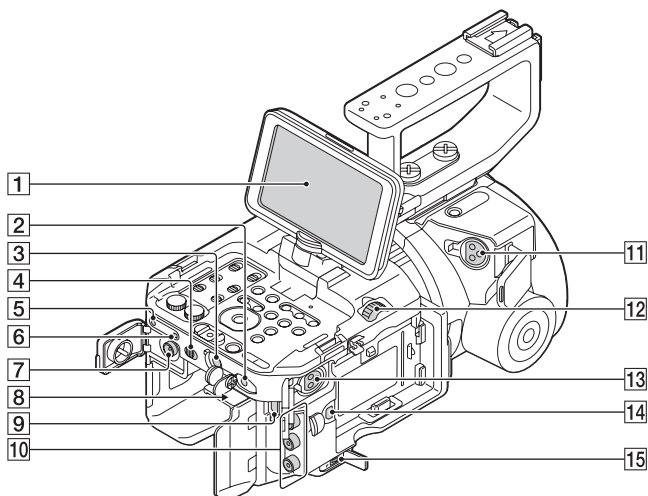

1 LCD screen/touch panel (29)

15 DC IN jack (20)

2 REMOTE jack

The REMOTE jack is used for controlling playback, etc. on the video device and peripherals connected to it.

3  (headphones) jack

For connecting stereo mini-jack headphones.

4 HEADPHONE MONITOR switch (55)

5 Rear recording lamp (102)

The recording lamp flashes if the remaining capacity of recording media or battery is low.

6 Remote sensor (103)

7 3G/HD/SD SDI OUT jack (72)

8 HDMI OUT jack (72)

9 COMPONENT OUT jack (72)

10 VIDEO OUT/AUDIO OUT jacks (72, 106)

11 INPUT 2 jack (26)

12 LCD HOLD dial (29)

13 INPUT 1 jack

14  (USB) jack (104, 107)

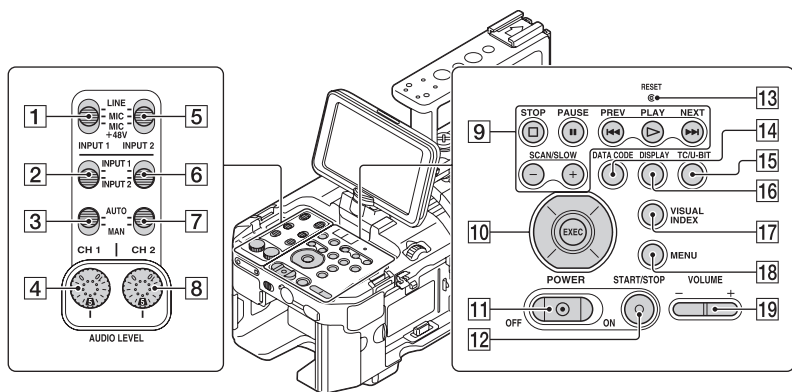

- 1** INPUT 1 switch (53)
- 2** CH1 (INPUT 1/INPUT 2) switch (53)
- 3** CH1 (AUTO/MAN) switch (53)
- 4** AUDIO LEVEL (CH1) dial (53)
- 5** INPUT 2 switch (53)
- 6** CH2 (INPUT 1/INPUT 2) switch (53)
- 7** CH2 (AUTO/MAN) switch (53)
- 8** AUDIO LEVEL (CH2) dial (53)
- 9** Playback control buttons (STOP/PAUSE/PREV/PLAY*/NEXT/SCAN/SLOW) (66)

- 10** ▲/▼/◀/▶/EXEC buttons (82)
- 11** POWER switch (28)
- 12** START/STOP button (33)
- 13** RESET button

If you press the RESET button, all settings including the clock setting (except the picture profile settings) return to the default.

- 14** DATA CODE button (70)
- 15** TC/U-BIT button
- 16** DISPLAY button (70)
- 17** VISUAL INDEX button (66)
- 18** MENU button (28, 82)

- 19** VOLUME buttons* (66)

* VOLUME+ button, and PLAY button have raised tactile dots for your convenience in locating the buttons.

Lens (supplied with NEX-FS700UK/FS700EK/FS700K)

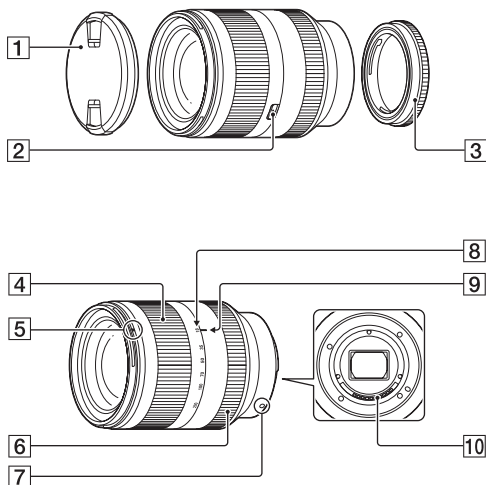

- 1 Front lens cap
- 2 Zoom lock switch
- 3 Rear lens cap
- 4 Zooming ring (36)
- 5 Hood index
- 6 Focusing ring (37)
- 7 Mounting index (21)
- 8 Focal-length scale
- 9 Focal-length index
- 10 Lens contacts

Do not touch or dirty the lens contacts.

Wireless Remote Commander

Remove the insulation sheet before using the Wireless Remote Commander.

Insulation sheet

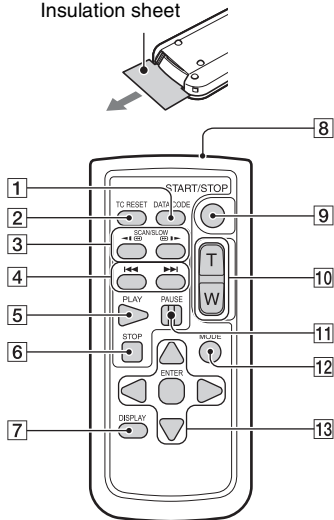

- 1 DATA CODE button (70)
- 2 TC RESET button (62)
- 3 SCAN/SLOW buttons (66)
- 4 ◀▶ (PREV/NEXT) buttons (66)
- 5 PLAY button (66)
- 6 STOP button (66)
- 7 DISPLAY button (70)
- 8 Transmitter
- 9 START/STOP button (33)
- 10 Power zoom buttons
You cannot use this button with this camcorder.
- 11 PAUSE button (66)
- 12 MODE button
- 13 ◀/▶/▲/▼/ENTER buttons

Notes

- Aim the Wireless Remote Commander towards the remote sensor to operate your camcorder.
- Point the remote sensor away from strong light sources such as direct sunlight or overhead lighting. Otherwise, the Wireless Remote Commander may not function properly.
- When you are operating with the Wireless Remote Commander supplied with your camcorder, your video device may also operate. In that case, select a commander mode other than DVD2 for your video device, or cover the sensor of your video device with black paper.

To change the battery of the Wireless Remote Commander

- 1 While pressing on the tab, inset your fingernail into the slit to pull out the battery case.
- 2 Place a new battery with the + side facing up.
- 3 Insert the battery case back into the Wireless Remote Commander until it clicks.

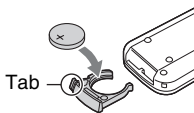

WARNING

Battery may explode if mistreated. Do not recharge, disassemble or dispose of in fire.

- When the lithium battery becomes weak, the operating distance of the Wireless Remote Commander may shorten, or the Wireless Remote Commander may not function properly. In this case, replace the battery with a Sony CR2025 lithium battery. Use of another battery may present a risk of fire or explosion.

Screen indicators

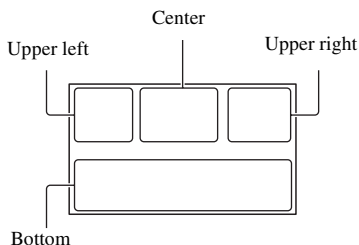

Upper left

Indicator	Meaning
	100% Remaining battery
1080/60i	/ SET (43), REC FORMAT (42)
	WIDE REC (92)
	Image size

Center

Indicator	Meaning
	AE/AF lock
	Vibration warning
	Recording media
REC STBY	Recording status (33)
	Warning (117)
	Playback indicator (66)

Upper right

Indicator	Meaning
Omin	Estimated remaining recording time
	Recording/playback media
00:00:00:00	Time code (hour:minute:second: frame)
	Movie still image capture display

Indicator	Meaning
>9999	Number of recordable still images

Bottom

Indicator	Meaning
1/64ND 1/16ND 1/4ND	ND filter
ON	Face detection [ON]
ISO800	ISO
PEAKING	PEAKING (96)
	ZEBRA (96)
	STEADYSHOT (90)
	Manual focus (37)
PP1 ~ PP6	Picture profile (56)
F3.5	Iris (43)
9dB	Gain (44)
100 180°	Shutter speed (45)
M ₂	Manual volume control (55)
LPCM	AUDIO FORMAT (94)
-2.0EV	AE SHIFT (89)
A	Auto setting (97)
A B	White balance (47)
	HISTOGRAM (95)

💡 Tips

- Indicators may look different or appear at different positions.

Data code during recording

The recording date, time and condition are recorded automatically on the recording media. They are not displayed while recording. However, you can check them by pressing the DATA CODE button (p. 70).

Table of Contents

Read this first	2
Identifying parts and controls	5
Body	5
Lens (supplied with NEX-FS700UK/FS700EK/FS700K)	10
Wireless Remote Commander.....	11
Screen indicators	12

Getting Started

Step 1: Checking supplied items	17
Step 2: Charging the battery pack	19
Step 3: Attaching the lens	21
Step 4: Attaching the handle, microphone and grip	25
Step 5: Turning on the camcorder and setting the date and time	28
Changing the language setting.....	29
Setting [60i/50i SEL]	29
Step 6: Adjusting the LCD screen	29
Step 7: Preparing the recording media	31

Recording

Recording	33
Recording movies	33
Recording still images.....	35
Zooming	36
Adjusting the focus	37
Using automatic focus/fixed focus temporarily (Push auto focus/Focus hold).....	38
Using the expanded focus (Expanded focus)	38
Focusing by touching the LCD screen (Spot focus)	39
Focusing on a detected face (Face detection)	39
Using focus transition.....	40
Changing the recording setting/image size	42
Selecting the recording format for high definition image quality (HD)	42
Selecting high definition image quality (HD) or standard definition image quality (SD).....	43
Selecting the image size for still images	43
Adjusting the brightness	43
Adjusting the iris.....	43
Adjusting the gain/ISO sensitivity.....	44
Adjusting the shutter speed	45
To adjust the amount of light (ND filter).....	46

Adjusting the color tone	47
Adjusting the white balance.....	47
Adjusting the black balance	48
Slow & Quick Motion recording	49
Recording with the Slow & Quick Motion function.....	49
To record with the Super Slow Motion function	50
Audio setup	53
Recording sound via the supplied microphone.....	54
Recording sound from an external audio device.....	54
Adjusting the volume	55
Setting the headphone sound.....	55
Useful functions	56
Customizing the picture quality (Picture profile).....	56
Setting time data	62
Preventing accidental operation (HOLD switch).....	63
Reviewing the most recently recorded scene (Last Scene Review)...	63
Assigning the functions to the ASSIGN buttons	64

Playback

Playback	66
Playing back movies	66
Playing back still images	69
Changing/checking the settings in your camcorder	70
Changing the screen display	70
Displaying recording data (Data code)	70
Checking the settings in your camcorder (Status check).....	71
Connecting a monitor or a TV	72









Editing

Protecting recorded movies and still images (Protect)	75
Dividing a movie	76
Deleting movies and still images	77
Copying movies and still images	78
Capturing still images from a movie	79
Formatting the recording media	80
Preventing data on recording media from being recovered	80
Repairing the image database file	81

Using the Menu

Operating the menu	82
--------------------------	----

Table of Contents (Continued)

Menu items	84
 (CAMERA SET) menu	88
Settings to adjust your camcorder to the recording conditions (GAIN SET/  STEADYSHOT, etc.)	
 (REC/OUT SET) menu	92
Recording settings, input and output settings (REC SET/VIDEO OUT)	
 (AUDIO SET) menu	94
Settings for the audio recording ( AUDIO FORMAT/XLR SET, etc.)	
 (DISPLAY SET) menu	95
Display settings (MARKER/DISPLAY OUTPUT, etc.)	
 (TC/UB SET) menu	99
Time code settings (TC PRESET/UB PRESET/TC FORMAT, etc.)	
 (OTHERS) menu	101
Settings while recording or other basic settings (AREA SET/BEEP, etc.)	

Connecting with another device

Saving images on an external media device	104
Creating a standard definition image quality (SD) disc with a recorder, etc.	106
Saving images with a computer	107

Troubleshooting

Troubleshooting	109
Warning indicators and messages	117

Additional Information

Recording time of movies and the number of recordable photos	119
Using your camcorder abroad	121
File/folder structure on the memory card and the flash memory unit ...	122
Maintenance and precautions	123
About the AVCHD format	123
About the memory card.....	123
About the "InfoLITHIUM" battery pack.....	124
About handling of your camcorder	126
Specifications	129
Index	134

Step 1: Checking supplied items

Make sure that you have following items supplied with your camcorder. The number in the parentheses indicates the number of that item supplied.

AC Adaptor (AC-PW10) (1) (p. 20)



Charger (AC-VL1) (1) (p. 19)

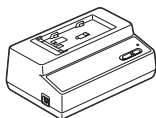

Power cord (mains lead) (2) (p. 19)



Rechargeable battery pack (NP-F770) (1) (p. 19, 124)

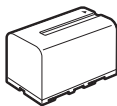

Wireless Remote Commander (RMT-845) (1) (p. 11)

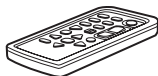

A button-type lithium battery is already installed.

Component video cable (1) (p. 72)

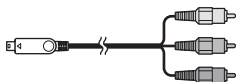

A/V connecting cable (1) (p. 72, 106)



USB cable (1) (p. 104, 107)



USB Adaptor Cable (1) (p. 104)



Large LCD viewfinder (1) (p. 30)

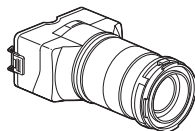

Large eyecup (1) (p. 30)



Wind Screen (1), Microphone (ECM-XM1) (1) (p. 26)

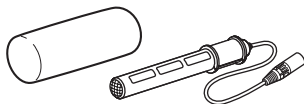

Grip (1) (p. 27)

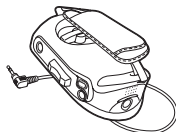

Flash memory unit jack cover (1) (p. 32)

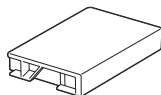

Step 1: Checking supplied items (Continued)

Body cap (attached to the camcorder) (1)
(p. 21)



Cable stopper (1) (p. 7)

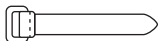

Handle (1) (attached to the camcorder)
(p. 25)

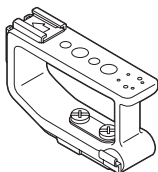

Microphone holder (1) (p. 26)

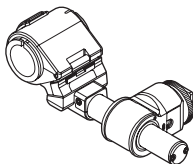

CD-ROM "Content Management Utility" (1)

CD-ROM "Manuals for Interchangeable
Lens Digital HD Video Camera Recorder"
(1)

Operating Guide (2)

**Only for NEX-FS700UK/FS700EK/
FS700K**

Zoom lens (E 18-200mm F3.5-6.3 OSS)
(1) (p. 21)



Lens hood (1) (p. 23)



Front lens cap (1), rear lens cap (1)
(attached to the lens) (p. 21)

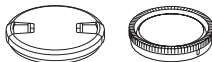

Step 2: Charging the battery pack

You can charge the “InfoLITHIUM” battery pack (L series) with the supplied Charger.

Notes

- You can use a large capacity battery pack, NP-F770 (supplied) or NP-F970 (sold separately), with your camcorder. You cannot use NP-F570.

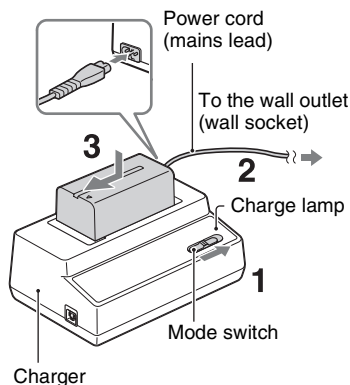

1 Set the mode switch to CHARGE.

2 Connect the power cord (mains lead) to the Charger and the wall outlet (wall socket).

3 Place the battery pack in the slot of the Charger, press it down, and slide it in the direction of the arrow.

The charge lamp turns on and charging starts.

After charging the battery

The charge lamp turns off (normal charge). If you continue charging 1 more hour after the charge lamp turns off, you can use the battery a little longer (full charge). Remove the battery pack from the Charger when the charge is completed.

To attach the battery pack

Press the battery pack against the back of your camcorder and slide it in the direction of the arrow.

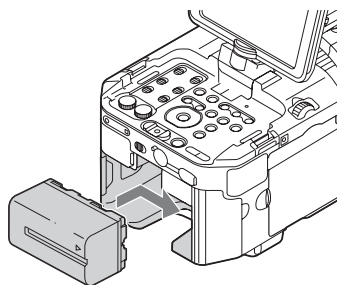

Tips

- You can check the remaining battery life with the status check function (p. 71).

Step 2: Charging the battery pack (Continued)

To remove the battery pack

Slide the POWER switch to OFF. Push the BATT RELEASE (battery release) button and slide the battery pack in the direction of the arrow.

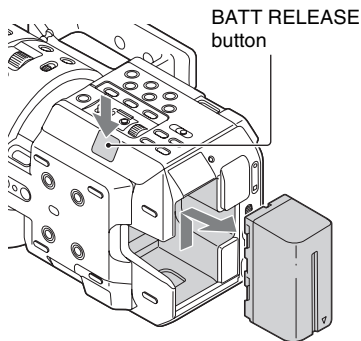

To store the battery pack

If the battery pack is not in use for a while, run down the battery and store it (p. 125).

Charging time

Approximate time (minute) required when you charge a fully discharged battery pack.

Battery pack	Normal charge time	Full charge time
NP-F770	250	310
NP-F970	365	425

⚡ Notes

- The supplied battery pack is NP-F770.
- You cannot use the NP-F570 battery pack with your camcorder.

On the battery pack

- Before changing the battery pack, slide the POWER switch to OFF.
- The Battery Info (p. 71) will not be correctly displayed under the following conditions.
 - The battery pack is not attached correctly.
 - The battery pack is damaged.
 - The battery pack is worn-out.

Using an outside power source

By using the supplied AC Adaptor, you can use the camcorder on AC power (house current), without worrying about running out of power.

Connect the AC Adaptor and the power cord (mains lead) to the DC IN jack of your camcorder and the wall outlet (wall socket).

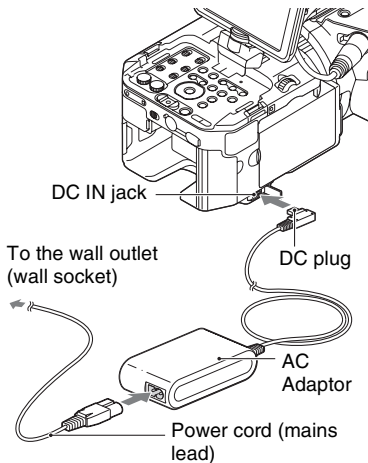

⚡ Notes

- You cannot use the connecting cord DK-415, DK-215 with your camcorder.

On the AC Adaptor/Charger

- Use the nearby wall outlet (wall socket) when using the AC Adaptor/Charger. Disconnect the AC Adaptor/Charger from the wall outlet (wall socket) immediately if any malfunction occurs while using your camcorder.
- Do not use the AC Adaptor/Charger placed in a narrow space, such as between a wall and furniture.
- Do not short-circuit the DC plug of the AC Adaptor/Charger or battery terminal with any metallic objects. This may cause a malfunction.

Step 3: Attaching the lens

This manual explains how to attach a lens using the E 18-200mm F3.5-6.3 OSS lens that comes with NEX-FS700UK/FS700EK/FS700K.

Hold the camcorder body with the front end downward, and quickly change the lens somewhere away from dusty locations so as to keep dust or debris from getting inside the camcorder body.

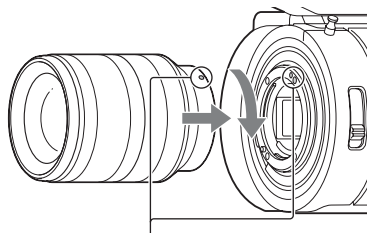

Mounting indexes (white)

- 1 Remove the body cap from the camcorder body and the rear lens cap from the lens.**

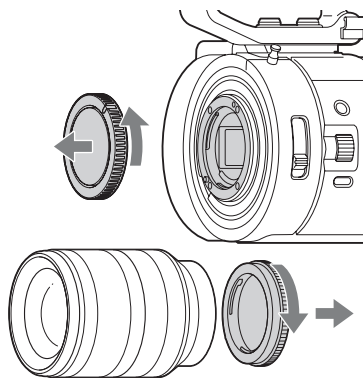

- 2 Mount the lens by aligning the mounting indexes (white) on the lens and the camcorder body. While pushing the lens lightly toward the camcorder body, turn the lens clockwise.**

The lens is mounted when it clicks into the locked position.

Notes

- When attaching a lens, do not press the lens release button.
- Attach the lens to the camcorder squarely, without excessive force. Mounting the lens forcibly may result in a malfunction or damage of the lens mount and ND filter.
- There may be a gap between the lens and the lens mount, depending on the lens attached. This is normal.

Tips

- When you have changed the lens, it is recommended to adjust the black balance (p. 48) before recording. When you adjust the black balance, make sure that the front lens cap is attached.

Step 3: Attaching the lens (Continued)

Removing the lens

- 1 While pressing the lens release button all the way in, turn the lens counterclockwise until it stops.**

When you remove the lens, make sure that you hold both of the lens and the camcorder body.

Lens release button

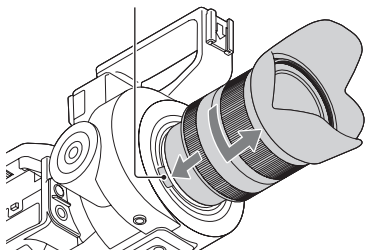

- 2 Replace the rear lens cap on the lens and attach the body cap to the camcorder body.**

Align the mark on the body cap to the mounting index, and turn the cap clockwise.

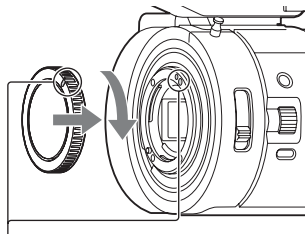

Align the marks.

Before you attach caps, remove dust from them.

Notes

- When changing the lens, if dust or debris adheres to the glass surface of the mount, it may appear on the image, depending on the shooting conditions. The glass surface of the mount has an anti-dust coating, to prevent dust from adhering to the image sensor. However, attach or remove the lens quickly somewhere away from dusty locations.
- Do not leave the camcorder body with the lens and body cap removed.

If dust or debris adheres on the glass surface of the mount

Turn off the camcorder and detach the lens. Clean the glass surface of the mount and the surrounding area using a blower (sold separately), and then reattach the lens.

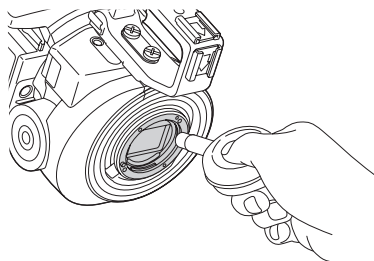

Notes

- Do not use a spray blower because it may scatter water droplets inside the camcorder body.
- Hold the camcorder's face downward to prevent the dust from resettling in the camcorder.
- If you cannot clean the glass surface of the mount by the above procedure, consult your Sony dealer or local authorized Sony service facility.

To attach the lens hood

Align the red line of the lens hood to that of the lens and mount the lens hood on the lens. Turn the lens hood clockwise until the red dot of the lens hood and the red line of the lens align with a click.

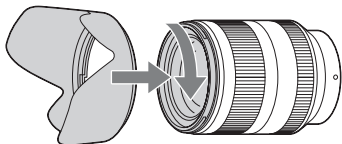

When storing the lens, fit the lens hood onto the lens backwards.

Mount adaptor

Using a mount adaptor (sold separately), you can attach an A-mount lens (sold separately) to your camcorder. For details, refer to the operating instructions supplied with the mount adaptor.

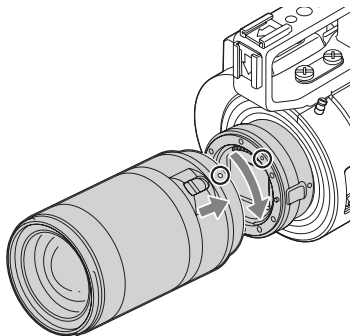
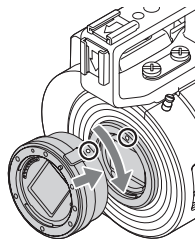

The available functions differ depending on the mount adaptor type.

LA-EA1

Functions	
Autofocus	Available in photo mode with SAM/SSM lens only*
AF system	Contrast AF
AF/MF Select	Switchable on the lens

Step 3: Attaching the lens (Continued)

LA-EA2

Functions	
Autofocus	Movie: Continuous Photo: Single
AF system	Phase-detection AF
AF/MF Select	SAM: switchable on the lens SSM: must be switched on the lens and with the FOCUS switch of the camcorder Other lenses: switchable with the FOCUS switch of the camcorder

* With LA-EA1, autofocus speed with an A-mount lens attached will be slower compared to an E-mount lens. (When an A-mount lens is attached, the autofocus speed will be about 2 seconds to 7 seconds, when shooting under Sony measurement condition. The speed may vary depending on the subject, ambient light, etc.)

Operations when using LA-EA2

- Aperture is set to F3.5 when you record movies with autofocus. When you are using a lens with an F3.5 or smaller F-stop, aperture is set to the maximum F-stop of the lens. When you want to set your own value for aperture, select manual focusing. Adjusting the aperture during recording may cause the noise or turn the LCD screen brighter.
- The iris will not adjust automatically in movie mode.

Notes

- Some lenses may not be usable or may have limited functionality. Check the dedicated support web site or consult your local authorized Sony service facility on compatible lenses.
- The sound of the lens and the camcorder in operation may be recorded during movie recording. You can avoid this by recording without the microphone, or by setting the CH1 (AUTO/MAN) switch or CH2 (AUTO/MAN) switch to MAN and the AUDIO LEVEL dial to 0 (p. 53).

- It may take a long time or may be difficult for the camcorder to focus, depending on the lens used or the subject.

AF area display

When using an A-mount lens with a mount adaptor, the camcorder displays in-focus frames.

Autofocusing: The frame of the area that is in focus turns green.

Manual focusing: The frame of the area that is in focus turns green. This can assist focusing.

When using the LA-EA1 (only in photo mode)

Displays only when autofocus

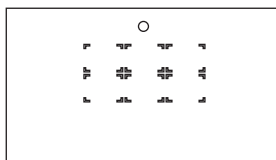

When using the LA-EA2

Autofocusing

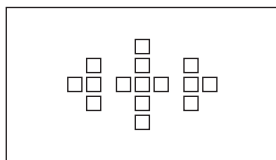

Manual focusing



Notes

- AF area is not displayed during Super Slow Motion recording.

Step 4: Attaching the handle, microphone and grip

Attaching the handle

The handle is attached to the camcorder at the factory.

- 1 Slide the handle into the accessory shoe in the direction of the arrow.

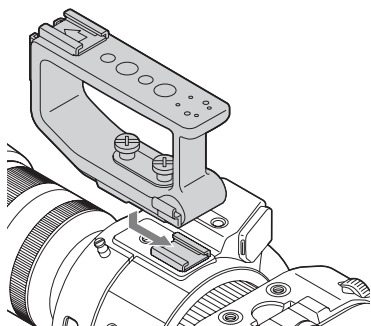

- 2 While pressing the screw down, turn it clockwise to fasten the handle.

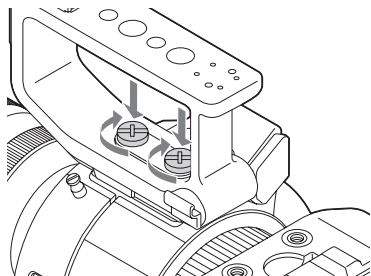

Removing the handle

Remove the handle using the reversed procedure for attaching.

💡 Tips

- The screw holes of the handle are for 1/4-20UNC screws (22 mm in length).

To attach an accessory without using the handle

Remove the handle, and fully insert the accessory shoe plate (p. 26) in the direction of the arrow.

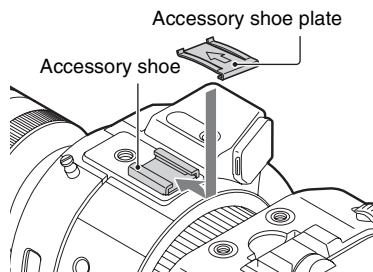

Step 4: Attaching the handle, microphone and grip (Continued)

Attaching the microphone

Attach the microphone holder to the handle.

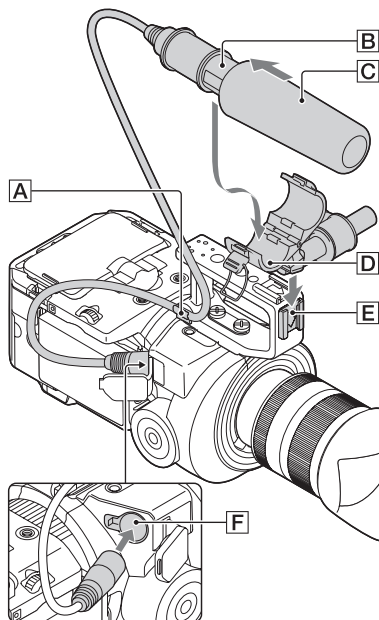

- 1** Attach the microphone holder **D** to the accessory shoe **E** of the handle, then secure with the screw of the microphone holder.
- 2** Attach the wind screen **C** to the supplied microphone **B**.
- 3** Place the microphone **B** in the microphone holder **D** with the model name facing upward, close the cover, and shut the clamp.

- 4** Connect the plug of the microphone to the **INPUT 2** jack **F**.

Put the microphone cable into the cable clamp **A**.

If the light to the lens is blocked

Certain types of microphone may block the light to the lens. If this happens, change the position of the accessory shoe and the microphone holder.

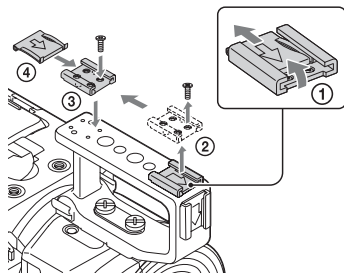

- 1** Lift the edge of the accessory shoe plate at the front of the handle and pull it in the direction opposite to that of the arrow on the accessory shoe plate and remove it from the accessory shoe.
- 2** Remove the 4 screws from the accessory shoe at the front of the handle.
- 3** Place the accessory shoe so its protrusions align with the recesses of the accessory shoe mount at the back of the handle, then fix it to the mount with the 4 screws.
- 4** Insert the accessory shoe plate in the direction of the arrow on the plate surface until the end of the plate engages the end of the shoe.

- ⑤ Attach the microphone holder to the accessory shoe that has been moved to the back of the handle.

Attaching the grip

You can rotate the grip to suit shooting angles.

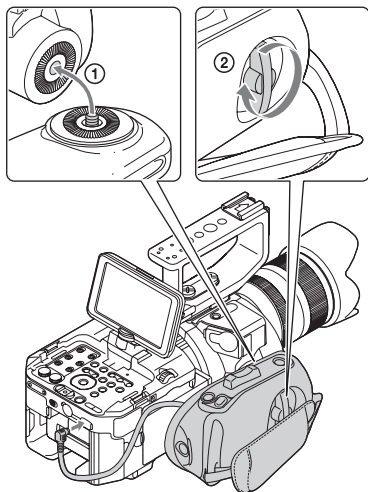

- 1** Align the metal edge of the camcorder body ① and the metal edge of the grip. Choose the grip angle, and fasten the grip securely by pushing and turning the knob ② clockwise.

- 2** Connect the cable to the REMOTE jack.

Grip buttons

The grip has the following buttons.

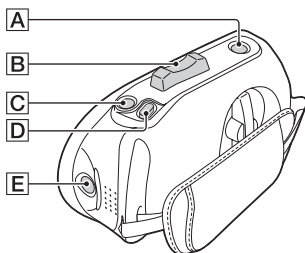

- A** IRIS PUSH AUTO button (p. 43)
B Zoom lever (This is for future function enhancement, and not available at time of purchase.)
C PHOTO button (p. 33)
D EXPANDED FOCUS button (p. 38)
E START/STOP button (p. 33)

When changing the grip angle

Unfasten the knob, adjust the angle, then tighten the knob.

Step 5: Turning on the camcorder and setting the date and time

Turning on the camcorder

Slide the **POWER** switch to **ON** while pressing the green button.

When you use your camcorder for the first time, the [CLOCK SET] screen appears.

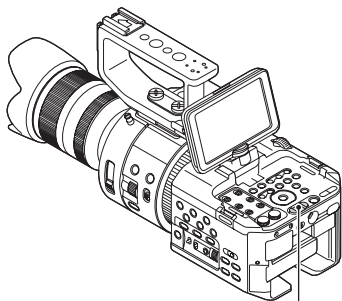

Press and hold the green button.

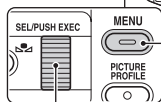
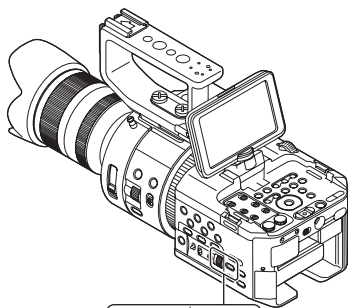
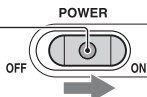

SEL/PUSH EXEC dial

MENU button dial

When you set the date and time again, press the MENU button, and select  (OTHERS) → [CLOCK SET].

To turn off the power

Slide the POWER switch to OFF.

Notes

- If warning messages appear on the LCD screen, follow the instructions.

Setting the date and time

Set the date and time when you use your camcorder for the first time.

Tips

- If you do not use your camcorder for **about 3 months**, the built-in rechargeable battery gets discharged and the date and time settings may be cleared from the memory. In that case, charge the rechargeable battery and then set the date and time again (p. 128).

- 1 Select your area by turning the SEL/PUSH EXEC dial, then press the dial.

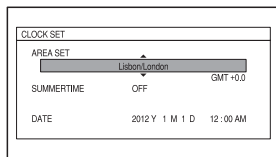

Step 6: Adjusting the LCD screen

- 2** Set [SUMMERTIME], [Y] (year), [M] (month), [D] (day), hour and minute, by turning the SEL/PUSH EXEC dial, then press the dial.



The clock starts.

- Set [SUMMERTIME] to [ON] to move the time forward 1 hour.
- You can set any year up to the year 2037.
- Midnight is indicated as 12:00 AM, and noon as 12:00 PM.

Tips

- The date and time are automatically recorded on the selected recording media, and can be displayed during playback (DATA CODE button, p. 70).

Changing the language setting

You can change the on-screen displays to show messages in a specified language. Press the MENU button and select (OTHERS) with the SEL/PUSH EXEC dial. Select the screen language in [LANGUAGE] (p. 102).

Setting [60i/50i SEL]

In the default setting, [60i/50i SEL] is set as follows:

NEX-FS700U/FS700UK: [60i]

NEX-FS700E/FS700EK/FS700/FS700K: [50i]

To change the setting, press the MENU button and select (OTHERS) → [60i/50i SEL] with the SEL/PUSH EXEC dial (p. 103).

Using the LCD screen

The LCD panel is placed above the centerline of the lens, on the same angle as the lens views the subject, so the subject will be captured as you see it.

The LCD screen can be rotated right or left, allowing a person other than the camera operator to see the image.

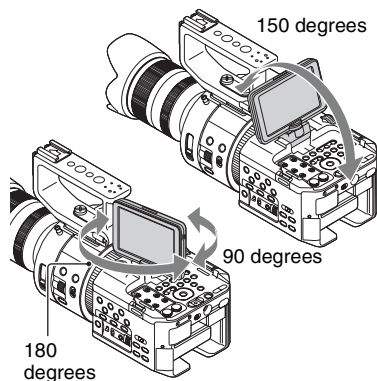

To set and hold the LCD screen angle

Turn the LCD HOLD dial, and set. Turn the LCD HOLD dial in the opposite direction to loosen when you change the angle.

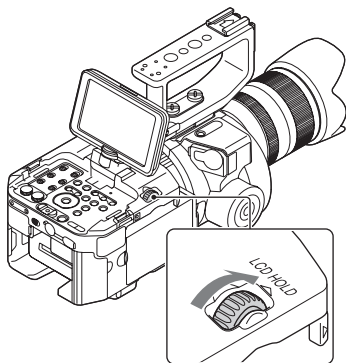

Step 6: Adjusting the LCD screen (Continued)

Using the LCD screen with the large LCD viewfinder attached

You can use the LCD screen as a viewfinder by attaching the large LCD viewfinder to the LCD screen.

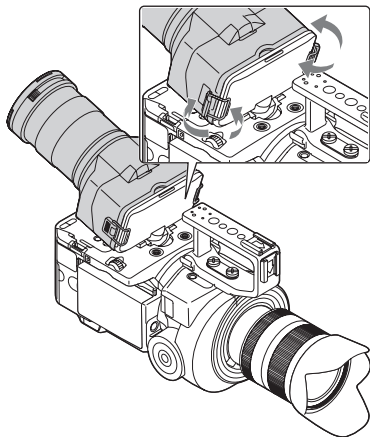

Using the viewfinder with different recording styles

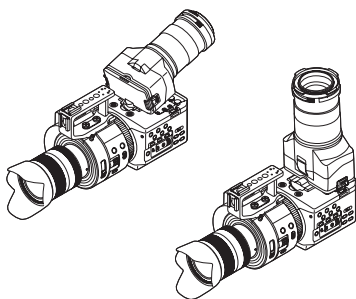

Adjusting the viewfinder lens

Turn the viewfinder lens adjustment ring so that you can see the image in the viewfinder clearly.

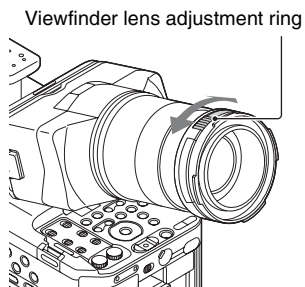

When the picture in the viewfinder is hard to see

If you cannot see the picture in the viewfinder clearly under bright circumstances, use the supplied large eyecup. To attach the large eyecup, stretch it slightly and align it with the groove in the large LCD viewfinder. You can attach the large eyecup facing either the right or left side.

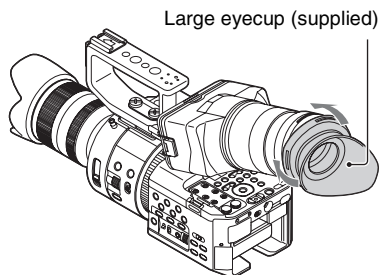

💡 Tips

- If you are farsighted and have a trouble seeing images in the viewfinder, you can attach a 52 mm close-up lens (sold separately) to the viewfinder lens adjustment ring.

Step 7: Preparing the recording media

Memory card

Types of memory cards you can use in your camcorder

SD Speed Class	
“Memory Stick PRO Duo” media (Mark2)*	-
“Memory Stick PRO-HG Duo” media*	-
SD memory card**	-
SDHC memory card**	Class 4 or faster
SDXC memory card**	-

Types of memory cards you can use with Slow & Quick Motion recording and Super Slow Motion recording

SD Speed Class	
“Memory Stick PRO-HG Duo” media*	-
SD memory card**	-
SDHC memory card**	Class 10 or faster
SDXC memory card**	-

* Described as “Memory Stick PRO Duo” media in this manual.

**Described as SD card in this manual.

⚙ Notes

- Operation with all memory cards is not assured.
- “Memory Stick PRO Duo” media, half the size of “Memory Stick” media, or standard size SD cards can be used for this camcorder.
- Do not attach a label or the like on memory card or memory card adaptor. Doing so may cause a malfunction.
- “Memory Stick PRO Duo” media of up to 32 GB and SD cards of up to 64 GB have been verified to operate with your camcorder.
- See page 119 for the recordable time of memory cards.
- A MultiMedia Card cannot be used with this camcorder.

- Movies recorded on SDXC memory cards cannot be imported to or played back on computers or A/V devices not supporting the exFAT file system, that is used for SDXC memory cards, by connecting the camcorder to these devices with the USB cable. Confirm in advance that the connecting equipment is supporting the exFAT file system. If you connect equipment not supporting the exFAT file system and the format screen appears, do not perform the format. All the data recorded will be lost.

Open the cover, and insert the memory card with the notched edge in the direction as illustrated until it clicks.

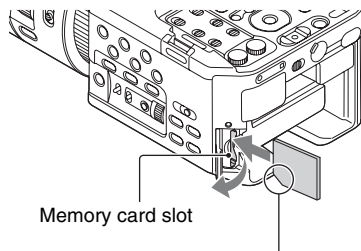

Note the direction of the notched corner.

- If you insert a memory card into the slot in the wrong direction, the memory card, the memory card slot, or image data may be damaged.

To eject the memory card

Lightly push the memory card once.

⚙ Notes

- If [The image database file is corrupted. The media must be restored to use again.] appears, format the memory card (p. 80).
- When inserting or ejecting the memory card, be careful of the memory card popping out and dropping.

Step 7: Preparing the recording media (Continued)

Flash memory unit

You can attach a flash memory unit HXR-FMU128 (sold separately) to your camcorder for recording movies.

While sliding the **RELEASE** lever, align the mark on the camcorder with the one on the flash memory unit, and slide the flash memory unit in the direction of the arrow.

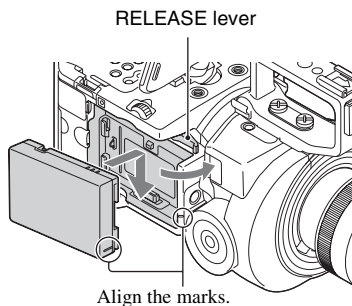

To remove the flash memory unit

Turn off the power, then while sliding the **RELEASE** lever, remove the flash memory unit in the direction of the arrow.

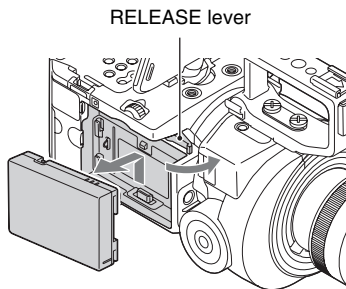

When you do not use a flash memory unit

Leave the flash memory unit jack cover attached.

Tips

- Your camcorder does not have the relay recording function. If the memory card is fully recorded during recording, the camcorder stops recording automatically.
- You can record movies on both of the memory card and the flash memory unit simultaneously (p. 34).

Recording

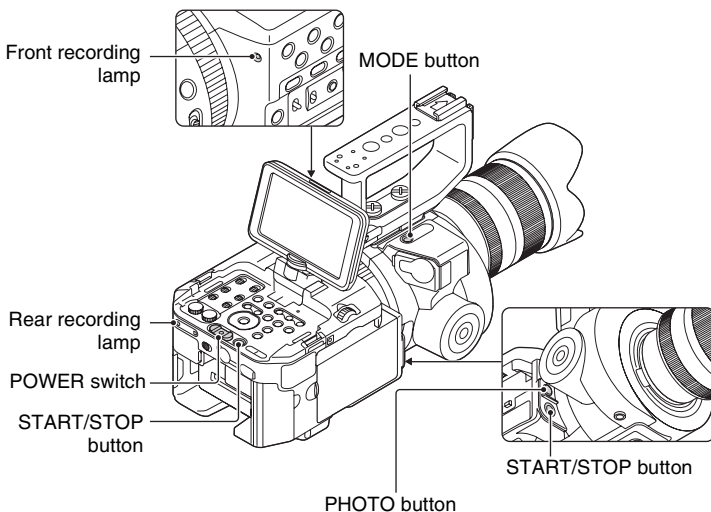

Recording movies

Your camcorder records movies on a memory card and/or a flash memory unit. The factory setting of recording movies is high definition image quality (HD). Do the following steps to record movies.

- 1 Slide the POWER switch to ON while pressing the green button.

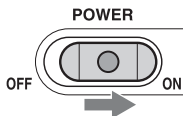

- 2 Make sure that the  (Movie) lamp is lit.



3 Press the START/STOP button.

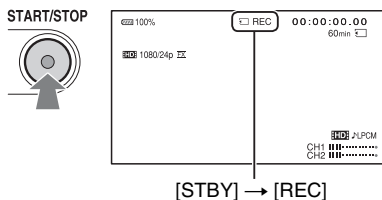

The recording lamp lights up during recording.

To stop the movie recording, press the START/STOP button again.

Notes

- When the access lamp is lit or flashing in red, your camcorder is reading or writing data on recording media. Do not shake or apply strong force to your camcorder, do not turn the power off, and do not remove the recording media, battery pack or the AC Adaptor. The image data may be destroyed.
- See page 119 on the recording time of movies.
- Your camcorder can record a movie for about 13 hours continuously.
- If a movie file exceeds 2 GB during recording, the camcorder divides the file and create a new file automatically.
- The menu settings, the PICTURE PROFILE settings, and the settings made by the AUTO/MANUAL switch are stored in your camcorder when you slide the POWER switch to OFF. The access lamp lights up while the settings are being stored. If you remove the battery pack or the AC Adaptor before turning off the power, the settings may return to the default settings.

Tips

- When recording in high definition image quality (HD), the aspect ratio is fixed to 16:9. When recording in standard definition image quality (SD), you can switch the aspect ratio to 4:3 ([**SD**] WIDE REC), p. 92).
- You can change the screen display during recording (p. 70).
- Indicators displayed on the LCD screen during recording are shown on page 12.
- The recording lamp can be set to stay off ([REC LAMP[F]], [REC LAMP[R]], p. 102).
- You can capture still images from the movies you recorded (p. 79).

To record movies using both the memory card and the flash memory unit (Simultaneous recording)

You can record movies on both of these recording media simultaneously.

Press MENU → select **REC/OUT SET** → [REC SET] → [**HD**] SIMULTANEOUS REC → [ON] (default setting) with the SEL/PUSH EXEC dial.

Tips

- Set [**HD**]/**SD** SET to [**HD**] (p. 43) for the simultaneous recording.
- If one of the recording media is unable to continue recording during simultaneous recording, the other recording media continues recording without pause.

- When [HD] SIMULTANEOUS REC is [ON], movies are recorded on both media, irrespective of the [MEDIA SELECT] setting.

To record movies only on the memory card or the flash memory unit

- ① Press MENU → select (REC/OUT SET) → [REC SET] → [HD] SIMULTANEOUS REC → [OFF] with the SEL/PUSH EXEC dial.
- ② Select (REC/OUT SET) → [MEDIA SELECT] → [MEMORY CARD] or [FMU] (flash memory unit).

💡 Tips

- A message appears if an access error occurred while the camcorder was accessing the recording media.

Recording still images

- 1 Press the MODE button to turn on the (Photo) lamp.



- 2 Press the PHOTO button lightly to adjust the focus, then press it fully.



Focus indicator when autofocus

The focus indicator shows the focusing status by lighting/flashing.

- lit : Focus locked.
- flashing: The camcorder cannot focus on the subject automatically. Either recompose the shot or change the focus setting.

💡 Tips

- You cannot record still images while (Movie) lamp is lit.
- See page 120 on the expected number of recordable photos.
- This camcorder uses a rolling shutter for still image recording, which can result in subject distortion, flicker, or change the contrast when using the flash, depending on the shooting conditions.

Zooming

Turn the zooming ring right or left to decide on the size of the subject in your image. Zooming must be done before focusing.

Notes

- The available operations and operating methods depend on the lens attached. Refer to the operating manuals that come with your lens.
- Do not grab or apply a strong force to the lens cylinder that rolls out when zooming. The lens may be damaged.

Tips

- You can change the zoom indicator (p. 98).

Adjusting the focus

You can adjust the focus manually for different recording conditions. Use this function in the following cases.

- To record a subject behind a window covered with raindrops.
- To record horizontal stripes.
- To record a subject with little contrast between the subject and its background.
- When you want to focus on a subject in the background.

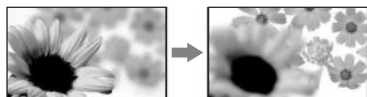

- To record a stationary subject using a tripod.

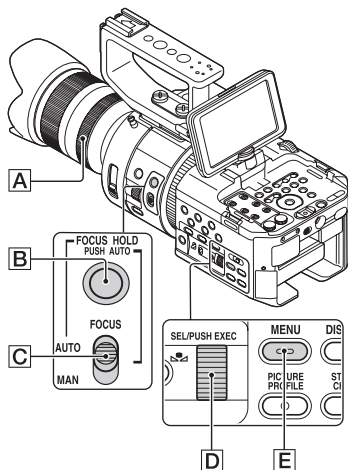

Notes

- The following functions and buttons may not be available, depending on the combination of the mount adaptor and A-mount lens (sold separately).
 - Button **B**
 - FOCUS switch **C** at the AUTO position

1 During recording or standby, set the FOCUS switch **C** to MAN.

appears.

2 Rotate the focusing ring **A** and adjust the focus.

changes to when the focus cannot be adjusted any farther. changes to when the focus cannot be adjusted any closer.

To restore automatic adjustment

Set the FOCUS switch **C** to AUTO. disappears and the automatic focus adjustment is restored.

💡 Tips

- The focal length information (for when it is dark and hard to adjust the focus) appears for about 3 seconds in the following cases.
 - When you set the FOCUS switch **C** to MAN and appears on the LCD screen.
 - When you rotate the focusing ring **A** while is displayed on the LCD screen.
- You can switch the focal length information between meters and feet ([FOCUS DISPLAY], p. 98).

Adjusting the focus (Continued)

To measure the precise recording distance

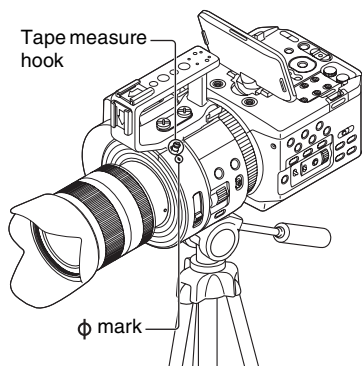

The φ mark and tape measure hook are on a plane with the image sensor. To measure the precise distance between the camcorder and the subject, use this mark or tape measure hook as a reference.

You can attach the end of a tape measure to the hook, and measure the distance from the subject.

Notes

- You cannot focus on a subject closer to the lens than the minimum focus of the lens used. Make sure you are not too close to the subject.

Using automatic focus/fixed focus temporarily (Push auto focus/Focus hold)

Push auto focus

Set the FOCUS switch [C] to MAN, then press and hold the FOCUS HOLD/PUSH AUTO button [B]. The image is shot with automatic focus. Keep the button pressed to shoot. If you release the button, the setting returns to manual focusing.

Focus hold

Set the FOCUS switch [C] to AUTO, then press and hold the FOCUS HOLD/PUSH AUTO button [B]. The image is shot with the focus fixed at the point you start to press the FOCUS HOLD/PUSH AUTO button. Keep the button pressed to shoot. If you release the button, the setting returns to auto focusing.

Notes

- If the lens has the same function button as your camcorder, the function on the lens works the same as your camcorder. For example, when focus hold is active on your camcorder, the button on the lens functions as focus hold.

Using the expanded focus (Expanded focus)

The selected area on the LCD screen is magnified and displayed. It is easier to confirm the focus setting during manual focusing.

Press the EXPANDED FOCUS button on the grip (p. 27).

The setting changes with each press of the button.

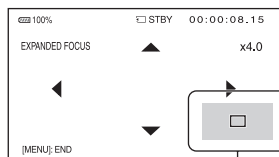

Enlarged display position

You can adjust the enlarged display position with the $\uparrow/\downarrow/\leftarrow/\rightarrow$ button on the camcorder. Press the EXEC button to set the enlarged display position back to the center.

Notes

- Even though the image appears expanded on the LCD screen, the recorded image is not expanded.

Tips

- You can change the magnification ratio with [EXPANDED FOCUS MAG] (p. 97).
- You can assign this function to an ASSIGN button (p. 64).

Focusing by touching the LCD screen (Spot focus)

You can focus on the point where you touch on the LCD screen.

1 Press the MENU button [E].

2 Select [CAMERA SET] → [SPOT FOCUS] with the SEL/PUSH EXEC dial [D].

3 Touch the point to be focused on the LCD screen.

Notes

- [SPOT FOCUS] is available only when the FOCUS switch [C] is set to MAN.

Tips

- You can assign this function to an ASSIGN button (p. 64).

To cancel the spot focus

Press the MENU button [E].

Focusing on a detected face (Face detection)

The camcorder detects the face and focuses on it (The default setting is [OFF]). You can use this function when the FOCUS switch [C] is set to AUTO.

1 Press the MENU button [E].

2 Select [CAMERA SET] → [FACE DETECTION] → [ON] with the SEL/PUSH EXEC dial [D].

Faces are detected.

When the faces are detected, frames appear on the LCD screen.

3 Move the selection cursor (orange colored frame), and select the priority face with the SEL/PUSH EXEC dial [D], then press the dial.

Selection cursor
(orange colored frame)



Priority face frame
(double frame)

The frame on the priority face changes to a double frame.

To cancel face detection

Move the selection cursor (orange colored frame) onto the frame (double frame) on the priority face, using the SEL/PUSH EXEC dial **[D]**, then press the dial.

🔊 Notes

- Faces may not be detected depending on the recording environment, the condition of the subject or the settings.
- You may not be able to get the proper effect in some recording environments. If this happens, set [FACE DETECTION] to [OFF].

💡 Tips

- You can assign this function to an ASSIGN button (p. 64).
- To make it easy to detect faces, record under the following conditions:
 - Record in a moderately bright place
 - Do not obscure the face with a hat, mask, sunglasses, etc.
 - Face the front of the camera
- When [FACE DETECTION] is set to [ON], you cannot adjust shutter speed, etc. To adjust shutter speed, etc., set [FACE DETECTION] to [OFF] temporarily by setting the FOCUS switch **[C]** to MAN.

Using focus transition

When you record movies using an E-mount lens, you can register focal positions in advance, and shift focus smoothly (focus transition) between positions.

For example, you can gradually shift the focus from foreground to background. To prevent camera shake or transition lag between positions, a tripod is recommended.

1 Assign [FOCUS TRANSITION] to an ASSIGN button (p. 64).

Focus transition is assigned to the ASSIGN 4/5/6 buttons at the same time.

The screen changes in the order STORE → CHECK → EXEC → cancel with each press of the ASSIGN 4 button.

2 Register the focal position.

- ① Press the ASSIGN 4 button repeatedly to show the [STORE] screen.
 - ② Adjust the focal position manually.
 - ③ Press the ASSIGN 5 button to register on FOCUS-A, or press the ASSIGN 6 button to register on FOCUS-B.
- During registration and confirmation, the icon of the target focal position flashes. You cannot operate your camcorder when this is flashing.

3 Confirm the registered focal position.

- ① Press the ASSIGN 4 button repeatedly to show the [CHECK] screen.
 - ② Press the ASSIGN 5 button to confirm the setting on FOCUS-A, and press the ASSIGN 6 button to confirm the setting on FOCUS-B. The focal position moves to the position registered in step 2.
- The focus does not shift with the setting made on [TRANSITION TIME] (p. 90) on the confirmation screen.

4 Record with focus transition.

- ① Press the ASSIGN 4 button repeatedly to show the [EXEC] screen.
- ② Press the START/STOP button.
- ③ Press the ASSIGN 5 button to record with FOCUS-A, and press the ASSIGN 6 button to record with FOCUS-B. The focus shifts from the current position to the registered position.

- You can change the transition time to FOCUS-A, or to FOCUS-B ([TRANSITION TIME], p. 90).
- You can set the time to start the transition after pressing the ASSIGN 5 button or the ASSIGN 6 button ([START TIMER], p. 90).
- You can link the time you press the START/STOP button with the time to start recording ([REC LINK], p. 90).

To cancel the focus transition

Press the ASSIGN 4 button repeatedly to cancel, or press the MENU button [E].

Notes

- If you perform focus transition from an arbitrary focal position, it is not possible to return the focus to that position from FOCUS-A or FOCUS-B.
- If you press any of the following buttons or perform any of the following operations during focus transition, focus transition is cancelled.
 - MENU button
 - VISUAL INDEX button
 - EXPANDED FOCUS button
 - S&Q button
 - Any of the ASSIGN button assigned [LAST SCENE REVIEW], [VISUAL INDEX], [SPOT FOCUS] or [EXPANDED FOCUS].
 - Remove the lens.
 - Zoom the lens.
- If you perform any of the following operations, registered focal positions on FOCUS-A and FOCUS-B are reset.
 - Set the POWER switch to OFF.
 - Remove the lens.
 - Zoom the lens.

💡 Tips

- You can shift the focus from FOCUS-A to FOCUS-B-registered positions, or vice versa. For example, to shift from FOCUS-A to FOCUS-B-registered positions, press the ASSIGN 5 button on the confirmation screen to set to FOCUS-A, then press the ASSIGN 6 button on the execution screen.
- If you press the ASSIGN 5 button or the ASSIGN 6 button before pressing the START/STOP button in step 4, you can rehearse the focus transition.

Changing the recording setting/image size

Selecting the recording format for high definition image quality (HD)

You can select the recording format (bit-rate, image size, frame rate, scanning system). The default setting is as follows:
NEX-FS700U/FS700UK: 1080/24p
NEX-FS700E/FS700EK/FS700/FS700K:
 1080/25p

1 Press the MENU button.

2 Select (REC/OUT SET)
[REC SET] [REC FORMAT]
 a desired format with the SEL/
PUSH EXEC dial.

Setting value

60i	50i
1080/60p PS	1080/50p PS
1080/60i FX	1080/50i FX
1080/60i FH	1080/50i FH
1080/60i HQ	1080/50i HQ
1080/60i LP	1080/50i LP
1080/30p FX	1080/25p FX
1080/30p FH	1080/25p FH
1080/24p FX	-
1080/24p FH	-
720/60p FX	720/50p FX
720/60p FH	720/50p FH

- Bit-rate
PS: max. 28 Mbps
FX: max. 24 Mbps
FH: approx. 17 Mbps (average)
HQ: approx. 9 Mbps (average)
LP: approx. 5 Mbps (average)

- Image size
PS: 1,920×1,080
FX: 1,920×1,080/1,280×720
FH: 1,920×1,080/1,280×720
HQ: 1,440×1,080
LP: 1,440×1,080
 - Frame rate
Either 60 or 50 or 30 or 25 or 24
 - Scanning system
i: interlace
p: progressive
- If you select [1080/24p], for example, movies are recorded with following format.
- 1080: Effective scanning lines
 - 24: Frame rate
 - p: Scanning system
 - FX: Recording mode

Frame rate when selecting [60i]

The frame rate displayed on the LCD screen differs from the actual frame rate.

Frame rate on the LCD screen	Actual frame rate
24	23.98
30	29.97
60	59.94

Notes

- The recording mode is fixed to FX or FH with the progressive scanning system.
- Movies recorded with the recording mode set to PS or FX on [REC FORMAT] can be saved on an external media device only (p. 104).

Tips

- The recording format of 480/60i HQ (576/50i HQ) is automatically selected for the standard definition image quality (SD) recording.

Selecting high definition image quality (HD) or standard definition image quality (SD)

You can select the desired image quality from the high definition image quality (HD) or the standard definition image quality (SD) ([**HD**] is the default setting). Change the image quality according to the recording situation or the playback device.

- 1 Press the MENU button.
- 2 Select \leftarrow (REC/OUT SET) \rightarrow [REC SET] \rightarrow [**HD**]/[SD] SET \rightarrow [**HD**] or [SD] with the SEL/PUSH EXEC dial.

Selecting the image size for still images

You can select the image size of the still image. The default setting is [3:2(7.0M)].

- 1 Press the MENU button.
- 2 Select \leftarrow (REC/OUT SET) \rightarrow [IMAGE SIZE] \rightarrow a desired image size with the SEL/PUSH EXEC dial.

Setting value

- ▶ 3:2(7.0M)/16:9(8.3M)

Adjusting the brightness

You can adjust the brightness by controlling the amount of light, etc., using iris, gain, ISO sensitivity, shutter speed or ND filter.

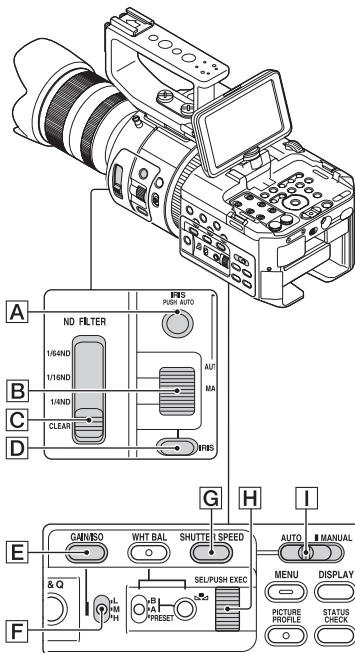

Notes

- When you set the AUTO/MANUAL switch **I** to AUTO, iris, gain, ISO sensitivity, shutter speed and white balance are adjusted automatically. You cannot adjust any of them manually.

Adjusting the iris

This is handy for making the background blurred or sharp.

- 1 Set the AUTO/MANUAL switch **I** to MANUAL.

2 Press the IRIS button **[D]**.

[A] next to the iris value disappears.

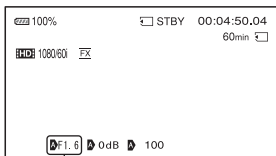

Iris value

3 Adjust the iris with the iris ring **[B]**.

The volume of the light increases the more that you open the aperture (decreasing F value). The volume of the light decreases the more that you close the aperture (increasing F value).

To temporarily adjust the iris automatically

Hold the IRIS PUSH AUTO button **[A]** down.

The iris is adjusted automatically for as long as you hold the button down

To adjust the iris automatically

Press the IRIS button **[D]**.

[A] appears next to the iris value.

Notes

- You can make this adjustment only with an E-mount lens.
- In movie mode when using A-mount lenses (sold separately), you must adjust the iris manually, using the iris ring **[B]**. However, IRIS PUSH AUTO button **[A]** is available in the following situations:
 - When using an A-mount lens with the LA-EA2
 - When manually focusing

Tips

- The range of focus, an important effect of the aperture, is called the depth of field. The depth of field gets shallower as the aperture is opened, and deeper as the aperture is closed. Use the aperture creatively to obtain the desired effect in your photography.

Adjusting the gain/ISO sensitivity

You can use this if you do not want to increase the value by AGC (automatic gain control) or the automatic ISO sensitivity adjustment.

Gain and ISO sensitivity are set separately.

1 Set the AUTO/MANUAL switch **[I]** to MANUAL.

2 Press the GAIN/ISO button **[E]**.

[A] next to the gain value or ISO value disappears, or the gain value or ISO value appears on the LCD screen.

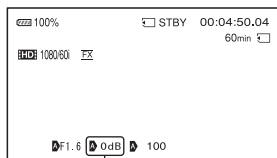

Gain/ISO value

3 Set the gain/ISO switch **[F]** to H, M or L.

The gain value or ISO value set for the selected gain/ISO switch position appears on the LCD screen. You can set the gain value or ISO value for each gain/ISO switch position from [GAIN SET] or [ISO SET] of the **[CAMERA SET]** menu (p. 88).

To adjust the gain automatically

Press the GAIN/ISO button **[E]**. The gain value or ISO value disappears, or **[A]** appears next to the gain value or ISO value.

[Lightbulb] Tips

- You can switch the displayed value between gain and ISO sensitivity, with [GAIN/ISO SEL] in movie shooting mode. Note that gain and ISO sensitivity are separately saved with different values (p. 88).

Adjusting the shutter speed

You can adjust and fix the shutter speed manually. You can make a moving subject look still or emphasize the movement of a moving subject by adjusting the shutter speed.

1 Set the AUTO/MANUAL switch **[I]** to MANUAL.

2 Press the SHUTTER SPEED button **[G]** to highlight the shutter speed value.

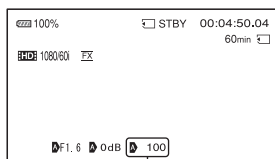

Shutter speed value

3 Change the shutter speed displayed on the LCD screen by turning the SEL/PUSH EXEC dial **[H]**.

The following shutter speed adjustment ranges are available:

- Movie mode
 - When selecting [60i]: 1/4 - 1/10000 (1/3 - 1/10000 when shooting with 24p)
 - When selecting [50i]: 1/3 - 1/10000
- Photo mode
 - 1/4 - 1/4000

The denominator of the set shutter speed appears on the LCD screen. For example, [100] appears on the LCD screen when you set the shutter speed to 1/100 second. The larger the value on the LCD screen is, the faster the shutter speed is.

4 Press the SEL/PUSH EXEC dial **[H]** to lock the shutter speed.

To readjust the shutter speed, repeat steps from 2.

Adjusting the brightness (Continued)

Tips

- It is difficult to focus automatically at a lower shutter speed. Manual focusing with your camcorder attached to a tripod is recommended.
- When recording under fluorescent lamps, sodium lamps, or mercury lamps, the picture may flicker or change colors, or may have horizontal bands of noise. You may be able to improve the situation by adjusting the shutter speed.
- You can switch the shutter speed display between seconds and degrees ([SHUTTER DISPLAY], p. 98).

To adjust the shutter speed automatically

Press the SHUTTER SPEED button  twice.

The shutter speed value disappears, or  appears next to the shutter speed value.

Setting value when switching [60i/50i SEL]

The shutter speed of the same level before changing the [60i/50i SEL] setting is applied. See the following table for the shutter speeds on each level. Shutter speed for still images is not affected.

Level	60i/60p/30p	24p	50i/50p/25p
0	-	3	-
1	4	6	3
2	8	12	6
3	15	24	12
4	30	40	25
5	60	48	50
6	90	50	60
7	100	60	100
8	125	96	120
9	180	100	150
10	250	120	215
11	350	144	300
12	500	192	425
13	725	200	600



Level	60i/60p/30p	24p	50i/50p/25p
14	1000	288	1000
15	1500	400	1250
16	2000	576	1750
17	3000	1200	2500
18	4000	2400	3500
19	6000	4800	6000
20	10000	10000	10000

To adjust the amount of light (ND filter)

If recording conditions are too bright, you can use ND filter to capture a subject more clearly.

Set the ND FILTER switch . 1/4ND is set to decrease the amount of light to approximately 1/4, 1/16ND is to approximately 1/16 and 1/64ND is to approximately 1/64.

Notes

- If you switch ND FILTER switch  during recording, the image or sound may be distorted.
- When the position of the ND FILTER switch  (CLEAR, 1/4ND, 1/16ND, 1/64ND) is not detected, **ND** flashes on the LCD screen. Make sure the ND FILTER switch is set to the correct position.

Tips

- When shooting a bright subject, diffraction - a common phenomenon in video cameras, caused by closing the iris too much - may result in poor focusing. Using ND FILTER switch  suppresses this phenomenon for better shooting images.

Adjusting the color tone

Adjusting the white balance

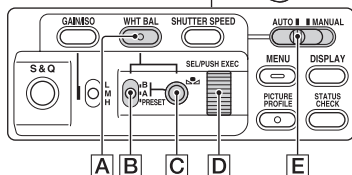
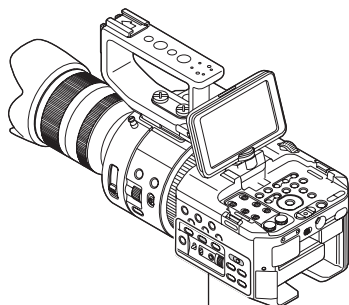

You can adjust and fix the white balance according to the lighting conditions of recording environment.

You can store white balance values in memory A (☀️ A) and memory B (🌃 B), respectively. Unless a white balance is readjusted, values will remain even after the power has been turned off.

When you select PRESET, [OUTDOOR], [INDOOR] or [MANU WB TEMP] is selected, according to which one you previously set with [WB PRESET] in the 📷 (CAMERA SET) menu.

💡 Tips

- You can assign [WB PRESET] to an ASSIGN button (p. 64).

1 Set the AUTO/MANUAL switch **[E]** to MANUAL.

2 Press the WHT BAL button **[A]**.

3 Set the white balance memory switch **[B]** to any one of PRESET/A/B.

■ Setting the A/B value

Select A or B for recording with the white balance setting stored in memory A or B.

See page 48 on how to store the adjusted value.

- When using a commercially available ND filter, this adjustment is recommended.



■ To use the PRESET value of white balance

Select 📷 (CAMERA SET) → [WB PRESET] → a desired setting.





Setting value	Example of recording conditions
☀️ (outdoor) ([OUTDOOR])	<ul style="list-style-type: none">• When recording a night scene, neon lighting, fireworks, etc.• When recording a sunrise, sunset, etc.• Under daylight fluorescent lamp
🌃 (indoor) ([INDOOR])	<ul style="list-style-type: none">• Where lighting conditions change, such as at a party place, etc.• Under video light, such as in a studio, etc.• Under a sodium or mercury lamp
Color temperature setting ([MANU WB TEMP])	<ul style="list-style-type: none">• You can set a desired color temperature between 2300K and 15000K with 📷 (CAMERA SET) → [WB TEMP SET]. (The default setting is 6500K.)

Adjusting the color tone (Continued)



Tips

- You can change the outdoor white balance setting by setting an offset value. Press  (one push) button **[C]** while  (outdoor) is selected and turn the SEL/PUSH EXEC dial **[D]** to select an offset value from -7 (bluish) to 0 (normal, the default setting) to +7 (reddish). You can also set the white balance offset value from the menu ([WB OUTDOOR LEVEL], [WB TEMP SET], p. 89).
- You can change the color temperature. Press the  (one push) button **[C]** when [MANU WB TEMP] is set. Turn the SEL/PUSH EXEC dial **[D]** until the desired temperature appears on the LCD screen, then press the dial to set the temperature.

To save the adjusted white balance value in memory A or B

- ① Set the AUTO/MANUAL switch **[E]** to MANUAL.
- ② Press the WHT BAL button **[A]**.
- ③ Set the white balance memory switch to A ( A) or B ( B).
- ④ Capture a white subject, such as white paper, full-screen in the same lighting condition as the one in which the subject is.
- ⑤ Press the  (one push) button **[C]**. The adjusted value is stored in  A or  B. The stored color temperature appears for about 3 seconds.

Notes

- When a white balance adjustment value has not been obtained successfully,  A or  B turns to slow flashing. Adjust the subject appropriately and set the shutter speed to auto or around 1/60 (1/50), then try adjusting the white balance again.
- It may take a long time to adjust the white balance, depending on the recording conditions. If you want to perform a different operation before completing the adjustment, set the white balance memory switch **[B]** to another position to temporarily suspend white balance adjustment.

To adjust the white balance automatically

Press the WHT BAL button **[A]**.

Notes

- When you set the AUTO/MANUAL switch **[E]** to AUTO, iris, gain, ISO sensitivity, shutter speed and white balance are adjusted automatically. You cannot adjust manually.

Adjusting the black balance

Normally, you do not need to adjust the black balance.

The black balance may be inappropriately adjusted for some recording situations. If that happens, adjust the black balance. It is recommended that you adjust the black balance also when you change the lens. The adjusted settings are stored.

1 Press the MENU button during standby.

2 Select  (CAMERA SET) → [BLACK BALANCE] with the SEL/PUSH EXEC dial.

3 Following the message on the LCD screen, attach the front lens cap, and select [YES].

The black balance adjustment starts.

4 When [Completed.] appears, press the MENU button to complete the adjustment.

If [Could not adjust.] appears

Try the adjustment again.

Slow & Quick Motion recording

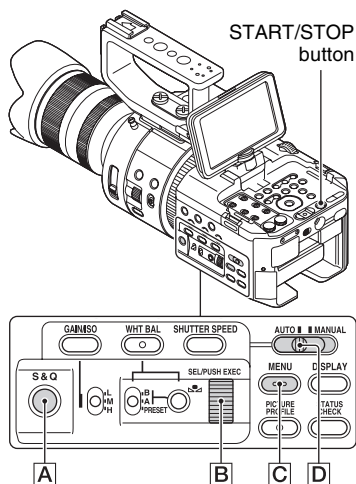

Recording with the Slow & Quick Motion function

By recording with a frame rate that is different from the playback frame rate, you can record smooth slow motion or quick motion images.

You can use the Slow & Quick Motion function with high definition image quality (HD) only.

Notes

- You must use “Memory Stick PRO-HG Duo” media or SD card Class 10 or faster for Slow & Quick Motion recording.
- When recording with the Quick Motion recording function, your camcorder may continue recording for some time (approximately 30 seconds at most) after you press the START/STOP button to stop recording. Do not operate your camcorder while the [REC] indicator is flashing on the LCD screen, and wait till it turns to [STBY].
- After you press the button to stop recording, your camcorder continues recording till it completes writing of the minimum unit of data (0.5 seconds of replay time).

1 Press the MENU button **C**.

2 Select **▶** (CAMERA SET) → [SLOW & QUICK] → [S&Q MOTION] → [FRAME RATE]/[REC FORMAT] with the SEL/PUSH EXEC dial **B**.

[FRAME RATE]: You can select the recording frame rate from the following.

When selecting [60i]

1 fps, 2 fps, 4 fps, 8 fps, 15 fps, 30 fps, 60 fps

When selecting [50i]

1 fps, 2 fps, 3 fps, 6 fps, 12 fps, 25 fps, 50 fps

[REC FORMAT]: You can select the recording format from the following.

When selecting [60i]

1080/60p PS, 1080/30p FX, 1080/30p FH, 1080/24p FX, 1080/24p FH

When selecting [50i]

1080/50p PS, 1080/25p FX, 1080/25p FH

- See page 50 on the relation between [FRAME RATE] and [REC FORMAT].

3 Select [EXECUTE].

The Slow & Quick Motion recording screen appears.

4 Press the START/STOP button, and start recording.

Slow & Quick Motion recording (Continued)

To stop Slow & Quick Motion recording

Press the START/STOP button again.

To change the frame rate setting

During standby, press and hold the S&Q button **[A]**, then change the value with the SEL/PUSH EXEC dial **[B]**.

To cancel the setting, press and hold the S&Q button again.

To cancel Slow & Quick Motion recording

Press the S&Q button **[A]** or the MENU button **[C]** during standby.

Playback speed based on the setting between [FRAME RATE] and [REC FORMAT] during Slow & Quick Motion

The playback speeds based on the recording format and frame rate setting are as follows.

When selecting [60i]

FRAME RATE	REC FORMAT		
	1080/24p	1080/30p	1080/60p
60	40% slow	50% slow	100% (standard)
30	80% slow	100% (standard)	200% quick
15	160% quick	200% quick	400% quick
8	300% quick	375% quick	750% quick
4	600% quick	750% quick	1500% quick
2	1200% quick	1500% quick	3000% quick
1	2400% quick	3000% quick	6000% quick

When selecting [50i]

FRAME RATE	REC FORMAT	
	1080/25p	1080/50p
50	50% slow	100% (standard)
25	100% (standard)	200% quick
12	208% quick	417% quick
6	417% quick	833% quick
3	833% quick	1667% quick
2	1250% quick	2500% quick
1	2500% quick	5000% quick

Notes

- The available continuous recording time is approximately 13 hours. However, it will be shorter when recording with slow motion.
- You cannot change the frame rate during Slow & Quick Motion recording. To change the frame rate, stop current Slow & Quick Motion recording.
- The time code is recorded in the [REC RUN] mode during Slow & Quick Motion recording (p. 100).
- The Slow & Quick Motion is canceled automatically when the POWER switch is set to OFF, but the frame rate setting is retained.
- You can record sound only at 100% (standard).
- The simultaneous recording on the memory card and the flash memory unit is not available.
- Slow & Quick Motion recording is not available with standard definition image quality (SD).

To record with the Super Slow Motion function

By recording with a frame rate much higher than the playback frame rate, you can record images to be played back as super slow motion images. Images recorded with the Super Slow Motion function will appear smoother than slow playback of images recorded at normal speed.

Notes

- You must use “Memory Stick PRO-HG Duo” media or SD card Class 10 or faster for Super Slow Motion recording.
- When recording with the Super Slow Motion recording function, your camcorder may continue recording for some time (approximately 6 minutes at most) after you press the START/STOP button to stop recording. Do not operate your camcorder while the [REC] indicator is flashing on the LCD screen, and wait till it turns to [STBY].
- After you press the button to stop recording, your camcorder continues recording till it completes writing of the minimum unit of data (0.5 seconds of replay time).

1 Press the MENU button .

2 Select (CAMERA SET) → [SLOW & QUICK] → [SUPER SLOW MOTION] → [FRAME RATE]/[REC FORMAT]/[REC TIMING] with the SEL/PUSH EXEC dial .

[FRAME RATE]: You can select the recording frame rate from the following.

When selecting [60i]

120 fps, 240 fps, 480 fps, 960 fps

When selecting [50i]

100 fps, 200 fps, 400 fps, 800 fps

[REC FORMAT]: You can select the recording format from the following.

When selecting [60i]

1080/60p PS, 1080/30p FX, 1080/30p FH, 1080/24p FX, 1080/24p FH

When selecting [50i]

1080/50p PS, 1080/25p FX, 1080/25p FH

[REC TIMING]: You can select the timing to start recording when pressing the START/STOP button.

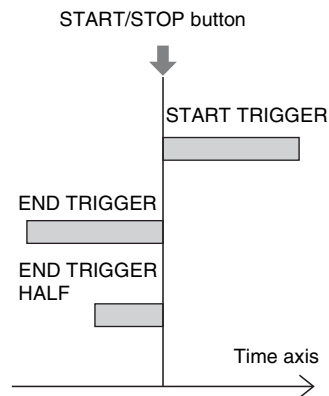

- See page 52 on the relation between [FRAME RATE] and [REC FORMAT].
- See page 52 on various recording times based on [REC TIMING].

3 Select [EXECUTE].

The Super Slow Motion recording screen appears.

4 Press the START/STOP button, and start recording.

To decide the recording time manually

If [REC TIMING] is set to [START TRIGGER], you can stop recording at any time by pressing the START/STOP button.

Slow & Quick Motion recording (Continued)

To change the frame rate setting

During standby, press and hold the S&Q button [A], then change the value of the frame rate with the SEL/PUSH EXEC dial [B].

To cancel the setting, press and hold the S&Q button again.

If you missed a scene you wished to record

To discontinue recording, touch [Cancel] on the recording screen. The contents you have recorded are not saved.

This is convenient when you wish to start recording again soon.

To cancel Super Slow Motion recording

Press the S&Q button [A] or the MENU button [C] during standby.

Playback speed based on the setting between [FRAME RATE] and [REC FORMAT] during Super Slow Motion

The playback speeds based on the recording format and frame rate setting are as follows.

When selecting [60i]

FRAME RATE	REC FORMAT		
	1080/24p	1080/30p	1080/60p
960	2.5% slow	3.125% slow	6.25% slow
480	5% slow	6.25% slow	12.5% slow
240	10% slow	12.5% slow	25% slow
120	20% slow	25% slow	50% slow

When selecting [50i]

FRAME RATE	REC FORMAT	
	1080/25p	1080/50p
800	3.125% slow	6.25% slow
400	6.25% slow	12.5% slow
200	12.5% slow	25% slow
100	25% slow	50% slow

Recording time based on the setting between [REC TIMING] and [FRAME RATE]

The approximate recording time based on the recording timing and frame rate setting are as follows.

When selecting [60i]

FRAME RATE	REC TIMING		
	START TRIGGER	END TRIGGER	END TRIGGER HALF
960	19 sec	19 sec	9 sec
480	10 sec	10 sec	5 sec
240	8 sec	8 sec	4 sec
120	16 sec	16 sec	8 sec

When selecting [50i]

FRAME RATE	REC TIMING		
	START TRIGGER	END TRIGGER	END TRIGGER HALF
800	23 sec	23 sec	11 sec
400	12 sec	12 sec	6 sec
200	9 sec	9 sec	5 sec
100	19 sec	19 sec	10 sec

Audio setup

Notes

- Super Slow Motion recording is available only when the AUTO/MANUAL switch **D** is set to MANUAL. Note that iris, gain and shutter speed are fixed to manual.
- When selecting [960] ([800]) on [FRAME RATE], the image to be displayed and recorded is approximately half the field angle.
- When selecting [480], [960] ([400], [800]) on [FRAME RATE], the image quality is deteriorated compared with the image with normal recording.
- If you adjust the gain or shutter speed, or change the white balance during Super Slow Motion recording, the image on the LCD screen changes. However, the camera setting at the time the recording ends is reflected in the recorded image.
- You cannot change the frame rate during Super Slow Motion recording. To change the frame rate, stop current Super Slow Motion recording.
- The time code is recorded in the [REC RUN] mode during Super Slow Motion recording (p. 100).
- The Super Slow Motion is canceled automatically when the POWER switch is set to OFF, but the frame rate setting is retained.
- Flicker adjustment is not effective during Super Slow Motion recording.
- You cannot record sound.
- The simultaneous recording on the memory card and the flash memory unit is not available.
- You cannot select a shutter speed value slower than the frame rate.
- You cannot use the  (one push) button during Super Slow Motion recording.

The following jacks, switches and dials allow you to set the sound to be recorded. See page 26 on connecting the microphones.

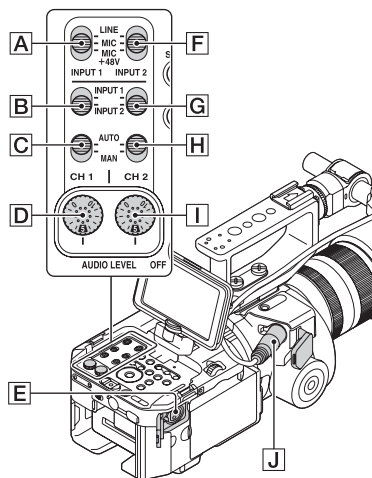

External audio jacks and switches

- INPUT 1 jack **E**
- INPUT 2 jack **J**
- INPUT 1 switch **A**
- INPUT 2 switch **F**

Audio source switches

- CH1 (INPUT 1/INPUT 2) switch **B**
- CH2 (INPUT 1/INPUT 2) switch **G**

Audio level controls

- CH1 (AUTO/MAN) switch **C**
- CH2 (AUTO/MAN) switch **H**
- AUDIO LEVEL (CH1) dial **D**
- AUDIO LEVEL (CH2) dial **I**

Recording sound via the supplied microphone

The sound will be recorded in monaural.

1 Attach the supplied microphone (p. 26) and connect it to the INPUT 2 jack [J].

2 Set the CH1 (INPUT 1/INPUT 2) [B] and CH2 (INPUT 1/INPUT 2) [G] switches to INPUT 2.

The same sound will be recorded on both CH1 and CH2.

3 Set the INPUT 2 switch [F] to MIC+48V.

Recording sound from an external audio device

To use an external audio device, or a microphone other than the supplied microphone, change the following settings.

1 Select the input source.

Set the INPUT 1/INPUT 2 switches according to the devices connected to the INPUT 1/INPUT 2 jacks.

Audio devices	Switch position
External audio device (mixer, etc.)	LINE
Dynamic microphones or microphones with a built-in battery	MIC
+48V powering (Phantom powering) microphone	MIC+48V

- If you connect a device that does not support +48V phantom power, malfunction may result from setting this switch to MIC+48V. Check before connecting the device.
- When there is no audio device connected to an INPUT jack, set the INPUT switch of that jack to LINE to prevent noise.

2 Set the input level of the microphone.

- Set the input level to the sensitivity of an XLR microphone you are using with [INPUT1 TRIM]/[INPUT2 TRIM] in the menu (p. 94). [0dB] will be appropriate for the supplied microphone (ECM-XM1).
- You can set an input level between -60 dBu (+12dB) and -30 dBu (-18dB) by 6dB. The default setting is -48 dBu (0dB).

3 Select the channel you want to record.

Using the CH1/CH2 switches, select the source to be recorded on each channel.

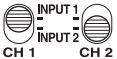
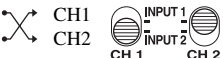
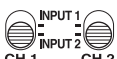
INPUT jack and recorded channel	Switch position
INPUT 1	
INPUT 1 INPUT 2	
INPUT 1 INPUT 2	
INPUT 2	

💡 Tips

- When you use a stereo microphone (2 XLR plugs), connect the L (left) channel plug to the INPUT 1 jack, and the R (right) channel plug to the INPUT 2 jack. Set the CH1 switch to INPUT 1, and the CH2 switch to INPUT 2.

Adjusting the volume

You can adjust the volume of the microphones connected to the INPUT 1/ INPUT 2 jacks.

1 Set the AUTO/MAN switch (C or H) of the channel to be adjusted to MAN.

🎵_{M2} appears on the LCD screen.

2 During recording or standby, turn the AUDIO LEVEL dial (D or I) of the channel to be adjusted.

To restore automatic adjustment

Set the AUTO/MAN switch (C or H) of the manually adjusted channel to AUTO.

Setting the headphone sound

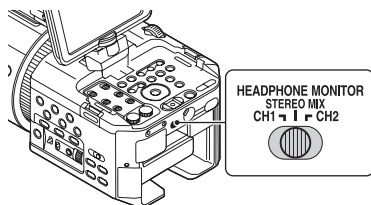

You can select the channel by setting the switch to CH1 or CH2, to output from the headphone.

See [HEADPHONE OUT] on the sound at STEREO MIX (p. 94).

Useful functions

Customizing the picture quality (Picture profile)

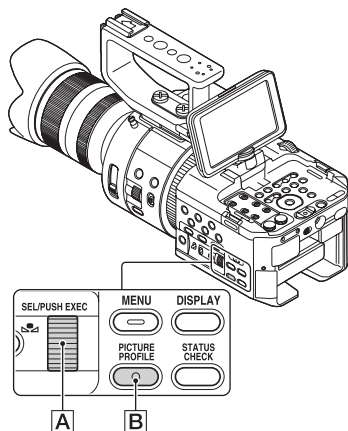

You can customize the picture quality by adjusting picture profile items such as [GAMMA] and [DETAIL]. Connect your camcorder to a TV or monitor, and adjust the picture quality while observing the picture on the TV or monitor screen.

Picture quality settings for different recording conditions have been stored in [PP1] through [PP6] as default settings.

Notes

- When you switch the recording mode, adjust the setting value as this is applied to both movie and photo.

Picture profile number	Example setting
PP1	Example settings of a color tone with [STANDARD] gamma
PP2	Example settings of a color tone with [STILL] gamma
PP3	Example settings of natural color tone with [ITU-709] gamma
PP4	Example settings of a color tone that is faithful to [ITU-709]
PP5	Example settings of a color tone with [CINE1] gamma
PP6	Example settings of a color tone with [CINE2] gamma

These example settings are for movie mode. When used in photo mode, adjust setting values accordingly.

- 1 Press the PICTURE PROFILE button [B] during standby.**
- 2 Select a picture profile number with the SEL/PUSH EXEC dial [A], then press the dial.**
You can record with the settings of the selected picture profile.
- 3 Select [OK] with the SEL/PUSH EXEC dial [A], then press the dial.**

To cancel the picture profile recording

Select [OFF] in step 2 with the SEL/PUSH EXEC dial **[A]**, then press the dial.

To change the picture profile

You can change the settings stored in [PP1] through [PP6].

- ① Press the PICTURE PROFILE button **[B]**.
- ② Select the PICTURE PROFILE number with the SEL/PUSH EXEC dial **[A]**, then press the dial.
- ③ Select [SETTING] with the SEL/PUSH EXEC dial **[A]**, then press the dial.
- ④ Select an item to be adjusted with the SEL/PUSH EXEC dial **[A]**, then press the dial.
- ⑤ Adjust the picture quality with the SEL/PUSH EXEC dial **[A]**, then press the dial.
- ⑥ Repeat steps ④ and ⑤ to adjust other items.
- ⑦ Select [**↩** RETURN] with the SEL/PUSH EXEC dial **[A]**, then press the dial.
- ⑧ Select [OK] with the SEL/PUSH EXEC dial **[A]**, then press the dial.
A picture profile indicator appears.

Useful functions (Continued)

BLACK LEVEL

To set the black level.

Item	Description and settings
	Sets the black level. -15 to +15

GAMMA

To select a gamma curve.

Item	Description and settings
[STANDARD]	Standard gamma curve for movies
[STILL]	Standard gamma curve for still images
[CINE1]	Makes soft color images by decreasing dark area contrast and sharpening bright area tone changes (HG4609G33 equivalent).
[CINE2]	Almost the same effect as [CINE1]; select this if you want to treat the image in a range within 100% of video signal when editing, etc. (HG4600G30 equivalent).
[CINE3]	Increases contrast between bright areas and dark areas more than [CINE1] and [CINE2], sharpening dark area tone changes.
[CINE4]	Increases dark area contrast more than that of [CINE3]. The dark area contrast is weaker and the bright area contrast is stronger than that of [STANDARD].
[ITU709]	Gamma curve that corresponds to ITU-709. Gain in low intensity area: 4.5

BLACK GAMMA

To correct gamma in low intensity area.

Item	Description and settings
[RANGE]	Selects a correcting range. HIGH / MIDDLE / LOW
[LEVEL]	Sets the correcting level. -7 (maximum black compression) to +7 (maximum black stretch)

KNEE

To set knee point and slope for video signal compression to prevent over-exposure by limiting signals in high intensity areas of the subject to the dynamic range of your camcorder.

When selecting [CINE1], [CINE2], [CINE3], [CINE4] or [STILL] in [GAMMA], [KNEE] is set to [OFF] even if [MODE] is set to [AUTO]. To use functions in [KNEE], set [MODE] to [MANUAL].

Item	Description and settings
[MODE]	Selects a mode either automatic or manual. [AUTO] : Sets the knee point and slope automatically. [MANUAL] : Sets the knee point and slope manually.
[AUTO SET]	Sets the maximum point and sensitivity in the automatic mode. [MAX POINT] : Sets the maximum point. 90% to 100% [SENSITIVITY] : Sets the sensitivity. HIGH / MIDDLE / LOW
[MANUAL SET]	Sets the knee point and slope manually. [POINT] : Sets the knee point. 75% to 105% [SLOPE] : Sets the knee slope. -5 (gentle) to +5 (steep) [KNEE] is set to [OFF] when you set to +5.

COLOR MODE

To set type and level of colors.

Item	Description and settings
[TYPE]	Selects a type of colors. [STANDARD] : Suitable colors when [GAMMA] is set to [STANDARD]. [STILL] : Suitable colors when [GAMMA] is set to [STILL]. [CINEMA] : Suitable colors when [GAMMA] is set to [CINE1]. [PRO] : Similar color tones to the standard image quality of Sony professional cameras (when combined with ITU-709) [ITU709 MATRIX]: Colors corresponding to ITU-709
[LEVEL]	Sets a color level when you set [TYPE] to the settings other than [STANDARD]. 1 (close to color settings of [STANDARD]) to 8 (color settings of the selected type)

COLOR LEVEL

To set the color level.

Item	Description and settings
	-8: black and white, -7 (light) to +7 (dark)

Useful functions (Continued)

COLOR PHASE

To set the color phase.

Item	Description and settings
	-7 (greenish) to +7 (reddish)

COLOR DEPTH

To set the color depth for each color phase.

This function is more effective for chromatic colors and less effective for achromatic colors. The color looks deeper as you increase the setting value to more positive side, and lighter as you decrease the value to more negative side. This function is effective even if you set [COLOR LEVEL] to [-8] (black and white).

Item	Description and settings
[R]	-7 (light red) to +7 (deep red)
[G]	-7 (light green) to +7 (deep green)
[B]	-7 (light blue) to +7 (deep blue)
[C]	-7 (light cyan) to +7 (deep cyan)
[M]	-7 (light magenta) to +7 (deep magenta)
[Y]	-7 (light yellow) to +7 (deep yellow)

WB SHIFT

To set items for the white balance shift.

Items you can adjust differ depending on the filter type.

Item	Description and settings
[FILTER TYPE]	Selects a color filter type for the white balance shift. [LB-CC] : Film type (color conversion and correction) [R-B] : Video type (correction of R and B levels)
[LB[COLOR TEMP]]	Sets a color temperature offset value. -9 (bluish) to +9 (reddish)
[CC[MG/GR]]	Sets a color correct offset value. -9 (greenish) to +9 (magentish)
[R GAIN]	Sets an R level. -9 (low R level) to +9 (high R level)
[B GAIN]	Sets a B level. -9 (low B level) to +9 (high B level)

DETAIL

To set items for the detail.

Item	Description and settings
[LEVEL]	Sets the detail level. -7 to +7
[MANUAL SET]	<p>[ON/OFF] : Turns on and off the manual detail adjustment. Set to [ON] to enable the manual detail adjustment (automatic optimization will not be performed).</p> <p>[V/H BALANCE]: Sets the vertical (V) and horizontal (H) balance of DETAIL. -2 (off to the vertical (V) side) to +2 (off to the horizontal (H) side)</p> <p>[B/W BALANCE]: Selects the balance of the lower DETAIL (B) and the upper DETAIL (W). TYPE1 (off to the lower DETAIL (B) side) to TYPE5 (off to the upper DETAIL (W) side)</p> <p>[LIMIT] : Sets the limit level of DETAIL. 0 (Low limit level: likely to be limited) to 7 (High limit level: not likely to be limited)</p> <p>[CRISPENING] : Sets the crispening level. 0 (shallow crispening level) to 7 (deep crispening level)</p> <p>[HI-LIGHT DETAIL]: Sets the DETAIL level in the high intensity areas. 0 to 4</p>

Useful functions (Continued)

COPY

To copy the settings of the picture profile to another picture profile number.

RESET

To reset the picture profile to the default setting.

To copy the picture profile setting to another picture profile number

See page 56 for the location of the buttons.

- ① Press the PICTURE PROFILE button **[B]**.
- ② Select the picture profile number that you want to copy from with the SEL/PUSH EXEC dial **[A]**, then press the dial.
- ③ Select [SETTING] → [COPY] with the SEL/PUSH EXEC dial **[A]**, then press the dial.
- ④ Select the number of the picture profile that you want to copy to with the SEL/PUSH EXEC dial **[A]**, then press the dial.
- ⑤ Select [YES] → [**↵** RETURN] → [OK] with the SEL/PUSH EXEC dial **[A]**.

To reset the picture profile settings

You can reset the picture profile settings by each picture profile number. You cannot reset all picture profile settings at once. See page 56 for the location of the buttons.

- ① Press the PICTURE PROFILE button **[B]**.
- ② Select the picture profile number that you want to reset with the SEL/PUSH EXEC dial **[A]**, then press the dial.
- ③ Select [SETTING] → [RESET] → [YES] → [**↵** RETURN] → [OK] with the SEL/PUSH EXEC dial **[A]**.

Setting time data

The camcorder records movies accompanied by time data, such as time code and user bit.

Presetting the time code

- ① Press the MENU button select **00:00** (TC/UB SET) → [TC PRESET] with the SEL/PUSH EXEC dial, then press the dial.
- ② Select [PRESET] with the SEL/PUSH EXEC dial, then press the dial.
- ③ Select the first 2 digits with the SEL/PUSH EXEC dial, then press the dial. You can set the time code within the following range.
When selecting [60i]
00:00:00:00 - 23:59:59:29
 - When setting 24p, you can set the last 2 time code digits of the frames in multiples of 4, between 0 and 23.When selecting [50i]
00:00:00:00 - 23:59:59:24
- ④ Set other digits by repeating step ③.
- ⑤ Select [OK] with the SEL/PUSH EXEC dial, then press the dial.

To reset the time code

You can reset the time code (00:00:00:00). Select [RESET] in step ② of “Presetting the time code.”

To reset the time code using the Wireless Remote Commander

You can reset the time code (00:00:00:00) also by pressing the TC RESET button on the Wireless Remote Commander.

Presetting the user bit

- ① Press the MENU button select **00:00** (TC/UB SET) → [UB PRESET] with the SEL/PUSH EXEC dial, then press the dial.

- ② Select [PRESET] with the SEL/PUSH EXEC dial, then press the dial.
- ③ Select the first 2 digits with the SEL/PUSH EXEC dial, then press the dial.
- ④ Set other digits by repeating step ③.
- ⑤ Select [OK] with the SEL/PUSH EXEC dial, then press the dial.

To reset the user bit

You can reset the user bit (00 00 00 00). Select [RESET] in step ② of “Presetting the user bit.”

Preventing accidental operation (HOLD switch)

This is useful to prevent recording errors by accidental operation.

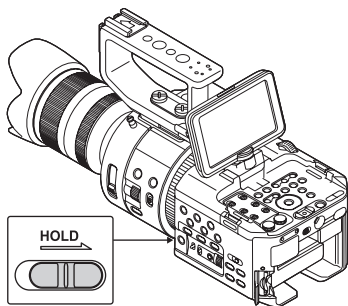

Slide the HOLD switch in the direction of the arrow.

Any operation not using the START/STOP button or PHOTO button is locked in the default setting.

To cancel the setting

Slide the HOLD switch in the opposite direction of the arrow until the yellow part disappears.

Notes

- If the setting is changed when the function is locked, the change comes into effect when the lock is canceled.
- You cannot lock the following buttons and switches.
 - POWER switch
 - ND FILTER switch
 - AUDIO LEVEL (CH1/CH2) dials
 - CH1/CH2 (INPUT1/INPUT2) switches
 - Buttons on the lens
 - Buttons on the Wireless Remote Commander

Tips

- You can change the functions to be locked with [HOLD SW MODE] (p. 103).

Reviewing the most recently recorded scene (Last Scene Review)

You can review the most recently recorded scene on the LCD screen.

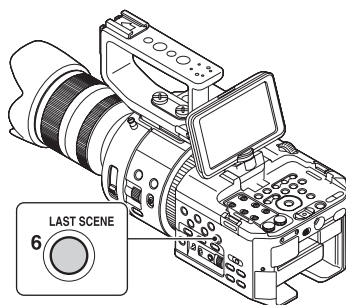

Right after you stop recording, press the LAST SCENE button.

The camcorder plays from the top to the end of the most recently recorded scene, then returns to standby mode.

To stop reviewing the last scene

Press the LAST SCENE button during playback. The camcorder returns to standby mode.

Notes

- If you edit the movie or remove the recording media after you stop recording, the Last Scene Review function may not work correctly.
- Last Scene Review is not available during Super Slow Motion.

Tips

- You can assign this function to an ASSIGN button (p. 64).

Assigning the functions to the ASSIGN buttons

Some functions can be assigned to the ASSIGN buttons for use. You can assign a single function to any one of the ASSIGN 1 to 6 buttons.

See “Menu items” (p. 84) on the function of each item.

Default function of each ASSIGN button

- ASSIGN 1: PEAKING (p. 96)
- ASSIGN 2: HISTOGRAM (p. 95)
- ASSIGN 3: FACE DETECTION (p. 39)
- ASSIGN 4: ZEBRA (p. 96)
- ASSIGN 5: MARKER (p. 96)
- ASSIGN 6: LAST SCENE (p. 63)

Functions you can assign to the ASSIGN buttons

- - (no function)
- EXPANDED FOCUS (p. 38)
- LAST SCENE REVIEW (p. 63)
- WB PRESET (p. 47)
- AE SHIFT (p. 89)
- STEADYSHOT (p. 90)
- SPOT FOCUS (p. 39)
- FACE DETECTION (p. 39)
- COLOR BAR (p. 90)
- HISTOGRAM (p. 95)
- ZEBRA (p. 96)
- PEAKING (p. 96)
- MARKER (p. 96)
- CAMERA DATA DISPLAY (p. 97)
- AUDIO LEVEL DISPLAY (p. 97)
- REC LAMP[F] (p. 102)
- REC LAMP[R] (p. 102)
- VISUAL INDEX (p. 66)
- FOCUS TRANSITION (p. 40)

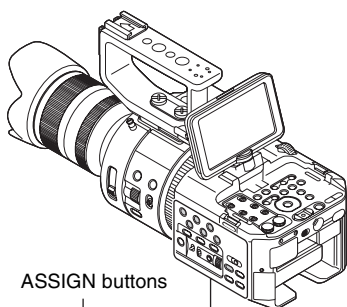

ASSIGN buttons

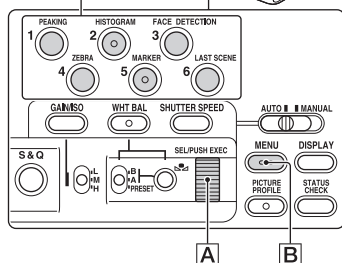

1 Press the MENU button **[B]**.

2 Select **[OTHERS]** → **[ASSIGN BUTTON]** with the SEL/PUSH EXEC dial **[A]**.

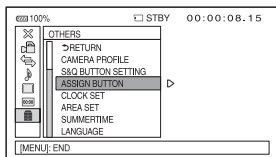

3 Select the ASSIGN button to which you want to assign a function with the SEL/PUSH EXEC dial **[A]**, then press the dial.

- [-----] appears if no function is assigned to the ASSIGN button.
- If you selected [FOCUS TRANSITION], select [YES] and jump to step 5.

4 Select the function that you want to assign with the SEL/PUSH EXEC dial **[A]**, then press the dial.

5 Select [OK] with the SEL/PUSH EXEC dial **[A]**, then press the dial.

💡 Tips

- [FOCUS TRANSITION] is assigned to the ASSIGN 4/5/6 buttons (p. 40). If you cancel the assignment of [FOCUS TRANSITION], the setting goes back to the previous setting.
- To cancel [FOCUS TRANSITION], select [FOCUS TRANSITION] → [YES] in step 3 again.

Playback

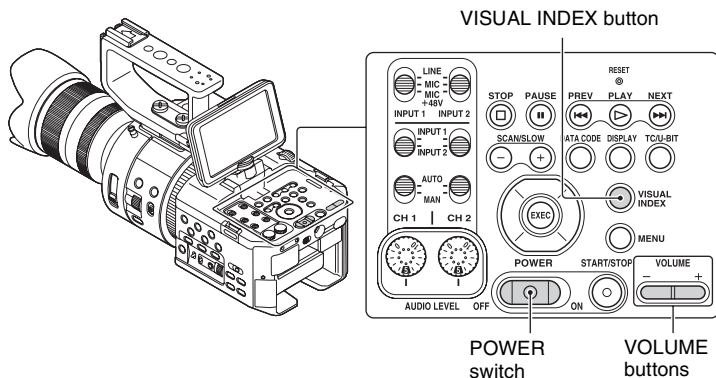

Playing back movies

- 1 Slide the **POWER** switch to **ON** while pressing the green button.

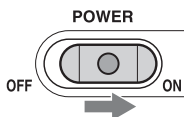

- 2 Press the **VISUAL INDEX** button.

The **VISUAL INDEX** screen appears after a few seconds.

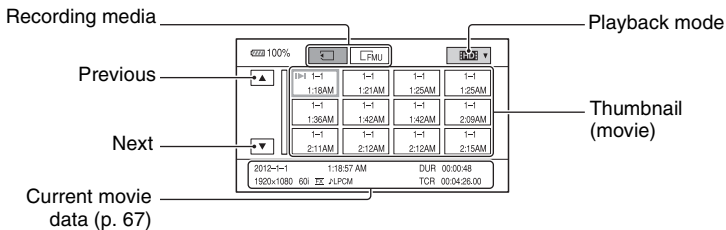

- You can turn on or off the date and time display on the thumbnails by pressing the **DISPLAY** button.

3 Playback movies.

- ① Touch the recording media you want to play back.

☐ : Memory card

☐ : FMU : Flash memory unit

- ② Touch the playback mode, and select the desired image quality of movies.

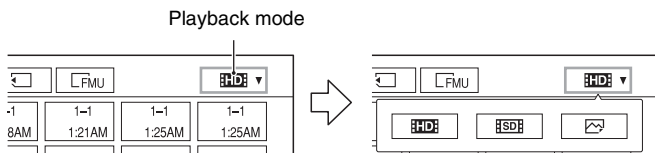

HD : High definition image quality (HD)

HSD : Standard definition image quality (SD)

- ③ Touch twice the thumbnail of the movie you want to play back.

You can also select the movie to be played back by pressing ◀/▶/⏪/⏩ buttons followed by pressing the EXEC button.

The first touch of the thumbnail will show the information on the movie at the lower part of the LCD screen.

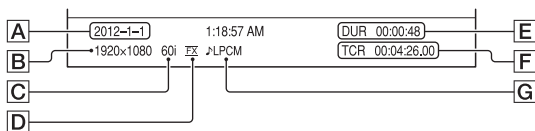

A Date and time of recording started

B Resolution

C Frame rate

D Recording mode

E Duration

F Time code of recording started

Time code will not be displayed correctly when you play back recording media with no time code, or recording media with time code that your camcorder does not support.

G LPCM recording

Appears when audio is recorded in Linear PCM. This does not appear for movies in the standard definition image quality (SD).

- ▶ appears with the movie that has been most recently played back or recorded. If you touch the movie with ▶, you can continue playback from the previous time.

Playback (Continued)

Your camcorder starts playing the selected movie.

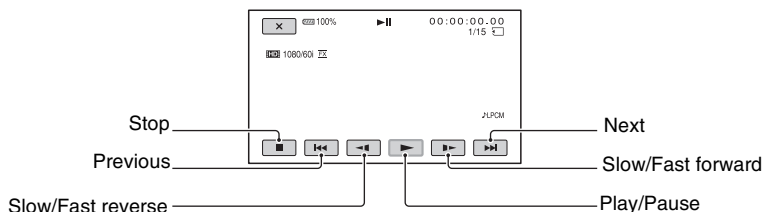

Notes

- If you touch the thumbnail and press the PLAY button, the most recently recorded or played scene is played back.

Tips

- When playback from the selected movie reaches the last movie, the screen returns to the VISUAL INDEX screen.
- Touch **⏪/⏩** during pause to play back movies slowly.
- As you repeat touching **⏮/⏭** during playback, movies are played back as fast as about 5 times → about 10 times → about 30 times → about 60 times.
- Reduced-size images which enable you to view many movies at the same time on the VISUAL INDEX screen are called “thumbnails.”
- You can operate playback using the PREV/PLAY/NEXT/STOP/PAUSE/SCAN/SLOW buttons on the camcorder.

To adjust the volume

Adjust the volume with the VOLUME buttons.

To return to the recording mode

Press the VISUAL INDEX button.

On playing back movies

- Movies recorded using this camcorder may not be played back normally on devices other than this camcorder. Also, movies recorded on other devices may not play back properly on this camcorder.
- Standard definition image quality (SD) movies recorded on SD memory cards cannot be played on A/V devices of other manufacturers.

Playing back still images

View still images.

- Touch the recording media you want to view on the VISUAL INDEX screen.

☐ : Memory card

☐ FMU: Flash memory unit

- Touch the playback mode, then select  (still image).

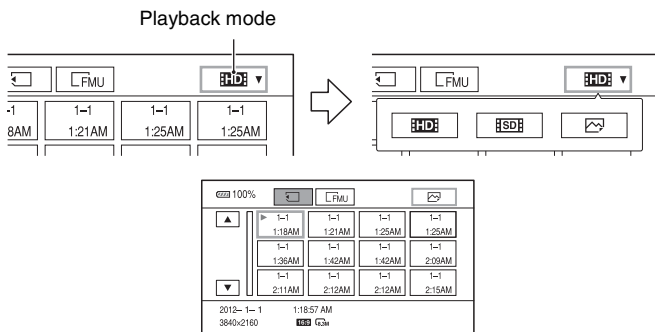

- Touch twice the thumbnail of the still image you want to view.
The first touch of the thumbnail will show the information on the still image at the lower part of the LCD screen.

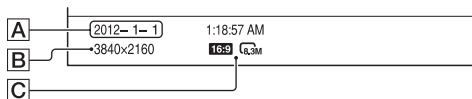

A Date and time of recording

B Resolution

C Image size

Your camcorder displays the selected still image.

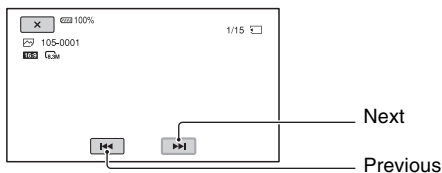

Changing/checking the settings in your camcorder

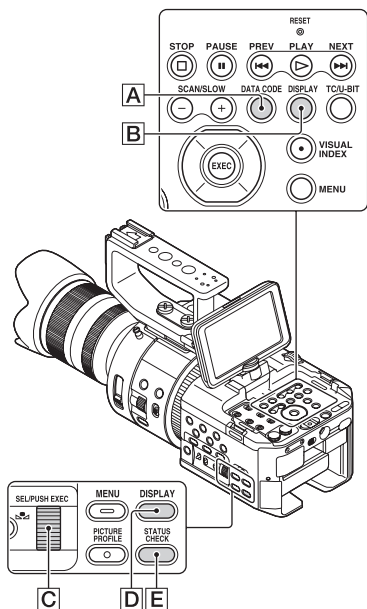

Changing the screen display

You can display information such as time code, etc., on the image.

Press the **DISPLAY** button (**B** or **D**).

The screen indicators turn on (displayed) and off (not displayed) as you press the button.

In the recording mode, the screen changes in the order, detailed display → simple display → no display with each press of the button.

Displaying recording data (Data code)

You can display information, including date, time and camera data automatically stored during recording on the screen during playback.

Press the **DATA CODE** button **A** during playback or pause.

The screen changes in the order, date and time display → camera data display → no display with each press of the button.

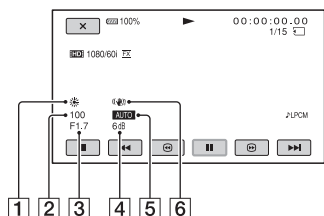

1 White balance

[WB] appears during playback of the movie recorded with [MANU WB TEMP].

2 Shutter speed

3 Iris

4 Gain/ISO sensitivity

5 Exposure

[AUTO] appears during playback of the movie recorded with the iris, gain, ISO sensitivity or shutter speed automatically adjusted. **[MANUAL]** appears during playback of the movie recorded with the iris, gain, ISO sensitivity or shutter speed manually adjusted.

6 SteadyShot

⚡ Tips

- You can display the screen indicators during playback on a TV. Select [ALL OUTPUT] of [DISPLAY OUTPUT] (p. 98).

Notes

- The exposure correction value (EV), shutter speed, iris, ISO sensitivity and flash on/off are displayed during viewing still images.
- When you play back the memory card on other devices, the camera data may be displayed incorrectly. Confirm the correct camera data on your camcorder.

Checking the settings in your camcorder (Status check)

You can check the settings of the following items.

- Audio setup (p. 94)
- Output signal setup (p. 92)
- Functions assigned to the ASSIGN buttons (p. 64)
- Camera setup (p. 88)
- Recording media information
You can check the estimated used and free spaces.

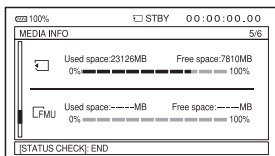

Battery Info

You can check the remaining capacity of the attached battery.

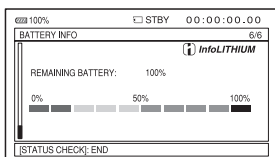

1 Press the STATUS CHECK button **E**.

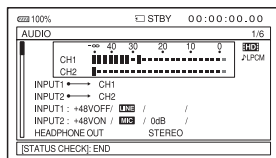

2 Turn the SEL/PUSH EXEC dial **C** until a desired display shows up on the LCD screen.

AUDIO → OUTPUT → ASSIGN →
CAMERA → MEDIA INFO →
BATTERY INFO

Setup items are displayed according to the settings of the camcorder when it is turned on.

To hide the display

Press the STATUS CHECK button **E**.

Connecting a monitor or a TV

Playback image quality depends on the type of monitor or TV, or the jacks used to make the connection.

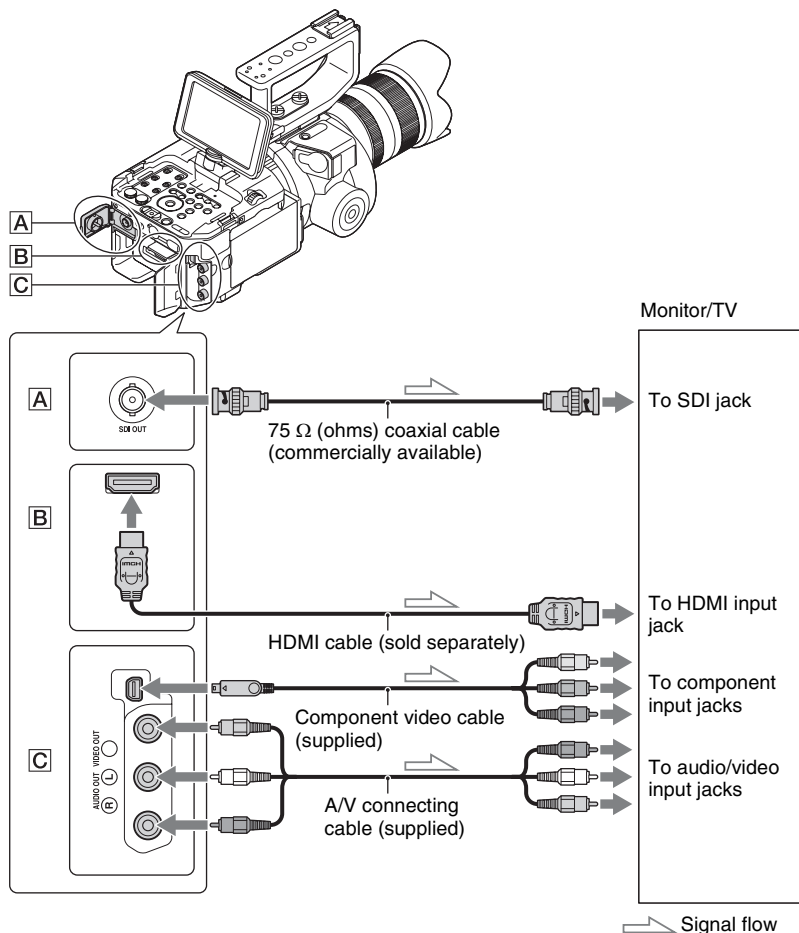

When [OUTPUT SELECT] is set to [SDI/HDMI/COMPONENT], signals are output from the SDI OUT, HDMI OUT and COMPONENT OUT jacks simultaneously. See page 92 on the format when signals are output simultaneously.

Only when [OUTPUT SELECT] is set to [VIDEO], signals are output from the VIDEO OUT jack.

Output resolution

When [OUTPUT SELECT] is set to [SDI/HDMI/COMPONENT], output resolution depends on the setting of [SDI/HDMI/COMPONENT] on [VIDEO OUT].

When selecting [60i]

HD/SD	[SDI/HDMI/COMPONENT] setting	Output resolution			
		SDI OUT	HDMI OUT	COMPONENT OUT	VIDEO OUT
HD	1080p/480i	1080p*	1080p*	1080p	No output
	720p/480i	720p	720p	720p	No output
	1080i/480i	1080i	1080i	1080i	No output
	480p	No output	480p	480p	No output
	480i	480i	480i	480i	No output
SD	1080p/480i	480i	480i	480i	No output
	720p/480i	480i	480i	480i	No output
	1080i/480i	480i	480i	480i	No output
	480p	No output	480p	480p	No output
	480i	480i	480i	480i	No output

* When outputting movies recorded with 30p or 24p on [HDMI] REC FORMAT], the output resolution differs depending on the [24p/30p OUTPUT] setting on [VIDEO OUT], as follows.

[HDMI] REC FORMAT]	[24p/30p OUTPUT]	Output resolution	
		SDI OUT	HDMI OUT
1080/30p FX 1080/30p FH	60p(Pull Down)	1080/60p	1080/60p
	24p/30p	1080/30p	1080/30p
	24PsF/30PsF	1080/30PsF	1080/30p
1080/24p FX 1080/24p FH	60p(Pull Down)	1080/60p	1080/60p
	24p/30p	1080/24p	1080/24p
	24PsF/30PsF	1080/24PsF	1080/24p

When selecting [50i]

HD/SD	[SDI/HDMI/COMPONENT] setting	Output resolution			
		SDI OUT	HDMI OUT	COMPONENT OUT	VIDEO OUT
HD	1080p/576i	1080p**	1080p**	1080p	No output
	720p/576i	720p	720p	720p	No output
	1080i/576i	1080i	1080i	1080i	No output
	576p	No output	576p	576p	No output
	576i	576i	576i	576i	No output

Connecting a monitor or a TV (Continued)

HD/SD	[SDI/HDMI/COMPONENT] setting	Output resolution			
		SDI OUT	HDMI OUT	COMPONENT OUT	VIDEO OUT
SD	1080p/576i	576i	576i	576i	No output
	720p/576i	576i	576i	576i	No output
	1080i/576i	576i	576i	576i	No output
	576p	No output	576p	576p	No output
	576i	576i	576i	576i	No output

** When outputting movies recorded with 25p on [HD] REC FORMAT], the output resolution differs depending on the [25p OUTPUT] setting on [VIDEO OUT], as follows.

[HD] REC FORMAT]	[25p OUTPUT]	Output resolution	
		SDI OUT	HDMI OUT
1080/25p FX	50p(Pull Down)	1080/50p	1080/50p
1080/25p FH	25p	1080/25p	1080/25p
	25PsF	1080/25PsF	1080/25p

Notes

- You can select the jack to output signals based on the setting of [OUTPUT SELECT].
- Signals are not output from the SDI OUT jack of your camcorder, if [SDI/HDMI/COMPONENT] is set to [480p] ([60i]) or [576p] ([50i]).
- When [OUTPUT SELECT] is set to [VIDEO], signals are output from the VIDEO OUT jack with 480i ([60i]) or 576i ([50i]).
- Use an HDMI cable with the HDMI logo.
- Images are not output from the HDMI OUT jack of your camcorder, if copyright protection signals are recorded in the movies.
- Images and sounds may not be reproduced correctly on some monitors or TVs.
- Do not connect the output jacks of the camcorder with the output jacks of the monitor or TV. A malfunction may be caused.
- Progressive signals may be converted and output depending on the settings in [HD] REC FORMAT], and whether [24p/30p OUTPUT] ([60i]) or [25p OUTPUT] ([50i]) is set.
- During recording with [HD] REC FORMAT] set to [1080/60p PS] ([60i]) or [1080/50p PS] ([50i]), or during Slow & Quick Motion recording and Super Slow Motion recording, the camcorder does not output 720p or 480p ([60i]) or 576p ([50i]) signals. Therefore, if [SDI/HDMI/COMPONENT] is set to [720p/480i] ([60i]) or [720p/576i] ([50i]), or either [480p] ([60i]) or [576p] ([50i]), the screen of the connected device becomes blank.
- If you display the edit screen while outputting signals to a monitor or TV, the menu may not be displayed correctly.
- This camcorder is not compatible with "BRAVIA" sync.

If your TV/VCR has a 21-pin adaptor (EUROCONNECTOR)

Use a 21-pin adaptor (commercially available) to view playback images.

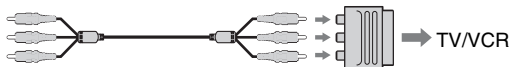

Protecting recorded movies and still images (Protect)

Protect movies and still images to avoid deleting them by mistake.

1 Press the MENU button when the VISUAL INDEX screen is displayed.



2 Select  (EDIT) → [PROTECT] with the SEL/PUSH EXEC dial.

3 Touch the movies or still images to be protected.

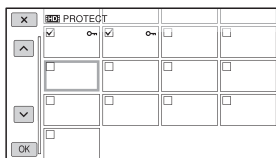
✓ is displayed on the selected images.



- Press and hold the image down to preview the image. Touch  to return to the previous screen.
- You can select up to 100 images at one time.

4 Touch  →  → .

To undo the protection of movies and still images

Touch the movie or still image marked with

- ✓ in step 3.
- ✓ disappears.

Dividing a movie

You can divide a movie at a designated point.

1 Press the **MENU** button while playing back movies.

2 Select  (**EDIT**) → [**DIVIDE**] with the **SEL/PUSH EXEC** dial.

3 Touch **II** at the point where you want to divide.

After you select the point with **II**, make fine adjustment with these buttons.

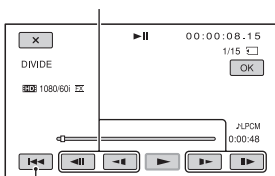

Returns to the beginning of the selected movie.

4 Touch **OK** → **OK**.

Notes

- You cannot restore movies once they are divided.
- Do not remove the battery pack, the AC Adaptor or the recording media that contains the movies from your camcorder during the operation. It may damage the recording media.
- A slight difference may occur from the point where you touch **II** and the actual dividing point, as your camcorder selects the dividing point based in about half-second increments.

Tips

- Only simple editing is available on this camcorder. Use commercially available editing software for more advanced editing.

Deleting movies and still images

You can free media space by deleting movies and still images from recording media.



Notes

- You cannot restore images once they are deleted.
- Do not remove the battery pack, the AC Adaptor or the recording media that contains the movies or still images from your camcorder during the operation. It may damage the recording media.
- You cannot delete protected movies and still images. Undo the protection of the movies and still images, before you try to delete them (p. 75).
- Save important movies and still images in advance (p. 107).

Tips

- To delete all data recorded on the recording media and recover all the recordable space of the media, format the media (p. 80).

-  appears at the upper right corner on the thumbnail of protected images.
- No check box appears on the thumbnail of protected images.

4 Touch  →  → .

1 Press the MENU button when the VISUAL INDEX screen is displayed.

2 Select  (EDIT) → [DELETE] with the SEL/PUSH EXEC dial.

3 Touch the movies or still images to be deleted.

 is displayed on the selected images.

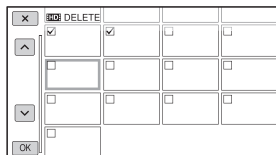

- Press and hold the image down to preview the image. Touch  to return to the previous screen.
- You can select up to 100 images at one time.

Copying movies and still images

You can copy movies and still images between following recording media:

Memory card ↔ Flash memory unit

Memory card → External media device

Flash memory unit → External media device

Get the recording media ready before the operation.

Notes

- If there is no image database file on the flash memory unit, you cannot copy movies. In this case, press the MENU button, then select  (OTHERS) → [REPAIR IMAGE DB FILE] → [FMU], to create the image database file.
- Connect your camcorder to the wall outlet (wall socket) using the supplied AC Adaptor to prevent your camcorder from running out of power during the operation.

Tips

- The original movies and still images will not be deleted after copying.

1 Press the MENU button when the VISUAL INDEX screen is displayed.

2 Select  (EDIT) → [COPY] with the SEL/PUSH EXEC dial.

3 Select the recording media to copy from and to.

4 Select [Multiple Images].



5 Select the image type ([HDD] MOVIE, [HSD] MOVIE, [ PHOTO]).

6 Touch the movies or still images to be copied.

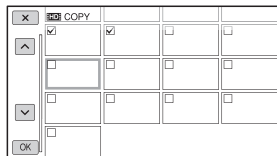
✓ is displayed on the selected image.



- Press and hold the image down to preview the image. Touch  to return to the previous screen.
- You can select up to 100 images at one time.

7 Touch  →  → .

To copy all movies or still images

Select [All] in step 4, and the image type in step 5.

Capturing still images from a movie

You can save a selected frame from a recorded movie as a still image.

1 Press the **MENU** button while playing back movies.

2 Select  (**EDIT**) → [**PHOTO CAPTURE**] with the **SEL/PUSH EXEC** dial.

3 Touch **II** at the point where you want to capture.

After you select the point with **II**, make fine adjustment with these buttons.

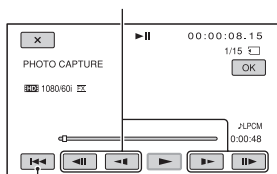

Returns to the beginning of the selected movie.

4 Touch **OK**.

The captured still image is saved on the same recording media as that of the playing movie. When capturing is finished, the screen returns to pause.

- The recording media where you want to save still images should have enough free space.
- The recording date and time of captured still images is the same as the recording date and time of the movies.
- If the movie you are capturing from has no data code, the recording date and time of the still image will be the date and time you captured from the movie.

Notes

- The image size is fixed depending on the image quality of the movie:
 - [2.1M] with high definition image quality (HD)
 - [0.2M] in 16:9 (wide) with standard definition image quality (SD)
 - [VGA(0.3M)] in 4:3 with standard definition image quality (SD)

Formatting the recording media

Formatting deletes all data from the recording media to recover recordable free space.

🔊 Notes

- Connect your camcorder to the wall outlet (wall socket) using the supplied AC Adaptor to prevent your camcorder from running out of power during the operation.
- To avoid the loss of important images, you should save them (p. 107) before formatting the recording media.
- Protected movies and still images are also deleted.

1 Press the MENU button.

2 Select (OTHERS) → [MEDIA FORMAT] with the SEL/PUSH EXEC dial.

3 Select the recording media to be formatted.

4 Touch → .

🔊 Notes

- While [Executing...] is displayed, do not operate the buttons on the camcorder, disconnect the AC Adaptor, or remove the recording media from your camcorder. (The access lamp is lit or flashing while formatting recording media.)

Preventing data on recording media from being recovered

Unintelligible data can be written on recording media. Thus, it may become more difficult to recover any original data. It is impossible to delete all data completely, even if you format the recording media. Therefore, when you dispose of or transfer the recording media, it is recommended that you perform the [Empty] operation.

🔊 Notes

- If you perform this operation, all stored data are deleted. To avoid the loss of important images, you should save them (p. 107) before the operation.
- You cannot perform this operation unless you connect the AC Adaptor to the wall outlet (wall socket).
- Disconnect all cables except the AC Adaptor. Do not disconnect the AC Adaptor during the operation.
- Do not apply any vibrations or shocks to your camcorder during this operation.

1 Connect the AC Adaptor and the power cord (mains lead) to the DC IN jack of your camcorder and the wall outlet (wall socket) (p. 20).

2 Press the MENU button.

3 Select (OTHERS) → [MEDIA FORMAT] with the SEL/PUSH EXEC dial.

4 Select the recording media to be formatted.

The format screen appears.

5 Touch [Empty] → .

Notes

- It may take from several minutes to several hours to empty recording media, depending on the capacity. You can check the actual time required on the LCD screen.
- If you stop the operation while [Executing...] is displayed, be sure to complete the operation by performing [MEDIA FORMAT] or emptying before you use the recording media next time.

Repairing the image database file

This function checks the database information and the consistency of movies and still images on the recording media, and repairs if any inconsistencies found.

Notes

- Connect your camcorder to the wall outlet (wall socket) using the supplied AC Adaptor to prevent your camcorder from running out of power during the operation.

1 Press the MENU button.

2 Select  (OTHERS) → [REPAIR IMAGE DB FILE] with the SEL/PUSH EXEC dial.

3 Select the recording media you want to check the database file.

4 Touch .

The database file check starts. Touch and quit the database file check if no inconsistency is found.

5 Touch → .

Notes

- If you stop the operation while [Repairing the image database file.] is displayed, be sure to complete the operation as described above before you use the recording media next time.

Operating the menu

You can change various settings or make detailed adjustments using the menu items displayed on the LCD screen.

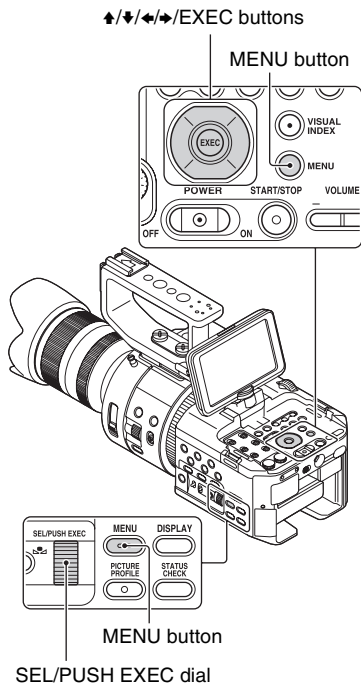

1 Press the MENU button.

The menu screen appears.

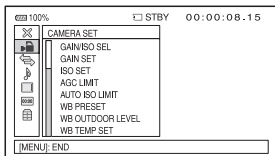

2 Turn the SEL/PUSH EXEC dial until the icon of the desired menu is highlighted, then press the dial to select the menu.

- CAMERA SET (p. 88)
- REC/OUT SET (p. 92)
- AUDIO SET (p. 94)
- DISPLAY SET (p. 95)
- TC/UB SET (p. 99)
- OTHERS (p. 101)
- EDIT (p. 87)

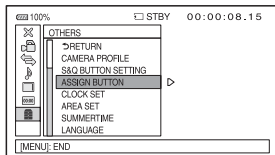

3 Turn the SEL/PUSH EXEC dial until the desired menu item is highlighted, then press the dial to select the item.

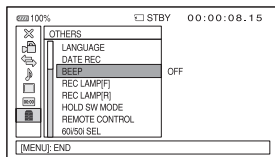

-
- 4** Turn the SEL/PUSH EXEC dial until the desired setting is highlighted, then press the dial to confirm the setting.

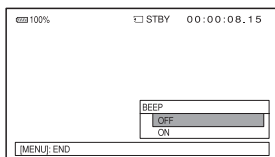

-
- 5** Press the MENU button to hide the menu screen.

To return to the previous screen, select [↵ RETURN].

Notes

- The available menu items vary depending on the context of your camcorder during recording or playback.
- Items and setting values not available due to other settings, are grayed out.



Tips

- You can operate using the /EXEC button without using the SEL/PUSH EXEC dial.

Menu items

The function and setting value of each menu item are as follows.
The default settings are marked with ▶.

(CAMERA SET) (p. 88)

GAIN/ISO SEL	▶GAIN, ISO
GAIN SET	H 0dB - 30dB ▶18dB M 0dB - 30dB ▶9dB L 0dB - 30dB ▶0dB
ISO SET	H ISO500 - ISO16000* ¹ ▶ISO3200 M ISO500 - ISO16000* ¹ ▶ISO1600 L ISO500 - ISO16000* ¹ ▶ISO500
AGC LIMIT	▶OFF, 27dB - 0dB
AUTO ISO LIMIT	▶OFF, ISO500 - ISO12800* ¹
WB PRESET	▶OUTDOOR, INDOOR, MANU WB TEMP
WB OUTDOOR LEVEL	-7 - +7 ▶0
WB TEMP SET	2300K - 15000K ▶6500K
BLACK BALANCE	
AE SHIFT	ON/OFF ▶OFF, ON LEVEL -2.0EV - +2.0EV ▶0EV
 STEADYSHOT	▶STANDARD, ACTIVE, OFF
 STEADYSHOT	▶ON, OFF

SLOW & QUICK

S&Q MOTION

REC FORMAT
[60i]
1080/60p PS,
1080/30p FX,
1080/30p FH,
▶1080/24p FX,
1080/24p FH
[50i]
1080/50p PS,
▶1080/25p FX,
1080/25p FH

FRAME RATE
[60i]
1 fps - 60 fps
▶60 fps

[50i]
1 fps - 50 fps
▶50 fps

SUPER SLOW MOTION

REC FORMAT
[60i]
1080/60p PS,
1080/30p FX,
1080/30p FH,
▶1080/24p FX,
1080/24p FH

[50i]
1080/50p PS,
▶1080/25p FX,
1080/25p FH



FRAME RATE
[60i]
120 fps - 960 fps
▶120 fps

[50i]
100 fps - 800 fps
▶100 fps

REC TIMING
START TRIGGER,
▶END TRIGGER,
END TRIGGER
HALF

FOCUS TRANSITION	TRANSITION TIME 3.5sec - 90.0sec ▶4.0sec
	START TIMER ▶OFF, 5sec - 20sec
	REC LINK ▶OFF, FOCUS-A, FOCUS-B
SPOT FOCUS	
FACE DETECTION	▶OFF, ON
AF MICRO	ON/OFF
ADJUSTMENT	▶OFF, ON
	AMOUNT -20 - +20 (▶0)
	CLEAR ALL
COLOR BAR	ON/OFF ▶OFF, ON
	TONE ▶OFF, ON

 **(REC/OUT SET)** (p. 92)

REC SET	 /  SET ▶HD, SD
	 REC FORMAT [60i] ▶1080/24p FX, 1080/24p FH, 1080/30p FX, 1080/30p FH, 1080/60p PS, 1080/60i FX, 1080/60i FH, 1080/60i HQ, 1080/60i LP, 720/60p FX, 720/60p FH

[50i]
▶1080/25p FX,
1080/25p FH,
1080/50p PS,
1080/50i FX,
1080/50i FH,
1080/50i HQ,
1080/50i LP,
720/50p FX,
720/50p FH

 SIMULTANEOUS
REC
▶ON, OFF

 WIDE REC
▶ON, OFF

MEDIA SELECT ▶MEMORY CARD,
FMU

IMAGE SIZE ▶3:2(7.0M),
16:9(8.3M)

Menu items (Continued)

VIDEO OUT	OUTPUT SELECT ▶SDI/HDMI/ COMPONENT, VIDEO SDI/HDMI/ COMPONENT [60i] ▶1080p/480i, 720p/480i, 1080i/480i, 480p, 480i [50i] ▶1080p/576i, 720p/576i, 1080i/576i, 576p, 576i 24p/30p OUTPUT* ² ▶24p/30p, 24PsF/30PsF, 60p(Pull Down) 25p OUTPUT* ³ ▶25p, 25PsF, 50p(Pull Down) DOWN CONVERT TYPE ▶SQUEEZE, LETTER BOX(16:9), EDGE CROP  WIDE CONVERT ▶SQUEEZE, LETTER BOX(16:9), EDGE CROP HDMI TC OUT ▶OFF, ON
-----------	--

(AUDIO SET) (p. 94)

 AUDIO FORMAT	▶LINEAR PCM, DOLBY DIGITAL
AUDIO LIMIT	▶OFF, ON
HEADPHONE OUT	▶STEREO, MONO
XLR SET	XLR AGC LINK ▶SEPARATE, LINKED INPUT1 TRIM -18dB - +12dB (▶0dB) INPUT1 WIND ▶OFF, ON INPUT2 TRIM -18dB - +12dB (▶0dB) INPUT2 WIND ▶OFF, ON

(DISPLAY SET) (p. 95)

HISTOGRAM	▶OFF, ON, On[Zebra Point]
ZEBRA	ON/OFF ▶OFF, ON LEVEL 70 - 100, 100+ (▶70)
PEAKING	ON/OFF ▶OFF, ON COLOR ▶WHITE, RED, YELLOW LEVEL HIGH, ▶MIDDLE, LOW

MARKER	ON/OFF ▶OFF, ON
CENTER	▶ON, OFF
ASPECT	▶OFF, 4:3, 13:9, 14:9, 15:9, 1.66:1, 1.85:1, 2.35:1
SAFETY ZONE	▶OFF, 80%, 90%
GUIDEFAME	▶OFF, ON
EXPANDED FOCUS MAG	×4.0, ×8.0, ▶×4.0/×8.0
CAMERA DATA DISPLAY	OFF, ▶ON
AUDIO LEVEL DISPLAY	▶ON, OFF
ZOOM DISPLAY	▶BAR, NUMBER
FOCUS DISPLAY	▶METER, FEET
SHUTTER DISPLAY	▶SECOND, DEGREE
LCD BRIGHT	▶NORMAL, BRIGHT
DISPLAY OUTPUT	▶LCD PANEL, ALL OUTPUT

(TC/UB SET) (p. 99)

TC PRESET	▶PRESET, RESET
UB PRESET	▶PRESET, RESET
TC FORMAT* ²	▶DF, NDF
TC RUN	▶REC RUN, FREE RUN
TC MAKE	▶PRESET, REGENERATE
UB TIME REC	▶OFF, ON

(OTHERS) (p. 101)

CAMERA PROFILE	LOAD, SAVE, DELETE
S&Q BUTTON SETTING	▶S&Q/SUPER SLOW, S&Q MOTION, SUPER SLOW MOTION
ASSIGN BUTTON	ASSIGN1, ASSIGN2, ASSIGN3, ASSIGN4, ASSIGN5, ASSIGN6, FOCUS TRANSITION

CLOCK SET	
AREA SET	
SUMMERTIME	▶OFF, ON
LANGUAGE	
DATE REC	▶OFF, ON
BEEP	▶OFF, ON
REC LAMP[F]	▶ON, OFF
REC LAMP[R]	▶ON, OFF
HOLD SW MODE	FULL, ▶EXCEPT REC, EXCEPT REC+CAMERA
REMOTE CONTROL	▶ON, OFF
60i/50i SEL	60i* ⁴ , 50i* ⁵
MEDIA FORMAT	MEMORY CARD, FMU, EXTERNAL MEDIA
REPAIR IMAGE DB FILE	MEMORY CARD, FMU, EXTERNAL MEDIA
USB CONNECT	
OPERATION TIME	
VERSION DISPLAY	
CALIBRATION	

(EDIT)

PROTECT	
DIVIDE	
DELETE	
PHOTO CAPTURE	
COPY	

*1 Setting range when picture profile is set to [OFF] in movie mode

*2 Settings available only when [60i/50i SEL] is set to [60i]

*3 Setting available only when [60i/50i SEL] is set to [50i]

*4 Default setting for NEX-FS700U/FS700UK

*5 Default setting for NEX-FS700E/FS700EK/
FS700/FS700K

Tips

- You can display the [EDIT] menu by pressing the MENU button when the VISUAL INDEX or playback screen is displayed.

(CAMERA SET) menu

Settings to adjust your camcorder to the recording conditions (GAIN SET/ STEADYSHOT, etc.)

The default settings are marked with ►.

See page 82 for details on selecting menu items.

Press the MENU button → select  (CAMERA SET) with the SEL/PUSH EXEC dial.

GAIN/ISO SEL

You can change the gain display between dB and ISO sensitivity during movie mode.

► GAIN

Adjusts in dB.

ISO

Adjusts in ISO sensitivity (recommended exposure index).

Notes

- This setting is fixed to [ISO] in photo mode.
- Gain and ISO sensitivity are separately saved with different values.
- This setting is available only when the AUTO/MANUAL switch is set to MANUAL.

GAIN SET

You can set gain values for H, M and L positions of the Gain/ISO switch.

Default setting:

[H]: 18dB, [M]: 9dB, [L]: 0dB

- ① Select [H], [M] or [L] with the SEL/PUSH EXEC dial.
- ② Set the gain value with the SEL/PUSH EXEC dial, then press the dial.
You can select a value between 0dB and 30dB in 3dB increments. The larger the value, the higher the gain.
- ③ Select [OK] with the SEL/PUSH EXEC dial.

Tips

- The setting is available when [GAIN/ISO SEL] is set to [GAIN] in movie mode.
- The value can be set separately from the one set in [ISO SET].

ISO SET

You can set ISO values for H, M and L positions of the Gain/ISO switch.

Default setting:

[H]:ISO3200, [M]:ISO1600, [L]:ISO500

- ① Select [H], [M] or [L] with the SEL/PUSH EXEC dial.
- ② Set the ISO sensitivity value with the SEL/PUSH EXEC dial, then press the dial.
You can select a value between ISO500 and ISO16000 (movie)/ISO400 and ISO12800 (photo) in 1/3EV increments. The larger the value, the higher the ISO sensitivity.
- ③ Select [OK] with the SEL/PUSH EXEC dial.

Setting value

The value you can set depends on the [GAMMA] setting on picture profile.

- STANDARD: ISO500 - ISO16000
- STILL: ISO400 - ISO12800
- CINE1: ISO400 - ISO12800
- CINE2: ISO320 - ISO10000
- CINE3: ISO500 - ISO16000
- CINE4: ISO640 - ISO20000
- ITU709: ISO500 - ISO16000

Tips

- The setting is available in photo mode, or when [GAIN/ISO SEL] is set to [ISO].
- The value can be set separately from the one set in [GAIN SET].

AGC LIMIT

You can select the upper limit for the Auto Gain Control (AGC).

▶ **OFF, 27dB - 0dB (3dB increments)**

🔊 Notes

- This function is not effective while you adjust the gain manually.

💡 Tips

- The setting is available when [GAIN/ISO SEL] is set to [GAIN] in movie mode.
- The value can be set separately from the one set in [AUTO ISO LIMIT].

AUTO ISO LIMIT

You can select the upper limit when ISO AUTO is set.

▶ **OFF, ISO500 - ISO12800 (movie)/
ISO400 - ISO10000 (photo) (1/3EV
increments)**

Setting value

The value you can set depends on the [GAMMA] setting on picture profile.

- STANDARD: ISO500 - ISO12800
- STILL: ISO400 - ISO10000
- CINE1: ISO400 - ISO10000
- CINE2: ISO320 - ISO8000
- CINE3: ISO500 - ISO12800
- CINE4: ISO640 - ISO16000
- ITU709: ISO500 - ISO12800

🔊 Notes

- This function is not effective while you adjust the ISO sensitivity manually.

💡 Tips

- The setting is available in photo mode, or when [GAIN/ISO SEL] is set to [ISO].
- The value can be set separately from the one set in [AGC LIMIT].

WB PRESET

You can use the preset white balance. For more details, see page 47.

WB OUTDOOR LEVEL

You can set an offset value to adjust the outdoor white balance when you set [WB PRESET] to [OUTDOOR].

**-7 - ▶0 - +7
(bluish - normal - reddish)**

WB TEMP SET

You can set the color temperature when you set [WB PRESET] to [MANU WB TEMP].

**2300K - ▶6500K - 15000K (100K
increments)**

BLACK BALANCE

See page 48.

AE SHIFT

■ ON/OFF

▶ OFF

Does not use the AE SHIFT function.

ON

Uses the AE SHIFT function. The selected value (-2.0EV for example) appears on the LCD screen.

■ LEVEL

You can set an offset value to adjust the automatic exposure adjustment value with the SEL/PUSH EXEC dial.

**-2.0EV - ▶0EV - +2.0EV (1/3EV
increments)
(dark - standard - bright)**

🔊 Notes

- This function is not effective while you adjust the iris, shutter speed, gain (ISO sensitivity) all manually.

Press the MENU button → select  (CAMERA SET) with the SEL/PUSH EXEC dial.

Tips

- You can assign [ON/OFF] to an ASSIGN button (p. 64).

STEADYSHOT

Only when attaching the lens with SteadyShot.

You can set the camera shake reduction in movie mode.

▶ STANDARD ()

Uses SteadyShot under relatively stable condition.

ACTIVE ()

Uses SteadyShot with more powerful effect.

OFF ()

Does not use SteadyShot. This setting is recommended when you use a tripod.

Notes

- [ACTIVE] can be selected only when recording movies using a lens with optical SteadyShot complying with [ACTIVE].

Tips

- You can assign this function to an ASSIGN button (p. 64).

STEADYSHOT

Only when attaching the lens with SteadyShot.

You can set the camera shake reduction in photo mode.

▶ ON ()

Uses SteadyShot.

OFF ()

Does not use SteadyShot. This setting is recommended when you use a tripod.

Tips

- You can assign this function to an ASSIGN button (p. 64).

SLOW & QUICK

See page 49.

FOCUS TRANSITION

■ TRANSITION TIME

You can set the time to shift the focus.

**3.5sec, ▶ 4.0sec, 4.5sec - 15.0sec
(0.5sec increments), 20.0sec, 30.0sec,
45.0sec, 60.0sec, 90.0sec**

■ START TIMER

You can set the time to start the transition after the ASSIGN 5 or ASSIGN 6 button is pressed.

▶ OFF, 5sec, 10sec, 20sec

■ REC LINK

You can link the time you start recording with the time focus shifts.

▶ OFF, FOCUS-A, FOCUS-B

Notes

- [FOCUS TRANSITION] function is effective only on the [EXEC] screen.

SPOT FOCUS

See page 39.

FACE DETECTION

See page 39.

AF MICRO ADJUSTMENT

When you use the LA-EA2 mount adaptor (sold separately) and an A-mount lens, you can register a specific focal setting for that lens.

■ ON/OFF

▶ OFF

Deactivates AF micro adjustment.

ON

Activates AF micro adjustment.

■ AMOUNT

You can set the adjustment value of the attached lens.

Set a higher value to focus farther from the camcorder, or set a lower value to focus closer to the camcorder.

-20 - ▶0 - +20

■ CLEAR ALL

You can clear the values of all the registered lenses.

🔗 Notes

- When [AF MICRO ADJUSTMENT] is not set to [ON], you cannot register an adjustment value.
- We recommend that you decide the value under actual shooting conditions.
- When you attach a lens that is registered on the camcorder, the registered value is displayed. If the lens is unregistered, [±0] is displayed.
- If the number of registered lenses reaches 30, the [AMOUNT] is grayed out and cannot be selected. To register any further lenses, you first need to delete already registered lenses. To do this, attach a lens to delete its registered value, then reset its value to "±0." Alternatively, you can reset the values of all lenses with [CLEAR ALL].
- If you perform AF micro adjustment with the lens of another manufacturer, the adjustment values of Sony, Minolta, and Konica Minolta lenses may be affected. Do not use this function with lenses of any other manufacturer.
- You cannot perform individual AF micro adjustment for Sony, Minolta, or Konica Minolta lenses of the same specifications.

COLOR BAR

■ ON/OFF

▶ OFF

Does not display color bars.

ON

Displays color bars on the LCD screen, records them on recording media, and outputs audio tone signals.

This function helps you to adjust colors when you view movies recorded with your camcorder on a TV or a monitor.

🔗 Notes

- This function is automatically set to [OFF] when you switch the format, perform the function by the MENU button, or turn off the camcorder.
- You cannot change the setting during recording or expanded focus operation.

■ TONE

▶ OFF

Does not output audio tone signals.

ON

Outputs audio tone signals (1 kHz: full bit -20dB ([60i]), -18dB ([50i])). Set [ON/OFF] to [ON], too.

💡 Tips

- You can assign [ON/OFF] to an ASSIGN button (p. 64).
- If you record color bars with [TONE] set to [OFF], the camcorder records sound from the microphone.

↔ (REC/OUT SET)

menu

Recording settings, input and output settings (REC SET/VIDEO OUT)

The default settings are marked with ►.

See page 82 for details on selecting menu items.

Press the MENU button → select
↔ (REC/OUT SET) with the SEL/PUSH
EXEC dial.

REC SET

■ [HD]/[SD] SET

See page 43.

■ [HD] REC FORMAT

See page 42.

■ [HD] SIMULTANEOUS REC

See page 34.

■ [SD] WIDE REC

You can set the aspect ratio when recording in standard definition image quality (SD).

► ON

Records in 16:9.

OFF (4:3)

Records in 4:3.

🔊 Notes

- When recording in high definition image quality (HD), the aspect ratio is fixed to 16:9.

MEDIA SELECT

See page 35.

IMAGE SIZE

See page 43.

VIDEO OUT

■ OUTPUT SELECT

You can select where to output images.

► SDI/HDMI/COMPONENT

VIDEO

■ SDI/HDMI/COMPONENT

You can select the resolution of the output signal from the SDI/HDMI/COMPONENT jacks.

When selecting [60i]

► 1080p/480i

720p/480i

1080i/480i

480p

480i

When selecting [50i]

► 1080p/576i

720p/576i

1080i/576i

576p

576i

💡 Tips

- See page 73 on the output resolution of the signal for each connecting cable.

■ 24p/30p OUTPUT (when selecting [60i])

You can set the output format when selecting [1080/30p FX], [1080/30p FH], [1080/24p FX] or [1080/24p FH] in [HD] REC FORMAT.

► 24p/30p

24PsF/30PsF

60p(Pull Down)

■ 25p OUTPUT (when selecting [50i])

You can set the output format when selecting [1080/25p FX] or [1080/25p FH] in [HDMI] REC FORMAT

▶ 25p

25PsF

50p(Pull Down)

■ DOWN CONVERT TYPE

You can select a down convert type when you down-convert video signal. Use this function for outputting movies and still images recorded in 16:9.

▶ SQUEEZE

Outputs a horizontally compressed image while maintaining its original height.

LETTER BOX(16:9)

Outputs a vertically compressed image while maintaining its original aspect ratio.

EDGE CROP

Outputs the central portion of the original image by cropping its right and left edges.

■ [HSD] WIDE CONVERT

You can select a down convert type when you down-convert video signal. Use this function for outputting SD movies recorded with [HSD] WIDE REC] set to [ON].

▶ SQUEEZE

Outputs a horizontally compressed image while maintaining its original height.

LETTER BOX(16:9)

Outputs a vertically compressed image while maintaining its original aspect ratio.

EDGE CROP

Outputs the central portion of the original image by cropping its right and left edges.

🔊 Notes

- When you view a movie recorded in standard definition image quality (SD) with [HSD] WIDE REC] set to [ON] on a standard 4:3 TV, images may appear horizontally compressed while maintaining its original height. In such a case, select [LETTER BOX(16:9)] or [EDGE CROP].
- If you change the setting from [SQUEEZE] to another option, or from another option to [SQUEEZE], the screen will go out momentarily, and the image and sound will be intermitted.

■ HDMI TC OUT

You can set whether to output time code to other professional-use devices, using HDMI.

▶ OFF

Does not overlap the time code information on HDMI output signal.

ON

Overlaps the time code information on HDMI output signal*. The data is transmitted as digital data, not as a projected image, and the connected device identifies the time data by referencing the transmitted digital data.

- * If the frame rate is 24p, 2-3 pulldown is performed and the converted information is automatically added and transmitted.

🎵 (AUDIO SET) menu

Settings for the audio recording
( AUDIO FORMAT/XLR SET, etc.)

The default settings are marked with ▶.
See page 82 for details on selecting menu items.

Press the MENU button → select
🎵 (AUDIO SET) with the SEL/PUSH
EXEC dial.

AUDIO FORMAT

You can set the audio format for high definition image quality (HD) recording.

▶ LINEAR PCM (🎵LPCM)

Records in Linear PCM system.

DOLBY DIGITAL (🎵DolbyD)

Records in Dolby Digital system.

🔊 Notes

- Audio format is fixed to [DOLBY DIGITAL] with the standard definition image quality (SD) recording.

AUDIO LIMIT

You can set the clipping-noise reduction function for CH1/CH2.

▶ OFF

Disables the function.

ON

Enables the function.

🔊 Notes

- This function is available only when you set the AUTO/MAN (CH1/CH2) switches to MAN.

HEADPHONE OUT

You can set the sound to output to the headphone when the HEADPHONE MONITOR switch is set to STEREO MIX.

▶ STEREO

Outputs in stereo.

MONO

Outputs in monaural.

XLR SET

■ XLR AGC LINK

You can select either linked or separate AGC (Auto Gain Control) of CH1 and CH2 when using an external microphone.

▶ SEPARATE

Separately applies the AGC for CH1/CH2. Sound inputs from CH1/CH2 will be recorded as separate sound.

LINKED (🎵A₂1)

Applies the AGC of CH1 linked with that of CH2. Sound inputs from CH1/CH2 will be recorded as a set of sound such as stereo sound. A  appears on the status check screen.

🔊 Notes

- This function is available when the CH1 and CH2 switches are both set to AUTO and the INPUT 1 and INPUT 2 switches are both set to MIC or both set to LINE (p. 53).

■ INPUT1 TRIM

You can adjust the input signal level from INPUT 1.

-18dB, -12dB, -6dB, ▶0dB, +6dB, +12dB

🔊 Notes

- The setting is not effective when you set the INPUT 1 switch to LINE.

■ INPUT1 WIND

▶ OFF

Disables wind noise reduction.

ON

Enables wind noise reduction.

 appears on the status check screen.

🔊 Notes

- The setting is not effective when you set the INPUT 1 switch to LINE.

■ INPUT2 TRIM

■ INPUT2 WIND

You can set INPUT 2 in the same way as INPUT 1.

💡 Tips

- -48 dBu is set as 0dB in your camcorder.
- Set INPUT TRIM to [0dB] for the supplied microphone.
- The INPUT TRIM function adjusts the input level from an external microphone. When using a highly sensitive microphone or recording loud sound, set this to the minus side. When using a less sensitive microphone or recording quiet sound, set it to the plus side.
- Distortion when recording loud sound may result at the input point, or at the recording point. If it is distorted at the input point, adjust the sound using the INPUT TRIM function. If it is distorted at the recording point, lower the total volume level manually.
- If you set INPUT TRIM too far to the minus side, the microphone volume becomes too low, resulting in a poor signal to noise ratio.
- Test the effect of [XLR SET] according to the microphone used or the sound field of the recording site before actual recording.

■ (DISPLAY SET) menu

Display settings (MARKER/DISPLAY OUTPUT, etc.)

The default settings are marked with ▶. See page 82 for details on selecting menu items.

Press the MENU button → select ■ (DISPLAY SET) with the SEL/PUSH EXEC dial.

HISTOGRAM

The histogram displays the luminance distribution that shows how many pixels of a particular brightness exist in the image.

▶ OFF

Does not display the histogram.

ON

Displays a histogram. A line appears at the 100% position, and the color of the zone above the line changes.



Histogram

On[Zebra Point]

The histogram shows the point where the zebra pattern appears. A line is displayed at the brightness level set with [ZEBRA].

💡 Tips

- You can assign this function to an ASSIGN button (p. 64).

Press the MENU button → select  (DISPLAY SET) with the SEL/PUSH EXEC dial.

ZEBRA

You can display a zebra pattern as a guide for adjusting brightness.

■ ON/OFF

▶ OFF

Does not display the zebra pattern.

ON (and the brightness level)

The zebra pattern is not recorded with the image.

■ LEVEL

You can select the brightness level.

▶ 70 to 100 or 100+

💡 Tips

- The zebra pattern is a stripe pattern that appears in areas of brightness equal to or exceeding the brightness level you have set.
- You can assign [ON/OFF] to an ASSIGN button (p. 64).

PEAKING

■ ON/OFF

▶ OFF

Does not display the peaking.

ON (PEAKING)

You can display an image on the LCD screen with its outlines enhanced. This function helps you to adjust the focus.

■ COLOR

You can select peaking color.

▶ WHITE, RED, YELLOW

■ LEVEL

You can select a peaking sensitivity.

HIGH, ▶ MIDDLE, LOW

🔊 Notes

- The enhanced outlines will not be recorded on the recording media.

💡 Tips

- You can focus more easily using this function in combination with the expanded focus function (p. 38).
- You can assign [ON/OFF] to an ASSIGN button (p. 64).

MARKER

■ ON/OFF

▶ OFF

Does not display markers.

ON

Displays markers. Markers are not recorded on the recording media.

■ CENTER

▶ ON

Displays a marker at the center of the LCD screen.

OFF

Does not display a center maker.



■ ASPECT

▶ OFF

Does not display the aspect ratio.

4:3, 13:9, 14:9, 15:9, 1.66:1, 1.85:1, 2.35:1

Displays markers at boundaries of display area defined by the aspect ratio.



■ SAFETY ZONE

▶ OFF

Does not display the safety zone.

80%, 90%

If you select either one, you can display markers at boundaries of display area that regular home TVs can display.



GUIDEFAME

▶ OFF

Does not display the guide frame.

ON

Displays the guide frame.

You can check the horizontal and vertical aspect of a subject.



Notes

- Only the time code is output to an external device via external output jacks when [MARKER] is set to [ON], even if [DISPLAY OUTPUT] is set to [ALL OUTPUT].
- You cannot display markers during [EXPANDED FOCUS].
- You can display markers only on the LCD screen. You cannot display them on an external device.

Tips

- You can display all types of markers at the same time.
- You can obtain a balanced composition by positioning the subject at the cross points of the guideframe marker.
- You can assign [ON/OFF] to an ASSIGN button (p. 64).

EXPANDED FOCUS MAG

You can set the magnification of expanded focus.

×4.0

×8.0

▶ ×4.0/×8.0

The setting changes in the order [×4.0] → [×8.0] → [OFF] with each press of the EXPANDED FOCUS button.

CAMERA DATA DISPLAY

OFF

Does not display the iris, gain, ISO sensitivity and shutter speed settings.

▶ ON

Constantly displays the iris, gain, ISO sensitivity and shutter speed settings on the LCD screen.

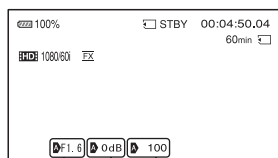

Iris value
Gain/ISO value
Shutter speed value

Tips

- The settings appear on the LCD screen during the manual adjustment regardless of the settings of this function.
-  indicates that the settings are automatically adjusted values.
- The displayed settings are different from the settings that will be displayed when you press the DATA CODE button (p. 70).
- You can assign this function to an ASSIGN button (p. 64).

AUDIO LEVEL DISPLAY

▶ ON

Displays the audio level meters on the LCD screen.

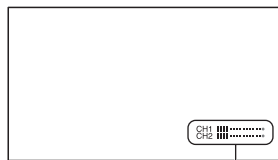

Audio level meters

OFF

Does not display the audio level meters.

Press the MENU button → select  (DISPLAY SET) with the SEL/PUSH EXEC dial.

Tips

- You can assign this function to an ASSIGN button (p. 64).

ZOOM DISPLAY

► BAR

Displays a bar that indicates the zoom position.

NUMBER

Displays a number (0 through 99) that indicates the zoom position.

FOCUS DISPLAY

► METER

Displays the focal length in meters.

FEET

Displays the focal length in feet.

SHUTTER DISPLAY



► SECOND

Displays the shutter display in seconds.

DEGREE

Displays the shutter display in degrees.

The shutter speed equal to the period that your camcorder reads image data from the image sensor is defined as 360 degrees. The degree is calculated based on this definition and displayed.

- With a frame rate of 60 selected in [ HD] REC FORMAT], when the shutter speed is 1/60, the shutter angle is 360 degrees.
- With a frame rate of 30 selected in [ HD] REC FORMAT], when the shutter speed is 1/30, the shutter angle is 360 degrees.
- With a frame rate of 24 selected in [ HD] REC FORMAT], when the shutter speed is 1/24, the shutter angle is 360 degrees.

– With a frame rate of 50 selected in [ HD] REC FORMAT], when the shutter speed is 1/50, the shutter angle is 360 degrees.

– With a frame rate of 25 selected in [ HD] REC FORMAT], when the shutter speed is 1/25, the shutter angle is 360 degrees.

See page 42 for details on [ HD] REC FORMAT] setting.

Notes

- When pressing the DATA CODE button, shutter speed is displayed in seconds regardless of this setting.

Tips

- If the shutter speed is more than 360 degrees, it is displayed as an integral multiple of 360 degrees (360° x 2, etc.).

LCD BRIGHT

You can adjust the brightness of the LCD screen. Changes in the LCD brightness are not affect the brightness of recording images.

► NORMAL

BRIGHT

DISPLAY OUTPUT

You can select where to output the display information, such as time code.

► LCD PANEL

Outputs the information to the LCD screen.

ALL OUTPUT

Outputs information to the SDI OUT, HDMI OUT, COMPONENT OUT and VIDEO OUT jacks, and the LCD screen. Zebra, peaking and the frame on the face are also output.

Notes

- Only the time code, zebra, peaking and the frame on the face are output when [MARKER] is set to [ON] and a marker is displayed on the LCD screen.

00:00 (TC/UB SET) menu

Time code settings (TC PRESET/UB PRESET/TC FORMAT, etc.)

The default settings are marked with ►. See page 82 for details on selecting menu items.

Press the MENU button → select 00:00 (TC/UB SET) with the SEL/PUSH EXEC dial.

TC PRESET

See page 62.

UB PRESET

See page 62.

TC FORMAT

You can select the time code recording method when [60i/50i SEL] is set to [60i]. This setting is fixed to [NDF] when [50i] is set.

► DF

Records the time code in drop frame.

NDF

Records the time code in non-drop frame.

Notes

- This setting is fixed to [NDF] when recording in **HD** 1080/24p, even if [60i/50i SEL] is set to [60i].

Tips

Drop frame

Time code is based on 30 frames per second; however, gaps in the actual time occur during extended periods of recording as the actual frame frequency of NTSC image signal is 29.97 frames per second. Drop frame corrects this gap to make time code and actual time equal. In drop frame, the first 2 frame numbers are removed every minute except in every tenth minute. Time code without this correction is called non-drop frame.

Press the MENU button → select **00:00** (TC/UB SET) with the SEL/PUSH EXEC dial.

TC RUN

You can select how the time code advances.

► REC RUN

Advances the time code only during recording.

Select this setting to record the time code sequentially from the last time code of the previous recording.

FREE RUN

Advances the time code regardless of operation of your camcorder.

🔗 Notes

- Even if the time code advances in the [REC RUN] mode, the time code may not be recorded sequentially in the following cases:
 - When the recording format is changed.
 - When the images are recorded on the memory card and the flash memory unit simultaneously.
 - When the recording media is removed.
- [REC RUN] is selected automatically for the Slow & Quick Motion recording and Super Slow Motion recording.

TC MAKE

► PRESET

Records the newly set time code on the recording media.

REGENERATE

Reads the last time code of the previous recording from the recording media and records the new time code consecutively from the last time code during the backspace editing.

The time code runs in [REC RUN] mode regardless of the setting of [TC RUN].

UB TIME REC

► OFF

Does not save the actual time in the user bit code.

ON

Saves the actual time in the user bit code.

🔗 Notes

- The last 2 digits are fixed to 00 when it is set to [ON].

(OTHERS) menu

Settings while recording or other basic settings (AREA SET/BEEP, etc.)

The default settings are marked with ►.
See page 82 for details on selecting menu items.

Press the MENU button → select  (OTHERS) with the SEL/PUSH EXEC dial.

CAMERA PROFILE

You can save up to 99 camera profile settings in a memory card for easy recall at any time.

In addition, if you should require multiple camcorders with the same settings, you can load the desired settings to all cameras via the memory card.

Notes

- A camera profile of a different [60i/50i SEL] setting is not compatible.
- The file may not be shown properly if the file name is changed on the computer, or the power turned off during generation.
- Formatting the memory card also deletes saved camera profiles.

Tips

- Items that can be saved include setting values for menus, picture profiles, buttons, etc. You can save these setting values all together in the camera profile.

■ LOAD

Load the camera profile, and execute the settings.

- ① Select the camera profile to be loaded with the SEL/PUSH EXEC dial.
- ② Select [YES] on the confirmation screen.
The camcorder restarts, and the loaded camera profile becomes effective.

Notes

- A camera profile saved on a camcorder with different model name, or edited on a computer cannot be loaded.

■ SAVE

You can save the camera profile.

- ① Select [NEW FILE] or an existing profile name with the SEL/PUSH EXEC dial.
- ② Select [YES] on the confirmation screen.
The camera profile is saved.

Tips

- When you select [NEW FILE], the profile is named [01] (when saving for the first time).
- If you select an existing camera profile, the current setting values are overwritten.
- You cannot use a computer to edit saved settings.

■ DELETE

You can delete the saved camera profile.

- ① Select the camera profile to be deleted with the SEL/PUSH EXEC dial.
- ② Select [YES] on the confirmation screen.

S&Q BUTTON SETTING

You can set the functions to assign to the S&Q button.

► S&Q/SUPER SLOW

The setting changes in the order [S&Q MOTION] → [SUPER SLOW MOTION] → [OFF] with each press of the S&Q button.

S&Q MOTION

Sets Slow & Quick Motion.

SUPER SLOW MOTION

Sets Super Slow Motion.

Tips

- This function is available when the AUTO/MANUAL switch is set to MANUAL. Note that exposure correction is set to manual automatically.

Press the MENU button → select  (OTHERS) with the SEL/PUSH EXEC dial.

ASSIGN BUTTON

See page 64.

CLOCK SET

See page 28.

AREA SET

You can adjust a time difference without stopping the clock. When you use your camcorder abroad, you can adjust the clock to the local time.

SUMMERTIME

You can change this setting without stopping the clock. Set to [ON] to move the time forward 1 hour.

▶ OFF

Does not set the summertime.

ON

Sets the summertime.

LANGUAGE

You can select the language to be used on the LCD screen.

Tips

- Your camcorder offers [ENG[SIMP]] (simplified English) in case that you cannot find your native tongue among the options.

DATE REC

▶ OFF

Does not superimpose the date and time on images.

ON

Superimposes the date and time on images.

Tips

- You can set this item only when the interlace scanning system is selected.
- When zebra or peaking is activated, the date and time characters are affected by the signal, but properly recorded on images.

BEEP

▶ OFF

Cancels the melody.

ON

Activates a melody when you start/stop recording, or when you are warned with warning indicators, etc.

REC LAMP[F] (Recording lamp [front])

▶ ON

Turns on the front camera recording lamp.

OFF

Turns off the front camera recording lamp.

Tips

- You can assign this function to an ASSIGN button (p. 64).

REC LAMP[R] (Recording lamp [rear])

▶ ON

Turns on the rear camera recording lamp.

OFF

Turns off the rear camera recording lamp.

Tips

- You can assign this function to an ASSIGN button (p. 64).

HOLD SW MODE

You can set what functions will be locked when the HOLD switch is set to ON.

FULL

Locks all functions.

▶ EXCEPT REC

Locks all functions except the START/STOP button and PHOTO button.

EXCEPT REC+CAMERA

Locks all functions except the START/STOP button, PHOTO button and camera function*.

* AUTO/MANUAL, FOCUS AUTO/MAN, FOCUS HOLD/PUSH AUTO, IRIS, Iris ring, IRIS PUSH AUTO, SHUTTER SPEED, GAIN/ISO, Gain/ISO H/M/L, WHT BAL, WHT BAL PRESET/A/B, WHT  (one push), SEL/PUSH EXEC dial

REMOTE CONTROL

▶ ON

Enables the supplied Wireless Remote Commander (p. 11).

OFF

Disables the supplied Wireless Remote Commander to prevent misoperation by the remote control of another device.

60i/50i SEL

Select the setting according to the video system of the area in which you use your camcorder.

The camcorder restarts automatically in accordance with the setting change.

60i*

Selects this when the video system is NTSC.

50i**

Selects this when the video system is PAL.

* Default setting for NEX-FS700U/FS700UK

**Default setting for NEX-FS700E/FS700EK/FS700/FS700K

🔊 Notes

- Recording media formatted or recorded at 60i (50i) cannot be recorded or played back at 50i (60i), and vice versa. If [A movie with a different video signal format from this device has been recorded. Movie recording disabled.] appears on the LCD screen after switching 60i to 50i, or 50i to 60i, try another recording media or perform [MEDIA FORMAT].
- Performing the [MEDIA FORMAT] also deletes protected movies.

MEDIA FORMAT

See page 80.

REPAIR IMAGE DB FILE

See page 81.

USB CONNECT

Select this item when [USB CONNECT] does not appear on the LCD screen by connecting the camcorder to another device with the USB cable.

OPERATION TIME

Displays the total hours of operation in 10-hour increments.

VERSION DISPLAY

Displays the current version of your camcorder and lens. Be sure to check for firmware updates.

🔊 Notes

- To perform an update, use the AC Adaptor.

CALIBRATION

See page 127.

Saving images on an external media device

You can save movies and still images on an external media device (USB storage devices), such as an external hard disk drive. You can also play back images on the camcorder or another playback device.

🔊 Notes

- Refer also to the instruction manuals supplied with the external media device.

💡 Tips

- You can import images saved on the external media device to your computer by using the supplied software “Content Management Utility.”

Functions available after saving images on an external media device

- playback of images through the camcorder (p. 105)
- importing images to a computer

Devices that cannot be used as an external media device

You cannot use the following devices as an external media device.

- media devices with a capacity exceeding 2 TB
- ordinary disc drive such as CD or DVD drive
- media devices connected via a USB hub
- media devices with built-in USB hub
- card reader

🔊 Notes

- You may not be able to use external media devices with a code function.
- The FAT file system is available for your camcorder. If the storage medium of the external device was formatted for the NTFS file system, etc., format the external media device using the camcorder before use. The format screen appears when an external media device is connected to your camcorder. Make sure that important data has not previously been saved on the external media device before you format it using the camcorder.

- Operation is not assured with every device satisfying requirements for operating.
- For details on available external media devices, go to the Sony support website in your country/region.

1 Connect the AC Adaptor and the power cord (mains lead) to the DC IN jack of your camcorder and the wall outlet (wall socket) (p. 20).

2 If the external media device has the AC power cable, connect it to the wall outlet (wall socket).

3 Connect the USB Adaptor Cable (supplied) to the external media device.

4 Turn on your camcorder, and connect the USB Adaptor Cable (supplied) to the ⚡(USB) jack of your camcorder.

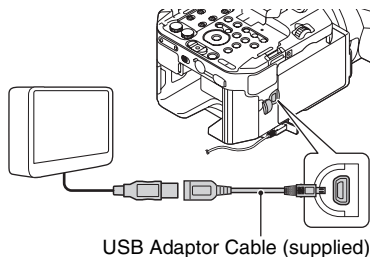

5 Touch [Copy.] on the LCD screen.

6 Select [MEMORY CARD] or [FMU] that contains the images you want to save.

Images that have not yet been saved on an external media device are saved on the connected media device at this time.

- This operation is available only when there are newly recorded images.

7 After the operation is completed, touch **OK** on the LCD screen.

Notes

- The number of scenes you can save on the external media device are as follows. Even if the external media device has free space, you cannot save scenes exceeding the following number. The number of scenes may be smaller depending on the camcorder setting and the type of images recorded.
 - High definition image quality (HD) movies: Max. 3,999
 - Standard definition image quality (SD) movies: Max. 9,999
 - Still images: Max. 40,000

Playing back images in the external media device on the camcorder

When the camcorder is connected to the external media device, the images saved in the LCD screen of the camcorder. The recording media icon on the VISUAL INDEX screen changes as follows.

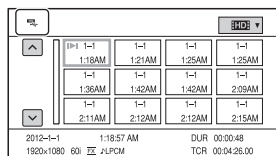

You can make menu settings of the external media device such as deleting images. Press the MENU button and select the **EDIT** menu.

Creating a standard definition image quality (SD) disc with a recorder, etc.

You can copy images on your camcorder onto a disc or video cassette, by connecting your camcorder to a disc recorder with the A/V connecting cable. Refer also to the instruction manuals supplied with the devices to be connected.

🔊 Notes

- High definition image quality (HD) movies will be copied with standard definition image quality (SD).

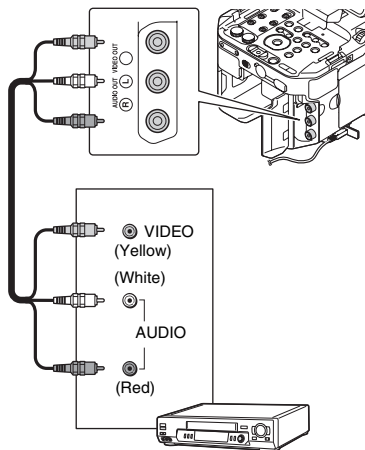

1 Connect the AC Adaptor and the power cord (mains lead) to the DC IN jack of your camcorder and the wall outlet (wall socket) (p. 20).

2 Insert the recording media in the recording device.

If your recording device has an input selector, set it to the input mode.

3 Connect your camcorder to the recording device (a disc recorder, etc.) with the A/V connecting cable (supplied).



Connect your camcorder to the input jacks of the recording device.

4 Start playback on your camcorder, and record it on the recording device.

For details, refer to the instruction manuals supplied with the device to be connected.

5 When copy is finished, stop the recording device, and then your camcorder.

🔊 Notes

- Since copying is performed via analog data transfer, the image quality may deteriorate.
- You cannot copy images to recorders connected with an HDMI cable.
- When you do not want to display the counter, etc. on the screen of the recording device, press the MENU button, and select  (DISPLAY SET) → [DISPLAY OUTPUT] → [LCD PANEL].
- To copy date/time information and camera data, press the DATA CODE button and make a desired setting. In addition, press the MENU button, select  (DISPLAY SET) → [DISPLAY OUTPUT] → [ALL OUTPUT].
- When the screen size of display devices (TV, etc.) is 4:3, set [DOWN CONVERT TYPE] (p. 93).
- When you connect a monaural device, connect the yellow plug of the A/V connecting cable to the video input jack, and the white (left channel) or the red (right channel) plug to the audio input jack on the device.

Saving images with a computer

Preparing a computer (Windows)

You can perform following operations using “Content Management Utility.”

- Importing images to a computer
- Viewing imported images
- Detecting and correcting flash bands

To save movies using a computer, install the software from the supplied CD-ROM “Content Management Utility” beforehand. Use commercially available software to edit images or create discs.

Step 1 Checking the computer system

OS*1

Microsoft Windows XP SP3*2/Windows Vista SP2*3/Windows 7

CPU

To play back movies with high definition image quality (HD) in the highest image quality mode, use an Intel Core 2 Duo 2.80 GHz CPU or faster.

Movies with high definition image quality (HD) recorded in other than the highest image quality mode may be played back with a slower CPU.

Depending on the performance of your video card, movies with high definition image quality (HD) recorded using the highest image quality mode may be played back with a slower CPU than that recommended above.

For the following operations, an Intel Pentium III 1 GHz or faster is sufficient.

- Importing movies to a computer
- Handling movies with standard definition image quality (SD) only

Memory

Windows XP: 512 MB or more (1 GB or more is recommended.)

Windows Vista/Windows 7: 1 GB or more

Hard disk

Disk volume required for installation:
Approximately 100 MB
Only the NTFS or exFAT file system can be used for importing videos or registering them for viewing.

Display

Minimum 1,024 × 768 dots

Others

USB port (this must be provided as standard, High-Speed USB (USB 2.0 compatible))
(CD-ROM drive is necessary for installation)

*1 Standard installation is required. Operation is not assured if the OS has been upgraded or in a multi-boot environment.

*2 64-bit editions and Starter (Edition) are not supported.

*3 Starter (Edition) is not supported.

Notes

- Operation with all computer environments is not assured.
- The supplied software “Content Management Utility” is not supported by Mac computers.

Step 2 Installing the supplied software “Content Management Utility”

Install “Content Management Utility” before connecting your camcorder to a computer.

- ① Confirm that your camcorder is not connected to the computer.
- ② Turn on the computer.
 - Log on as an Administrator for installation.
 - Close all applications running on the computer before installing the software.
- ③ Place the supplied CD-ROM “Content Management Utility” in the disc drive of your computer.
The installation screen appears.
 - If the screen does not appear, click [Start] → [Computer] (in Windows XP, [My Computer]), then double-click [SONYCMU(E:)] (CD-ROM).

Saving images with a computer (Continued)

- ④ Select the language for the application to be installed, then click [OK].
- ⑤ When the install wizard screen appears, click [Next].
- ⑥ Confirm the license agreement, and if you accept the terms, click [Next].
- ⑦ Select the drive or folder to install the application, then click [Next].
- ⑧ Select the option to create the desk-top shortcut, then click [Next].
- ⑨ Turn on your camcorder, then connect the camcorder to the computer using the supplied USB cable.

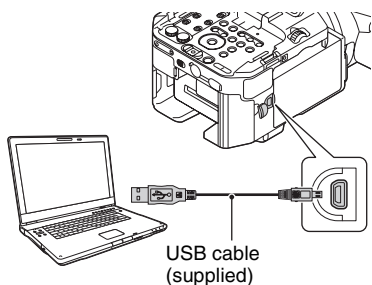

The [USB CONNECT] screen appears on the camcorder screen automatically.

- ⑩ Click [Next].
- ⑪ Follow the on-screen instructions to install the software.
 - Restart the computer if required to complete the installation.

When the installation is completed, the following icon will appear, depending on the selection in step ⑧.

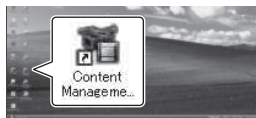

- ⑫ Remove the CD-ROM from the computer.

To disconnect your camcorder from the computer

- ① Click the  icon at the bottom right of the desktop of the computer → [Safely remove USB Mass Storage Device].



- ② Touch → [YES] on the camcorder screen.
- ③ Disconnect the USB cable.

Notes

- Use the supplied "Content Management Utility" software when you import long movies or edited images from the camcorder to a computer. If you use other software, the images may not be imported correctly.
- If file size exceeds 2 GB during a long recording, a new file is created automatically, resulting in the movie being divided into multiple files when you view the recording media directly from your computer after recording.
- If you imported images without using the supplied "Content Management Utility" software, an image divided into multiple files during recording after exceeding 2 GB may not be concatenated properly. When using other editing software, use the supplied "Content Management Utility" software to import images to a computer. The files will be concatenated and imported.

Troubleshooting

If you run into any problems using your camcorder, follow the flow chart below.

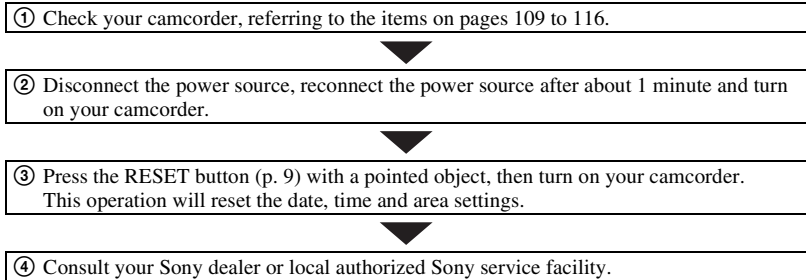

- Power sources/LCD screen/Wireless Remote Commander...p. 109
- Memory card/flash memory unit...p. 111
- Recording...p. 111
- Playback...p. 114
- Connecting to TV...p. 115
- Copying/Editing/Connecting to other devices...p. 115
- Connecting to a computer...p. 116

Power sources/LCD screen/Wireless Remote Commander

The power does not turn on or abruptly turns off.

- Attach a charged battery pack to the camcorder (p. 19).
- Use the AC Adaptor to connect the camcorder to a wall outlet (wall socket) (p. 19).

The camcorder does not operate even when the power is set to on.

- Disconnect the power source (battery or AC Adaptor), then reconnect it after about 1 minute.
- Press the RESET button (p. 9) using a pointed object.

The camcorder gets warm.

- The camcorder may get warmer while you use it. This is not a malfunction.

The remaining battery time indicator does not indicate the correct figure.

- Ambient temperature is too high or too low, or the battery pack has not been charged enough. This is not a malfunction.
- Fully charge the battery again. If the problem persists, the battery may be worn-out. Replace it with a new one (p. 19, 124).
- The indicated figure may not be correct in certain circumstances. For example, when you open or close the LCD screen, it takes about 1 minute to display the correct remaining battery.

The battery pack discharges too quickly.

- Ambient temperature is too high or low, or the battery pack has not been charged enough. This is not a malfunction.
 - Fully charge the battery again. If the problem persists, the battery may be worn-out. Replace it with a new one (p. 19, 124).
-

The image on the viewfinder is not clear.

- When the large LCD viewfinder is attached, turn the viewfinder lens adjustment ring until the image appears clearly (p. 30).
-

The supplied Wireless Remote Commander does not function.

- Set [REMOTE CONTROL] to [ON] (p. 103).
 - Remove any obstructions between the Wireless Remote Commander and the remote sensor of the camcorder.
 - Keep strong light sources, such as sunlight or overhead lighting, away from the remote sensor, otherwise the Wireless Remote Commander may not function properly.
 - Insert a fresh battery in the compartment with its +/- terminals matching those of the compartment (p. 11).
-

Another video device malfunctions when you use the supplied Wireless Remote Commander.

- Select a commander mode other than DVD2 for your video device.
 - Cover the sensor of your video device with black paper.
-

When a device is connected to the REMOTE jack, the camcorder or the device does not operate properly.

- The connected device may react slowly to some operations.
- If you disconnect the cable from the device while the cable is still connected to the camcorder's REMOTE jack, the camcorder may not restore the proper settings. Disconnect the cable also from the camcorder's REMOTE jack.

Memory card/flash memory unit

The camcorder does not operate with the memory card inserted.

- The memory card was formatted on a computer. Format it on this camcorder (p. 80).

The data file name is incorrect, or flashing.

- The file is damaged.
- Use a file format supported by your camcorder (p. 122).

The recording media indicator is flashing.

- Something wrong happened to recording media. Stop recording of all recording media, and repair the database file.

Images on the recording media cannot be deleted.

- You can select no more than 100 images to be deleted on the edit screen.
- The images are protected. Unprotect the images (p. 75).

Recording

The recording does not start when you press the START/STOP button.

- The playback screen is displayed. Finish playback operation (p. 68).
- There is no empty space on the recording media. Replace the recording media with a new one, delete unnecessary images (p. 77) or format the recording media (p. 80).
- Total number of movie scenes exceeds the recordable capacity of your camcorder (p. 120). Delete unnecessary images (p. 77).
- The temperature of your camcorder is extremely high. Turn off your camcorder and leave it for a while in a cool place.
- The temperature of your camcorder is extremely low. Turn off your camcorder and leave it for a while in a warm place.
- Something wrong happened to one of recording media. Stop recording of all recording media, and repair the database file.

The access lamp remains lit even after recording was stopped.

- Your camcorder is recording the scene you have just shot on the memory card.

The imaging field looks different.

- The imaging field may look different depending on the condition of your camcorder. This is not a malfunction.

The actual recording time for movies is less than the estimated recording time of the recording media.

- Depending on the recording conditions, the time available for recording may be shorter, for example when recording a fast moving object, etc. (p. 119).

The camcorder does not keep the setting changes.

- Some menu items return to the default setting when the power is turned off.
 - The [EXPANDED FOCUS] setting is not stored.
 - The power sources have been disconnected when the POWER switch was set to ON. Before disconnecting the battery or the AC Adaptor, set the POWER switch to OFF and make sure that the access lamp is turned off.
-

There is a time difference between the point when the START/STOP button is pressed and the point that the recording movie is started or stopped actually.

- On your camcorder, there may be a slight time difference between the point where you press the START/STOP button and the actual point that recording movie starts/stops. This is not a malfunction.
-

Still image recording takes time.

- The noise reduction processing function is working. This is not a malfunction.
-

The aspect ratio (16:9 (wide)/4:3) cannot be changed.

- The aspect ratio of high definition image quality (HD) movies is 16:9 (wide).
-

Automatic focus does not function.

- Set the FOCUS switch to AUTO to enable the automatic focus function (p. 37).
 - Adjust the focus manually if the automatic focus does not work properly (p. 37).
 - Use an E-mount lens (p. 21).
-

Menu items are grayed out or do not work.

- You cannot select grayed out display items in the current recording/playback situation.
- There are some functions you cannot activate simultaneously. The following list shows examples of unworkable combinations of functions and menu items.

Cannot use	Situation
[ON/OFF] of [AE SHIFT]	All of iris, gain or ISO sensitivity and shutter speed are set manually.
[ZEBRA], [PEAKING]	[COLOR BAR] is set to [ON].
[ON/OFF] of [MARKER]	[EXPANDED FOCUS] is set to [ON].
[TC PRESET]	[TC MAKE] is set to [REGENERATE].
[COLOR BAR]	Movies are being recorded. [EXPANDED FOCUS] is set to [ON].

Iris, gain, ISO sensitivity, shutter speed, or white balance cannot be adjusted manually.

- Set the AUTO/MANUAL switch to MANUAL.

Tiny spots in white, red, blue, or green appear on the LCD screen.

- This phenomenon appears when using a slow shutter speed (p. 45). This is not a malfunction.

The subjects passing by the frame very fast appear crooked.

- This is called the focal plane phenomenon. This is not a malfunction. Because of the way that the image device (CMOS sensor) reads out image signals, the subjects passing by the frame rapidly might appear crooked depending on the recording conditions.

Horizontal stripes appear on the image.

- This occurs when recording pictures under a fluorescent lamp, sodium lamp, or mercury lamp. This is not a malfunction. This can be improved by changing the shutter speed (p. 45).

The image appears divided horizontally.

- Images on the LCD screen look horizontally divided when a subject is continuously lit with a flash. The effect of this phenomenon may be reduced by using a slower shutter speed.
- You may try using the “Content Management Utility” software on the supplied CD-ROM to repair the image.

Black bands appear when you record a TV screen or computer screen.

- This can be improved by adjusting the shutter speed (p. 45).

Fine patterns flicker, diagonal lines look jagged.

- Adjust [DETAIL] to the negative side (p. 61).



The time code is not recorded in sequence.

- The time code may not be recorded sequentially if you change the settings of [HD/SD] SET and [HD] REC FORMAT.

Playback

Refer also to the “Memory card/flash memory unit” section (p. 111).

The desired images cannot be found. Images cannot be played back.

- Select the recording media and image quality of the image you want to play back on the VISUAL INDEX screen (p. 66).
- Image data cannot be played back if you have modified file names or folders, or have edited the data on a computer (When viewing still images, the file name flashes). This is not a malfunction (p. 124).
- Images recorded on other devices may not be played back, or displayed in incorrect size. This is not a malfunction.
- Display the VISUAL INDEX screen, touch twice on the thumbnail of the image you want to play back, or select the thumbnail with // buttons and press the EXEC button (p. 67).

The data file name is displayed incorrectly, or flashing.

- The file is damaged.
- The file format is not supported on your camcorder (p. 122).
- Only the file name is displayed, if the folder structure does not conform to the universal standard.

No sound or only a low sound is heard.

- Turn up the volume (p. 68).
- Movies recorded with [S&Q MOTION] or [SUPER SLOW MOTION] do not have sounds.

Photos cannot be played back.

- Photos may not be playable if the folder/file name is changed, or images are edited on a computer (the file name flashes). This is not a malfunction.

“---” is displayed on the LCD screen.

- Bars will be displayed for the camera data of the movies recorded with [COLOR BAR] set to [ON].
- Bars will be displayed for the exposure compensation value and flash information of the still images created with [PHOTO CAPTURE].

Multi ch appears on the LCD screen.

- This appears when you play back movies recorded with 5.1ch surround sound. 5.1ch surround sound is down-mixed to 2ch stereo and played back on your camcorder.

Connecting to TV

Neither image nor sound is played back on the TV connected with the component video cable.

- Set [VIDEO OUT] according to the requirements of the connected device (p. 92).
- When you are using the component video cable, make sure that you connect the red and white plugs of the A/V connecting cable (p. 72).

Neither image nor sound is played back on the TV connected with the HDMI cable.

- Images are not output from the HDMI OUT jack, if copyright protection signals are recorded in the images.
- Signals are not output from the HDMI OUT jack when the USB jack is connected.

Neither image nor sound is played back on the TV, projector, or AV amplifier connected with the HDMI cable.

- If you cannot view images or hear sound on the TV, projector, or AV amplifier connected with the HDMI cable, try disconnecting and connecting the HDMI cable, or turn on your camcorder again.

The image appears distorted on the 4:3 TV.

- This happens when viewing a movie recorded in the 16:9 (wide) mode on a 4:3 TV. Select  (REC/OUT SET) → [VIDEO OUT] → [DOWN CONVERT TYPE] → the appropriate down conversion type (p. 93).

Black zone appears at top and bottom of a 4:3 TV screen.

- This happens when viewing a movie recorded in the 16:9 (wide) mode on a 4:3 TV. This is not a malfunction.

Copying/Editing/Connecting to other devices

Time code and other information appear on the display of the connected device.

- Set [DISPLAY OUTPUT] to [LCD PANEL] when you connect a device with the A/V connecting cable (p. 98).

Copy cannot be done correctly using the A/V connecting cable.

- The A/V connecting cable is not connected properly. Make sure that the A/V connecting cable is connected to the input jack of the device.

Sound cannot be added to the recording media after recording.

- You cannot add sound to the recording media after recording on your camcorder.

Copy cannot be done correctly using the HDMI cable.

- You cannot copy movies using the HDMI cable.

Connecting to a computer

The computer does not recognize the camcorder.

- Disconnect the cable from the computer, then connect it again securely.
- Disconnect the cable from your computer and camcorder. Reboot your computer, and connect your computer and camcorder following the steps in the correct order (p. 107)

Movies cannot be viewed or copied to the computer.

- Disconnect the cable from the computer, then connect it again.
- You need to install the supplied “Content Management Utility” to copy movies from your camcorder to your computer (p. 107).

Warning indicators and messages

Self-diagnosis display/Warning indicators

When an error occurs, a warning indicator appears on the LCD screen. You can fix some problems associated with the symptoms yourself. If the problem persists even after you have tried a couple of times, contact your Sony dealer or local authorized Sony service facility.

C:04:□□

- The battery pack is not an “InfoLITHIUM” battery pack. Use an “InfoLITHIUM” battery pack (p. 124).

C:06:□□

- The battery pack is too hot. Replace the battery pack, or remove the battery pack and put it in a cool place.

C:13:□□

- Remove the recording media. After installing them again, operate your camcorder.

C:32:□□

- Remove the power source. Reconnect it and operate your camcorder again.

E:□□:□□

- Try the steps ② to ④ on page 109.

(Battery level warning)

- The battery pack is nearly used up.
- Depending on the operation, environment, or battery conditions,  may flash, even if around 10% is displayed as the battery remaining figure.

(Warning indicator pertaining to battery pack temperature)

- The battery pack is too hot. Replace the battery pack, or remove the battery pack and put it in a cool place.

(Warning indicator pertaining to memory cards)

Slow flashing

- Free spaces for recording images are running out. For the type of memory cards you can use with your camcorder, see page 31.
- No memory card is inserted (p. 31).

Fast flashing

- There are not enough free spaces for recording images. Delete unnecessary images (p. 77), or format the memory card (p. 80) after storing the images on other media (p. 104).
- The image database file may be damaged (p. 81).

(Warning indicator pertaining to memory card formatting)*

- The memory card is damaged.
- The memory card is not formatted correctly (p. 80).

(Warning indicator pertaining to incompatible memory cards)*

- Incompatible memory card is inserted (p. 31).

(Warning indicator pertaining to the write-protect of the memory card)*

- The write-protect switch is set to lock position on the memory card.
- Access to the memory card was restricted on another device.

FMU (Warning indicator pertaining to a flash memory unit)

Slow flashing

- Free spaces for recording images are running out. For the flash memory unit you can use with your camcorder, see page 32.
- No flash memory unit is attached (p. 32).

Fast flashing

- There are not enough free spaces for recording images. Delete unnecessary images (p. 77), or format the flash memory unit (p. 80) after storing the images on other media (p. 104).
- The image database file may be damaged (p. 81).

FMU (Warning indicator pertaining to a flash memory unit formatting)*

- The flash memory unit is damaged.
- The flash memory unit is not formatted correctly (p. 80).

(Warning indicator pertaining to the external media device)

- The image database file may be damaged (p. 81).
- The external media device is damaged.

(Warning indicator pertaining to formatting of the external media device)

- The external media device is damaged.
- Format the external media device correctly. If the message still appears, reconnect the external media device, then format it. Note that if you format the external media device, all the recorded movies and still images are deleted.
- If you cannot format the external media device, the external media device may be incompatible with your camcorder, or damaged. Replace it with a new one.

* When [BEEP] is set to [ON] (p. 102), you hear a melody when the warning indicators appear on the LCD screen.

Warning messages

If messages appear on the LCD screen, follow the instructions.

Recording time of movies and the number of recordable photos

Estimated time of recording and playback with each battery pack

Approximate time available when you use a fully charged battery pack.

Recording time

(unit: minute)

Battery pack	Continuous recording time		Typical recording time	
	60i	50i	60i	50i
NP-F770	195	210	105	130
NP-F970	290	315	160	180

Notes

- Recording format
When selecting [60i]: 1080/24p FX
When selecting [50i]: 1080/25p FX
- Using the E 18-200mm F3.5-6.3 OSS lens*
- Using ECM-XM1 connected to the INPUT1 jack
- Using a memory card
- Typical recording time shows the time when you repeat recording start/stop, turning on/off, and so on.
- Times measured when using the camcorder at 25 °C (77 °F).
- Both recording and playback time will be shorter when you use your camcorder in low temperatures. It is recommended that you use the camcorder from 10 °C to 30 °C (50 °F to 86 °F).
- The recording and playback time will be shorter depending on the conditions under which you use your camcorder.

* Supplied with NEX-FS700UK/FS700EK/FS700K.

Playing time

(unit: minute)

Battery pack	60i	50i
NP-F770	300	305
NP-F970	450	460

Estimated recording time of movies

High definition image quality (HD)

■ When [HD] AUDIO FORMAT is set to [LINEAR PCM]

(unit: minute)

	PS	FX	FH	HQ	LP
2 GB	8 (8)	9 (9)	10 (10)	20 (15)	30 (30)
4 GB	15 (15)	20 (20)	25 (25)	45 (35)	70 (60)
8 GB	35 (35)	40 (40)	55 (55)	90 (70)	145 (125)
16 GB	70 (70)	80 (80)	110 (110)	185 (145)	295 (250)
32 GB	145 (145)	170 (170)	225 (225)	375 (290)	590 (510)

■ When [HD] AUDIO FORMAT is set to [DOLBY DIGITAL]

(unit: minute)

	PS	FX	FH	HQ	LP
2 GB	9 (9)	10 (10)	10 (10)	25 (15)	45 (35)
4 GB	15 (15)	20 (20)	25 (25)	50 (40)	90 (75)
8 GB	35 (35)	40 (40)	60 (60)	105 (80)	185 (155)
16 GB	75 (75)	90 (90)	120 (120)	215 (165)	380 (310)
32 GB	150 (150)	180 (180)	245 (245)	440 (330)	770 (630)

Recording time of movies and the number of recordable photos (Continued)

Standard definition image quality (SD)

(unit: minute)

	HQ
2 GB	25 (25)
4 GB	55 (50)
8 GB	110 (100)
16 GB	225 (210)
32 GB	460 (420)

- When using Sony memory card.

Notes

- The recordable time may vary depending on the recording conditions, subjects, and [REC SET] (p. 92).
- The number in () is the minimum recordable time.

Tips

- You can record movies of a maximum of 3,999 scenes with high definition image quality (HD), and 9,999 scenes with standard definition image quality (SD).
- The maximum continuous recording time for a movie is approximately 13 hours.
- Your camcorder uses the VBR (Variable Bit Rate) format to automatically adjust image quality to suit the recording scene. This technology causes fluctuations in the recording time of the media. Movies containing quickly moving and complex images are recorded at a higher bit-rate, and this reduces the overall recording time.

Expected number of recordable photos

Memory card

	3:2(7.0M)	16:9(8.3M)
2 GB	560	520
4 GB	1100	1000
8 GB	2250	2100
16 GB	4550	4250
32 GB	9200	8500

- When using Sony memory card.
- The number of recordable photos of memory card shown is for the maximum image size of your camcorder. The actual number of recordable photos is displayed on the LCD screen during recording (p. 12).
- The number of recordable photos of memory card may vary depending on the recording conditions.

Tips

- Bit-rate (movie + audio, etc.), number of pixels, and aspect ratio of each recording mode of movies are as follows.
 - High definition image quality (HD)
PS: max. 28 Mbps 1,920 × 1,080/16:9,
FX: max. 24 Mbps 1,920 × 1,080/16:9,
1,280 × 720/16:9
FH: approx. 17 Mbps (ave.)
1,920 × 1,080/16:9, 1,280 × 720/16:9
HQ: approx. 9 Mbps (ave.)
1,440 × 1,080/16:9
LP: approx. 5 Mbps (ave.) 1,440 × 1,080/16:9
 - Standard definition image quality (SD)
HQ: approx. 9 Mbps (ave.) 720 × 576/16:9, 4:3
- Number of pixels and aspect ratio of still images
 - Recording still image:
3,840 × 2,160 dots/16:9
3,248 × 2,160 dots/3:2
 - Capturing a still image from a movie:
1,920 × 1,080 dots/16:9
640 × 360 dots/16:9
640 × 480 dots/4:3

Using your camcorder abroad

Power supply

You can use your camcorder in any country/region using the AC Adaptor/Charger supplied with your camcorder within the AC 100 V to 240 V, 50 Hz/60 Hz range.

Viewing on TV

Before recording a movie with your camcorder for viewing on a TV, set [60i/50i SEL] to the appropriate TV system for the country/region in which you intended to view the movie. The following shows which countries and regions require [60i] or [50i] setting.

Countries/regions that require [60i] on [60i/50i SEL]

Bahama Islands, Bolivia, Canada, Central America, Chile, Colombia, Ecuador, Guyana, Jamaica, Japan, Korea, Mexico, Peru, Surinam, Taiwan, the Philippines, the U.S.A., Venezuela, etc.

Countries/regions that require [50i] on [60i/50i SEL]

Argentina, Australia, Austria, Belgium, Brazil, Bulgaria, China, Czech Republic, Denmark, Finland, France, Germany, Guiana, Holland, Hong Kong, Hungary, Iran, Iraq, Italy, Kuwait, Malaysia, Monaco, New Zealand, Norway, Paraguay, Poland, Portugal, Russia, Singapore, Slovak Republic, Spain, Sweden, Switzerland, Thailand, Ukraine, United Kingdom, Uruguay, etc.

Simple setting of the clock by time difference

When you are abroad, you can easily adjust the clock to the local time by setting the time difference. Select [AREA SET], then set the time difference (p. 102).

File/folder structure on the memory card and the flash memory unit

The file/folder structure is shown below. You do not usually need to acknowledge the file/folder structure, when recording/playing back movies and still images on the camcorder.

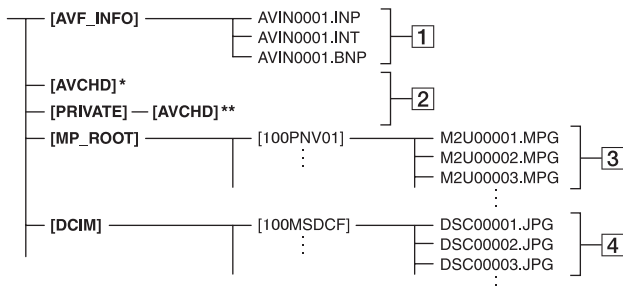

* “Memory Stick PRO Duo” media, flash memory unit

**SD memory card, SDHC memory card, SDXC memory card

1 Image management files

When you delete the files, you cannot record/play back the images correctly. The files are defaulted as hidden files and not usually displayed.

2 HD movie management information folder

This folder contains recording data of high definition image quality (HD) movies. Do not try to open this folder or access the contents of this folder from a computer. Doing so might damage image files, or prevent image files from being played back.

3 SD movie files (MPEG-2 files)

The extension of the files is “.MPG”. The maximum size is 2 GB. When the capacity of a file exceeds 2 GB, the file becomes divided. The file numbers go up automatically. When the capacity of a file number exceeds 9999, another folder is created to record new movie files. The folder name goes up: [100PNV01] → [101PNV01]

4 Still image files (JPEG files)

The extension of the files is “.JPG”. The file numbers go up automatically. When the capacity of a file number exceeds

9999, another folder is created to store new still image files. The folder name goes up: [100MSDCF] → [101MSDCF]

- Do not modify the files or folders on the camcorder from the computer. The image files may be destroyed or may not be played back. Operation is not guaranteed, if you perform this operation.
- When you delete image files, follow the steps on page 77. Do not delete the image files on the camcorder directly from the computer.
- Do not format the recording media in the camcorder using a computer. The camcorder may not operate correctly.
- Do not copy the files on the recording media from a computer. Operation is not guaranteed.
- Use the supplied application software “Content Management Utility” to import data from the recording media to a computer.

Maintenance and precautions

About the AVCHD format

What is the AVCHD format?

The AVCHD format is a high definition digital video camera format used to record an HD (high definition) signal, using efficient data compression coding technology. The MPEG-4 AVC/H.264 format is adopted to compress video data, and the Dolby Digital or Linear PCM system is used to compress audio data. The MPEG-4 AVC/H.264 format is capable of compressing images at higher efficiency than that of the conventional image compressing format.

- Because the AVCHD format uses a data compression system, images may be distorted in scenes where the image, angle, or brightness changes drastically. This is not a malfunction.

Recording and playback on your camcorder

Based on the AVCHD format, your camcorder records with the HD (high definition) image quality. In addition to HD (high definition) image quality, your camcorder is capable of recording a standard definition (SD) signal in the conventional MPEG-2 format.

Video signal*: MPEG-4 AVC/H.264

- When selecting [60i]
1920 × 1080/60p, 1920 × 1080/60i,
1920 × 1080/24p, 1280 × 720/60p,
1440 × 1080/60i
- When selecting [50i]
1920 × 1080/50p, 1920 × 1080/50i,
1280 × 720/50p, 1440 × 1080/50i

Audio signal: Dolby Digital 2ch, Linear PCM 2 ch

Recording media: memory card, flash memory unit (sold separately)

* Data recorded in AVCHD format other than the above mentioned cannot be played back on your camcorder.

About the memory card

- A memory card formatted by a computer (Windows OS/Mac OS) does not have guaranteed compatibility with your camcorder.
 - Data read/write speed may vary depending on the combination of the memory card and memory card compliant product you use.
 - Damaged or lost image data will not be compensated for, and may occur in the following cases:
 - If you eject the memory card, turn the power off on your camcorder, or remove the battery pack for replacement while your camcorder is reading or writing image files on the memory card (while the access lamp is lit or flashing).
 - If you use the memory card near magnets or magnetic fields.
 - It is recommended to make a back-up of important data on the hard disk of a computer.
 - Do not attach a label or the like on memory card or a memory card adaptor.
 - Do not touch, or allow metallic objects to come into contact with the terminals.
 - Do not bend, drop or apply strong force to the memory card.
 - Do not disassemble or modify the memory card.
 - Do not let the memory card get wet.
 - Be careful to keep memory card out of the reach of small children. There is danger that a child might swallow it.
 - Do not insert anything other than the compliant size of memory card into the memory card slot. Doing so may cause a malfunction.
 - Do not use or keep the memory card in the following locations:
 - Places subject to extremely high temperature, such as a car parked outside in the summer
 - Places under direct sunlight
 - Places with extremely high humidity or subject to corrosive gases
- **On the memory card adaptor**
- When inserting memory card into a memory card adaptor, make sure the memory card is inserted facing in the correct direction, then insert it all the way in. Note that improper use may cause a malfunction.

On image data compatibility

- Image data files recorded on a memory card by your camcorder conform to the “Design rule for Camera File system” universal standard established by the JEITA (Japan Electronics and Information Technology Industries Association).
- On your camcorder, you cannot play back still images recorded on other devices (DCR-TRV900E or DSC-D700/D770) that do not conform to the universal standard. (These models are not sold in some regions.)
- If you cannot use the memory card that has been used with another device, format it with your camcorder (p. 80). Note that formatting erases all information on the memory card.
- You may not be able to play back images with your camcorder:
 - When playing back image data modified on your computer.
 - When playing back image data recorded with other devices.



About the “Memory Stick” media

Types of “Memory Stick” media	Recording /Playback
“Memory Stick Duo” media (with MagicGate)	–
“Memory Stick PRO Duo” media (Mark2)	✓
“Memory Stick PRO-HG Duo” media	✓

- This product supports parallel data transfer. However, the transfer speed may differ, depending on the type of media you use.
- This product cannot record or play data that uses “MagicGate” technology. “MagicGate” is a copyright protection technology that records and transfers the contents in an encrypted format.

About the “InfoLITHIUM” battery pack

Your camcorder operates only with an “InfoLITHIUM” L series battery pack of a large capacity, such as NP-F770 (supplied) and NP-F970 (sold separately). You cannot use NP-F570.

“InfoLITHIUM” L series battery packs have the   mark.

What is an “InfoLITHIUM” battery pack?

An “InfoLITHIUM” battery pack is a lithium-ion battery pack that has functions for communicating information related to operating conditions between your camcorder and a supplied Charger. The “InfoLITHIUM” battery pack displays the remaining battery time in % according to the operating situations of your camcorder.

To charge the battery pack

- Be sure to charge the battery pack before you start using your camcorder.
- We recommend charging the battery pack in an ambient temperature of from 10 °C to 30 °C (50 °F to 86 °F) until the charge lamp of the Charger turns off. If you charge the battery pack outside of this temperature range, you may not be able to charge it efficiently.





To use the battery pack effectively

- Battery pack performance decreases when the ambient temperature is 10 °C (50 °F) or below, and the length of time you can use the battery pack becomes shorter. In that case, do one of the following to use the battery pack for a longer time.
 - Put the battery pack in a pocket to warm it up, and install it in your camcorder right before you start taking shots.
 - Use a large capacity battery pack: NP-F970 (sold separately).

- Be sure to set the POWER switch to OFF when not recording or playing back on your camcorder. The battery pack is also consumed when your camcorder is in recording standby or playback pause.
- Have spare battery packs ready for 2 or 3 times the expected recording time, and make trial recordings before making the actual recording.
- Do not expose the battery pack to water. The battery pack is not water resistant.

About the remaining battery indicator

- Check the level with the following indicators and % displayed on the LCD screen.

Battery remaining indicator	%
	61% to 100%
	41% to 60%
	21% to 40%
	1% to 20%
	-

- The displayed level may not be correct under certain circumstances.
- When the power goes off even though the remaining battery time indicator indicates that the battery pack has enough power to operate, charge the battery pack fully again. Remaining battery time will be indicated correctly. Note, however, that the battery indication will not be restored if it is used in high temperatures for a long time, or if left in a fully charged state, or when the battery pack is frequently used. Use the remaining battery time indication as a rough guide only.

About storage of the battery pack

- If the battery pack is not used for a long time, fully charge the battery pack and use it up on your camcorder once a year to maintain proper function. To store the battery pack, remove it from your camcorder and put it in a dry, cool place.
- To discharge the battery pack on your camcorder completely, leave your camcorder in recording standby until the power goes off.

About battery life

- Battery capacity decreases over time and through repeated use. If decreased usage time between charges becomes significant, it is probably time to replace it with a new one.
- Each battery's life is governed by storage, operating and environmental conditions.

About charging the battery pack

- Use the Charger (supplied) to charge the designated batteries only. If you charge other types of batteries, those batteries may leak, heat up, burst, or give an electric shock, resulting in burns or injury.
- Remove the charged battery from the Charger.
- The CHARGE lamp of the supplied Charger flashes in 2 patterns as follows:
 - Fast-flashing...Turns on and off rapidly at about 0.15-second intervals.
 - Slow-flashing...Turns on and off alternately for about 1.5 seconds, and turns off completely for about 1.5 seconds. The lamp repeats this sequence.
- If the CHARGE lamp is fast-flashing, remove the battery that is being charged, and then re-attach the same battery again firmly. If the CHARGE lamp continues fast-flashing, the cause could be that the battery is damaged, or the battery is not a designated type. Check the battery to confirm whether it is a designated type or not. If it is a designated type, remove the battery first, and then attach a brand-new battery or another known-to-be-good battery to see if the Charger is working correctly. If the Charger is working correctly, the cause could be that the battery is damaged.
- If the CHARGE lamp is slow-flashing, the Charger is in standby mode and charging is suspended. When the ambient temperature is out of the appropriate temperature range for charging, the Charger suspends charging automatically and enters standby mode. When the ambient temperature returns to an appropriate temperature, the Charger restarts charging and the CHARGE lamp lights up. We recommend charging the battery pack in an ambient temperature of from 10 °C to 30 °C (50 °F to 86 °F).

About handling of your camcorder

On use and care

- Do not use or store the camcorder and accessories in the following locations.
 - Anywhere extremely hot or cold. Never leave them exposed to temperatures above 60 °C (140 °F), such as under direct sunlight, near heaters or in a car parked in the sun. They may malfunction or become deformed.
 - Near strong magnetic fields or mechanical vibration. The camcorder may malfunction.
 - Near strong radio waves or radiation. The camcorder may not be able to record properly.
 - Near AM receivers and video equipment. Noise may occur.
 - On a sandy beach or anywhere dusty. If sand or dust gets in your camcorder, the camcorder may malfunction. Sometimes this malfunction cannot be repaired.
 - Near windows or outdoors, where the LCD screen, the viewfinder, or the lens may be exposed to direct sunlight. This damages the inside of the viewfinder or the LCD screen.
 - Anywhere very humid.
- Operate your camcorder on DC 7.2 V (battery pack) or DC 7.6 V (AC Adaptor).
- For DC or AC operation, use the accessories recommended in these operating instructions.
- Do not let your camcorder get wet, for example, from rain or sea water. If your camcorder gets wet, it may malfunction. Sometimes this malfunction cannot be repaired.
- If any solid object or liquid gets inside the casing, unplug your camcorder and have it checked by a Sony dealer before operating it any further.
- Avoid rough handling, disassembling, modifying, physical shock, or impact such as hammering, dropping or stepping on the product. Be particularly careful of the lens.
- Do not use a deformed or damaged battery pack.
- Keep the POWER switch set to OFF when you are not using your camcorder.
- Do not wrap your camcorder with a towel, for example, and operate it. Doing so might cause heat to build up inside.
- When disconnecting the power cord (mains lead), pull it by the plug and not the lead.

- Do not damage the power cord (mains lead) such as by placing anything heavy on it.
- Keep metal contacts clean.
- Keep the Wireless Remote Commander and button-type battery out of children's reach. If the battery is accidentally swallowed, consult a doctor immediately.
- If the battery electrolytic liquid has leaked,
 - consult your local authorized Sony service facility.
 - wash off any liquid that may have contacted your skin.
 - if any liquid gets in your eyes, wash with plenty of water and consult a doctor.

■ When not using your camcorder for a long time

- Turn on the camcorder and record and play back images about once a month to keep it in an optimum state for a long time.
- Use up the battery pack completely before storing it.

Moisture condensation

If your camcorder is brought directly from a cold place to a warm place, moisture may condense inside your camcorder and cause a malfunction of your camcorder.

■ If moisture condensation has occurred

Leave your camcorder for about 1 hour without turning it on.

■ Note on moisture condensation

Moisture may condense when you bring your camcorder from a cold place into a warm place (or vice versa) or when you use your camcorder in a humid place as shown below.

- When you bring your camcorder from a ski slope into a place warmed up by a heating device.
- When you bring your camcorder from an air conditioned car or room into a hot place outside.
- When you use your camcorder after a squall or a shower.
- When you use your camcorder in a hot and humid place.

■ How to avoid moisture condensation

When you bring your camcorder from a cold place into a warm place, put your camcorder in a plastic bag and seal it tightly. Remove the bag when the air temperature inside the plastic bag has reached the ambient temperature (after about 1 hour).

LCD screen

- Do not exert excessive pressure on the LCD screen, as it may cause damage.
- If your camcorder is used in a cold place, a residual image may appear on the LCD screen. This is not a malfunction.
- While using your camcorder, the back of the LCD screen may heat up. This is not a malfunction.

■ To clean the LCD screen

The LCD screen is covered with a coating. The coating may be peeled off by scratching or rubbing. Maintain the LCD screen as follows.

- Wipe dirt off the LCD screen with a clean, soft cloth, such as an eye glass cleaning cloth, etc.
- Before wiping the LCD screen, blow dust or sand off with a dust blower, etc.
- If you rub the LCD screen hard, even with a tissue, the coating may be damaged.
- Wipe fingerprints or hand cream off the LCD screen as soon as possible, as they may cause the coating to peel off.

■ To adjust the touch panel (CALIBRATION)

The buttons on the touch panel may not work correctly. If this happens, follow the procedure below. It is recommended that you connect your camcorder to the wall outlet (wall socket) using the supplied AC Adaptor during the operation.

- ① Press the MENU button → select  (OTHERS) → [CALIBRATION] with the SEL/PUSH EXEC dial.



- ② Touch "x" displayed on the LCD screen with the corner of memory card or the like 3 times.

🔊 Notes

- If you did not press the right spot, try the calibration again.
- Do not use a sharp-pointed object for calibration. Doing so may damage the LCD screen.
- You cannot perform the calibration when the LCD screen is turned around, or facing up and closed to the camcorder

Casing

- If the casing is soiled, clean the camcorder body with a soft cloth lightly moistened with water, and then wipe the casing with a dry soft cloth.
- Avoid the following to prevent damage to the finish.
 - Using chemicals such as thinner, benzene, alcohol, chemical cloths, repellent, insecticide and sunscreen.
 - Handling with above substances on your hands.
 - Leaving the casing in contact with rubber or vinyl objects for a long period of time.

Care and storage of the lens

- Wipe the surface of the lens clean with a soft cloth in the following instances:
 - When there are fingerprints on the lens surface.
 - In hot or humid locations
 - When the lens is exposed to salty air such as at the seaside.
- Store in a well-ventilated location subject to little dirt or dust.
- To prevent mold, periodically clean the lens as described above.

Maintenance and precautions (Continued)

Charging the pre-installed rechargeable battery

Your camcorder has a pre-installed rechargeable battery to retain the date, time, and other settings even when the POWER switch is set to OFF. The pre-installed rechargeable battery is always charged while your camcorder is connected to the wall outlet (wall socket) via the AC Adaptor or while the battery pack is attached. The rechargeable battery will be fully discharged in about **3 months** if you do not use your camcorder at all without the AC Adaptor connected or the battery pack attached. Use your camcorder after charging the pre-installed rechargeable battery.

However, even if the pre-installed rechargeable battery is not charged, the camcorder operation will not be affected as long as you are not recording the date.

■ Procedures

Connect your camcorder to a wall outlet (wall socket) using the supplied AC Adaptor or attach a charged battery, and leave it with the POWER switch set to OFF for more than 24 hours.

Removing dust from inside the viewfinder

Remove dust inside the eye piece and viewfinder with a blower.

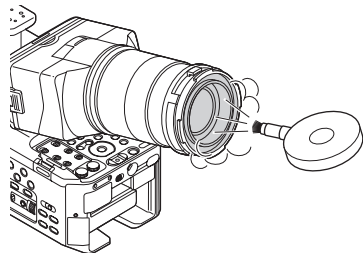

Note on disposal/transfer of the recording media

Even if you format the recording media or delete data from the recording media using your camcorder or computer, you cannot delete data from the recording media completely.

When you transfer the recording media or your camcorder, it is recommended that you delete the data completely using commercially available data deletion software to prevent the recovery of your data. Also, when you dispose of the recording media, it is recommended that you destroy the actual body of the recording media.

Specifications

System

Video signal

NTSC color, EIA standards
HDTV 1080/60i, 1080/60p, 720/60p
specification
PAL color, CCIR standards
HDTV 1080/50i, 1080/50p, 720/50p
specification

Video recording system

HD image quality: MPEG-4 AVC/
H.264 AVCHD format Ver. 2.0
compatible
SD image quality: MPEG-2 PS

Audio recording system

Linear PCM 2ch (48 kHz 16-bit)
Dolby Digital 2ch (48 kHz 16-bit)
Dolby Digital Stereo Creator employed

Still image recording system

DCF Ver. 2.0 Compatible
Exif Ver. 2.3 Compatible
MPF Baseline Compatible

Recording media (movies/still images)

“Memory Stick PRO Duo” media
Flash memory units
SD card (Class 4 or faster)

Image device

“Exmor” Super35 CMOS sensor
25.5 mm × 15.6 mm
Gross: Approx. 11 600 000 pixels
Effective (movie): Approx. 8 300 000
pixels (16:9)
Effective (photo): Approx. 8 400 000
pixels (16:9), Approx. 7 100 000 pixels
(3:2)
Recording pixels (photo):
Approx. 8 300 000 pixels (16:9),
Approx. 7 000 000 pixels (3:2)

Color temperature

[AUTO]
 (one push) A/B
[INDOOR] (3 200K)
[OUTDOOR] (5 800K)

Minimum illumination

1.2 lx (lux)* with Shutter Speed 1/24,
auto gain control, auto iris (when
selecting [60i])
1.5 lx (lux)* with Shutter Speed 1/25,
auto gain control, auto iris (when
selecting [50i])

* Using the E 18-200mm F3.5-6.3 OSS lens

Input/output connectors

VIDEO OUT jack

Pin connector
1 V_{p-p}, 75 Ω (ohms) unbalanced, sync
negative

AUDIO OUT jacks

Pin connectors
-10 dBu (at load impedance 47 kΩ
(kilohms)), Output impedance with less
than 2.2 kΩ (kilohms)
(0 dBu = 0.775 V_{rms})

COMPONENT OUT jack

Mini-D jack
Y: 1 V_{p-p}, 75 Ω (ohms)
PB/PR, CB/CR: 0.7 V_{p-p}, 75 Ω (ohms)

REMOTE jack

Stereo mini-minijack (Ø 2.5 mm)

HDMI OUT jack

HDMI Connector (Type A)

SDI OUT jack

BNC
SMPTE259M/292M/424M/425M
compatible

USB jack

mini-AB

(headphones) jack

Stereo minijack (Ø 3.5 mm)

INPUT1/INPUT2 jacks

XLR 3-pin × 2, female,
MIC: -48 dBu/3 kΩ (kilohms)
LINE: +4 dBu/10 kΩ (kilohms)
(0 dBu = 0.775 V_{rms})

Specifications (Continued)

LCD screen

Picture

8.8 cm (3.5 type, aspect ratio 16:9)

Total dot number

921 600 (1 920 × 480)

General

Power requirements

DC 7.2 V (battery pack)

DC 7.6 V (AC Adaptor)

Average power consumption

During camera recording using the microphone ECM-XM1, LCD with normal brightness (using the E 18-200 mm F3.5-6.3 OSS lens*)

When selecting [60i]: 9.6 W

When selecting [50i]: 8.8 W

When Flash Memory Unit HXR-FMU128 is used, the average power consumption increases about 1.1 W.

Operating temperature

0 °C to 40 °C (32 °F to 104 °F)

Storage temperature

-20 °C to +60 °C (-4 °F to +140 °F)

Dimensions (approx.)

Camcorder body only (including the projecting parts):

145 mm × 178.5 mm × 253.5 mm
(5 3/4 in. × 7 1/8 in. × 10 in.) (w/h/d)

When recording (including the projecting parts):

195.5 mm × 202.5 mm × 569.5 mm
(7 3/4 in. × 8 in. × 22 1/2 in.) (w/h/d)

(With the accessories (lens*, lens hood*, large LCD viewfinder, large eyecup, handle, microphone (ECM-XM1), and grip (without the belt) attached.))

Mass (approx.)

Camcorder body only:

1 680 g (3 lb 11 oz)

When recording:

3 060 g (6 lb 12 oz) (With the accessories (battery pack (NP-F770), lens*, lens hood*, large LCD viewfinder, large eyecup, handle, microphone (ECM-XM1), grip, and flash memory unit cover) attached.)

* Supplied with NEX-FS700UK/FS700EK/FS700K

AC Adaptor AC-PW10

Power requirements

AC 100 V - 240 V, 50 Hz/60 Hz

Power consumption

24 W

Output voltage

DC 7.6V*

Operating temperature

0 °C to 40 °C (32 °F to 104 °F)

Storage temperature

-20 °C to +60 °C (-4 °F to +140 °F)

Dimensions (approx.)

127 mm × 35 mm × 63 mm
(5 in. × 1 7/16 in. × 2 1/2 in.) (w/h/d)
excluding the projecting parts

Mass (approx.)

300 g (10 oz.) excluding the power cord
(mains lead)

* See the label on the AC Adaptor for other specifications.

Charger AC-VL1

Power requirements

AC 100 V - 240 V, 50 Hz/60 Hz

Power consumption

22 W

Output voltage

DC 8.4 V*

Operating temperature

0 °C to 40 °C (32 °F to 104 °F)

Storage temperature

-20 °C to +60 °C (-4 °F to +140 °F)

Dimensions (approx.)

136 mm × 51 mm × 90 mm
(5 3/8 in. × 2 1/8 in. × 3 5/8 in.) (w/h/d)
excluding the projecting parts

Mass (approx.)

270 g (9.6 oz) excluding the power cord
(mains lead)

* See the label on the Charger for other specifications.

Rechargeable battery pack NP-F770**Maximum output voltage**

DC 8.4 V

Output voltage

DC 7.2 V

Maximum charge voltage

DC 8.4 V

Maximum charge current

3.0 A

Capacity

Typical: 31.7 Wh (4 400 mAh)
Minimum: 30.0 Wh (4 200 mAh)

Type

Li-ion

**E 18-200mm F3.5-6.3 OSS lens
(Supplied with NEX-FS700UK/
FS700EK/FS700K)****Lens**

E-mount lens

When converted to a 35 mm still camera

30.6 mm - 340 mm
(1 1/4 in. - 13 1/2 in.) (16:9)
34.2 mm - 380 mm (1 3/8 in. - 15 in.)
(3:2)

F-value

F3.5-F6.3

SteadyShot

Optical-shift biaxial-linear-drive and
hall effect sensor

Minimum focus*

0.30 m (W) - 0.50 m (T) (11 7/8 in. -
19 3/4 in.)

Maximum magnification

×0.35

Minimum f-stop

f/22 - f/40

Filter diameter

67 mm (2 3/4 in.)

**Dimensions (approx. max. diameter ×
height)**

75.5 mm × 99.0 mm (3 in. × 4 in.)

Mass (approx.)

524 g (18 1/2 oz.)

* Minimum focus is the shortest distance from the image sensor to the subject.

Design and specifications are subject to change without notice.

- Manufactured under license from Dolby Laboratories.

Specifications (Continued)

On trademarks

- “NXCAM” logo is a trademark of Sony Corporation.
- “AVCHD Progressive” and “AVCHD Progressive” logotype are trademarks of Panasonic Corporation and Sony Corporation.
- “Memory Stick,”  “Memory Stick Duo,” “MEMORY STICK DUO,” “Memory Stick PRO Duo,” “MEMORY STICK PRO DUO,” “Memory Stick PRO-HG Duo,” “MEMORY STICK PRO-HG DUO,” “MagicGate,” “MAGICGATE,” “MagicGate Memory Stick” and “MagicGate Memory Stick Duo” are trademarks of Sony Corporation.
- “InfoLITHIUM” is a trademark of Sony Corporation.
- “BRAVIA” is a trademark of Sony Corporation.
- Blu-ray Disc™ and Blu-ray™ are trademarks of the Blu-ray Disc Association.
- Dolby and the double-D symbol are trademarks of Dolby Laboratories.
- Microsoft, Windows, and Windows Vista are trademarks or registered trademarks of U.S. Microsoft Corporation in the U.S. and other countries.
- Mac and Mac OS are registered trademarks of Apple Inc. in the U.S. and other countries.
- HDMI, HDMI logo, and High-Definition Multimedia Interface are registered trademarks of HDMI Licensing LLC in the United States and other countries.
- Intel, Intel Core, and Pentium are trademarks or registered trademarks of Intel Corporation or its subsidiaries in the United States and other countries.
- Adobe, the Adobe logo, and Adobe Acrobat are either registered trademarks or trademarks of Adobe Systems Incorporated in the United States and/or other countries.
- SDXC logo is a trademark of SD-3C, LLC.
- MultiMedia Card is a trademark of MultiMediaCard Association.

All other product names mentioned herein may be the trademarks or registered trademarks of their respective companies. Furthermore, ™ and “®” are not mentioned in each case in this manual.

Notes on the License

ANY USE OF THIS PRODUCT OTHER THAN CONSUMER PERSONAL USE IN ANY MANNER THAT COMPLIES WITH THE MPEG-2 STANDARD FOR ENCODING VIDEO INFORMATION FOR PACKAGED MEDIA IS EXPRESSLY PROHIBITED WITHOUT A LICENSE UNDER APPLICABLE PATENTS IN THE MPEG-2 PATENT PORTFOLIO, WHICH LICENSE IS AVAILABLE FROM MPEG LA, L.L.C., 250 STEELE STREET, SUITE 300, DENVER, COLORADO 80206.

THIS PRODUCT IS LICENSED UNDER THE AVC PATENT PORTFOLIO LICENSE FOR THE PERSONAL AND NON-COMMERCIAL USE OF A CONSUMER TO

(i) ENCODE VIDEO IN COMPLIANCE WITH THE AVC STANDARD (“AVC VIDEO”)

AND /OR

(ii) DECODE AVC VIDEO THAT WAS ENCODED BY A CONSUMER ENGAGED IN A PERSONAL AND

NON-COMMERCIAL ACTIVITY AND/OR WAS OBTAINED FROM A VIDEO PROVIDER LICENSED TO PROVIDE AVC VIDEO.

NO LICENSE IS GRANTED OR SHALL BE IMPLIED FOR ANY OTHER USE.

ADDITIONAL INFORMATION MAY BE OBTAINED FROM MPEG LA, L.L.C.

SEE <[HTTP://WWW.MPEGLA.COM](http://WWW.MPEGLA.COM)>

Software is installed in your camcorder. We provide this software based on the license agreements of the copyright owners. Based on requests by the owners of copyright of these software applications, we have an obligation to inform you of the following.

Please read the files in the “LICENSE” folder on the CD-ROM. You will find licenses (in English) for the software.

On GNU GPL/LGPL applied software

The software that is eligible for the following GNU General Public License (hereinafter referred to as “GPL”) or GNU Lesser General Public License (hereinafter referred to as “LGPL”) are included in the camcorder.

This informs you that you have a right to have access to, modify, and redistribute source code for these software programs under the conditions of the supplied GPL/LGPL.

Source code is provided on the web. Use the following URL to download it. When downloading the source code, select NEX-FS700 as the model for your camcorder.

<http://www.sony.net/Products/Linux/>

We would prefer you do not contact us about the contents of source code.

Please read the files in the “LICENSE” folder on the CD-ROM. You will find licenses (in English) for the software.

Index

Numeric

24p/30p OUTPUT	92
25p OUTPUT	93
60i/50i SEL.....	103

A

AC Adaptor	20
AE SHIFT.....	89, 112
AF MICRO ADJUSTMENT	91
AGC LIMIT	89
AMOUNT	91
AREA SET	102
ASPECT	96
ASSIGN BUTTON	64
AUDIO LEVEL DISPLAY	97
AUDIO LIMIT	94
AUDIO SET menu	94
AUTO ISO LIMIT	89

B

Battery	19
BEEP	102
BLACK BALANCE.....	48
BLACK GAMMA.....	58
BLACK LEVEL.....	58
Button-type lithium battery	11

C

CALIBRATION	127
CAMERA DATA DISPLAY	97
CAMERA PROFILE.....	101
CAMERA SET menu	88
CENTER	96
Charge lamp	19
Charger	19
Charging time	20
CLEAR ALL	91

CLOCK SET	28
COLOR BAR.....	91, 112
COLOR DEPTH	60
COLOR LEVEL	59
COLOR MODE	59
COLOR PHASE	60
Connect	

Computer	107
External media device	104
Recorder	106
TV	72

COPY	78
------------	----

D

Data code	70
Date and time	13, 29
DATE REC	102
DELETE	77
DETAIL	61
DISPLAY OUTPUT.....	98
DISPLAY SET menu.....	95
DIVIDE.....	76
DOWN CONVERT TYPE	93

E

Expanded focus.....	38
EXPANDED FOCUS MAG	97

F

FACE DETECTION.....	39
Flash memory unit	32
Focus.....	37
FOCUS DISPLAY	98
Focus hold.....	38
FOCUS TRANSITION.....	90
Focus transition.....	40
FREE RUN	100

G

Gain	44
GAIN SET	88
GAIN/ISO SEL	88
GAMMA	58
GUIDEFRAAME.....	97

H

HD AUDIO FORMAT.....	94
HD REC FORMAT.....	42
HD SIMULTANEOUS REC	34
HDMI TC OUT	93
HD/SD SET	43
Headphone.....	55
HEADPHONE OUT	94
HISTOGRAM	95
HOLD SW MODE.....	103

I

Image database file.....	81
IMAGE SIZE	43
“InfoLITHIUM” battery pack	124
INPUT1 TRIM	94
INPUT1 WIND	94
INPUT2 TRIM	94
INPUT2 WIND	94
IRIS	43
ISO sensitivity	44
ISO SET	88
Items	84

K

KNEE	59
------------	----

L

LANGUAGE.....	102
Large eyecup	30
Last Scene Review	63
LCD BRIGHT	98

Lens21, 127

M

MARKER96, 112

MEDIA FORMAT80

MEDIA SELECT35

Memory card.....31, 123

 Insert/Eject.....31

“Memory Stick” media
.....124

“Memory Stick PRO Duo”
media124

Menu84

 AUDIO SET menu94

 CAMERA SET menu88

 DISPLAY SET menu
.....95

 Items84

 OTHERS menu.....101

 REC/OUT SET menu92

 TC/UB SET menu99

 Using82

MIC+48V54

Moisture condensation.....126

Mount adaptor.....23

Movie.....33

N

ND filter.....46

Number of recordable photos
.....120

O

OPERATION TIME.....103

OTHERS menu101

Output resolution73

OUTPUT SELECT.....92

Outside power source20

P

PEAKING96, 112

PHOTO CAPTURE.....79

Picture profile.....56

Playback66

Power cord (mains lead)20

Pre-installed rechargeable
battery.....128

PROTECT75

Push auto focus38

R

REC LAMP[F]102

REC LAMP[R]102

REC LINK90

REC RUN100

REC SET.....92

Recording33

Recording format42

Recording image quality43

Recording time119

REC/OUT SET menu.....92

REMOTE CONTROL103

REPAIR IMAGE DB FILE
.....81

RESET button9

S

SAFETY ZONE.....96

Screen indicators12

SD WIDE CONVERT93

SD WIDE REC92

SDI/HDMI/COMPONENT
.....92

Self-diagnosis display117

SHUTTER DISPLAY.....98

Shutter speed45

Simultaneous recording.....34

SLOW & QUICK.....49

Slow & Quick Motion.....49

Specifications129

SPOT FOCUS39

START TIMER.....90

Status check.....71

STEADYSHOT90

Still image.....35, 79

SUMMERTIME102

SUPER SLOW MOTION50

Super Slow Motion.....50

Supplied items17

S&Q BUTTON SETTING
.....101

S&Q MOTION49

T

TC FORMAT99

TC MAKE100

TC PRESET.....62, 112

TC RUN.....100

TC/UB SET menu99

TONE91

Trademark.....132

TRANSITION TIME90

Transmitter11

Troubleshooting.....109

TV72

U

UB PRESET62

UB TIME REC100

USB CONNECT103

Using your camcorder abroad
.....121

V

VERSION DISPLAY103

VIDEO OUT92

Viewfinder lens adjustment
ring.....30

Volume68

W

Warning indicators117

Warning messages118

WB OUTDOOR LEVEL89

Index (Continued)

WB PRESET	89
WB SHIFT	60
WB TEMP SET	89
White balance	47
Wireless Remote Commander	11

X

XLR AGC LINK	94
XLR SET	94

Z

ZEBRA	96, 112
ZOOM DISPLAY	98
Zooming	36

<http://www.sony.net/>

Printed on 70% or more recycled paper using VOC (Volatile Organic Compound)-free vegetable oil based ink.

© 2012 Sony Corporation

Printed in Japan

