

**datavideo**

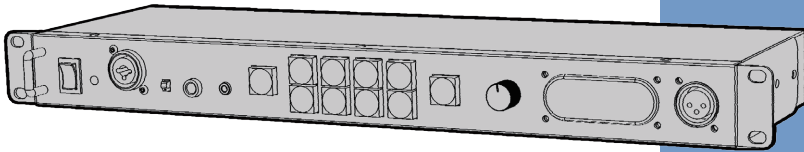

**INTERCOM SYSTEM**

**ITC-100**

**Instruction Manual**

[www.datavideo.com](http://www.datavideo.com)

# Table of Contents

<b>FCC COMPLIANCE STATEMENT</b> .....	<b>4</b>
<b>WARNINGS AND PRECAUTIONS</b> .....	<b>4</b>
<b>WARRANTY</b> .....	<b>5</b>
STANDARD WARRANTY.....	5
THREE YEAR WARRANTY .....	5
<b>DISPOSAL</b> .....	<b>6</b>
<b>1. PRODUCT OVERVIEW</b> .....	<b>7</b>
FEATURES .....	7
SYSTEM DIAGRAM .....	8
<b>2. CONNECTIONS AND CONTROLS</b> .....	<b>9</b>
FRONT PANEL.....	9
REAR PANEL.....	11
<b>3. ITC-100SL BELT PACK</b> .....	<b>12</b>
<b>4. ADDITIONAL CABLE PURCHASE</b> .....	<b>14</b>
5 PIN XLR EXTENSION CABLE (CB-3 / CB-4).....	14
3.5MM MINI-PLUG TO 4-PIN XLR MALE ADAPTER CABLE.....	14
<b>5. EXAMPLE SYSTEM SETUP</b> .....	<b>15</b>
SETTING UP THE SE-500 WITH THE ITC-100 .....	15
SETTING UP THE SE-500HD WITH THE ITC-100 .....	16
SETTING UP THE SE-650 WITH THE ITC-100 .....	17
SETTING UP THE SE-700 WITH THE ITC-100 .....	18
SETTING UP THE SE-2200 WITH THE ITC-100 .....	19
SETTING UP THE SE-2850 WITH THE ITC-100 .....	20
<b>6. ITC-100 TALLY INPUT</b> .....	<b>21</b>
TALLY A INPUT PIN DEFINITION .....	21
TALLY B INPUT PIN DEFINITION.....	21
<b>7. SPECIFICATIONS</b> .....	<b>22</b>
<b>SERVICE &amp; SUPPORT</b> .....	<b>24</b>

**Disclaimer of Product & Services**

The information offered in this instruction manual is intended as a guide only. At all times, Datavideo Technologies will try to give correct, complete and suitable information. However, Datavideo Technologies cannot exclude that some information in this manual, from time to time, may not be correct or may be incomplete. This manual may contain typing errors, omissions or incorrect information. Datavideo Technologies always recommend that you double check the information in this document for accuracy before making any purchase decision or using the product. Datavideo Technologies is not responsible for any omissions or errors, or for any subsequent loss or damage caused by using the information contained within this manual. Further advice on the content of this manual or on the product can be obtained by contacting your local Datavideo Office or dealer.

# FCC Compliance Statement

This device complies with part 15 of the FCC rules. Operation is subject to the following two conditions:

- (1) This device may not cause harmful interference, and
- (2) This device must accept any interference received, including interference that may cause undesired operation.



## Warnings and Precautions

1. Read all of these warnings and save them for later reference.
2. Follow all warnings and instructions marked on this unit.
3. Unplug this unit from the wall outlet before cleaning. Do not use liquid or aerosol cleaners. Use a damp cloth for cleaning.
4. Do not use this unit in or near water.
5. Do not place this unit on an unstable cart, stand, or table. The unit may fall, causing serious damage.
6. Slots and openings on the cabinet top, back, and bottom are provided for ventilation. To ensure safe and reliable operation of this unit, and to protect it from overheating, do not block or cover these openings. Do not place this unit on a bed, sofa, rug, or similar surface, as the ventilation openings on the bottom of the cabinet will be blocked. This unit should never be placed near or over a heat register or radiator. This unit should not be placed in a built-in installation unless proper ventilation is provided.
7. This product should only be operated from the type of power source indicated on the marking label of the AC adapter. If you are not sure of the type of power available, consult your Datavideo dealer or your local power company.
8. Do not allow anything to rest on the power cord. Do not locate this unit where the power cord will be walked on, rolled over, or otherwise stressed.
9. If an extension cord must be used with this unit, make sure that the total of the ampere ratings on the products plugged into the extension cord do not exceed the extension cord rating.
10. Make sure that the total amperes of all the units that are plugged into a single wall outlet do not exceed 15 amperes.
11. Never push objects of any kind into this unit through the cabinet ventilation slots, as they may touch dangerous voltage points or short out parts that could result in risk of fire or electric shock. Never spill liquid of any kind onto or into this unit.
12. Except as specifically explained elsewhere in this manual, do not attempt to service this product yourself. Opening or removing covers that are marked "Do Not Remove" may expose you to dangerous voltage points or other risks, and will void your warranty. Refer all service issues to qualified service personnel.
13. Unplug this product from the wall outlet and refer to qualified service personnel under the following conditions:
  - a. When the power cord is damaged or frayed;
  - b. When liquid has spilled into the unit;
  - c. When the product has been exposed to rain or water;
  - d. When the product does not operate normally under normal operating conditions. Adjust only those controls that are covered by the operating instructions in this manual; improper adjustment of other controls may result in damage to the unit

and may often require extensive work by a qualified technician to restore the unit to normal operation;

- e. When the product has been dropped or the cabinet has been damaged;
- f. When the product exhibits a distinct change in performance, indicating a need for service.

## Warranty

### Standard Warranty

- Datavideo equipment is guaranteed against any manufacturing defects for one year from the date of purchase.
- The original purchase invoice or other documentary evidence should be supplied at the time of any request for repair under warranty.
- The product warranty period begins on the purchase date. If the purchase date is unknown, the product warranty period begins on the thirtieth day after shipment from a Datavideo office.
- All non-Datavideo manufactured products (product without Datavideo logo) have only one year warranty from the date of purchase.
- Damage caused by accident, misuse, unauthorized repairs, sand, grit or water is not covered under warranty.
- Viruses and malware infections on the computer systems are not covered under warranty.
- Any errors that are caused by unauthorized third-party software installations, which are not required by our computer systems, are not covered under warranty.
- All mail or transportation costs including insurance are at the expense of the owner.
- All other claims of any nature are not covered.
- All accessories including headphones, cables, batteries, metal parts, housing, cable reel and consumable parts are not covered under warranty.
- Warranty only valid in the country or region of purchase.
- Your statutory rights are not affected.

### Three Year Warranty

- All Datavideo products purchased after July 1st, 2017 are qualified for a free two years extension to the standard warranty, providing the product is registered with Datavideo within 30 days of purchase.
- 
- The logo is a black rectangular box with rounded corners. At the top, it says "Register for" in white. Below that, "3 year" is written in a large, bold, white font, with "year" stacked on top of "warranty". At the bottom, the website "www.datavideo.com" is written in a smaller white font.
- Certain parts with limited lifetime expectancy such as LCD panels, DVD drives, Hard Drive, Solid State Drive, SD Card, USB Thumb Drive, Lighting, Camera module, PCIe Card are covered for 1 year.
  - The three-year warranty must be registered on Datavideo's official website or with your local Datavideo office or one of its authorized distributors within 30 days of purchase.

## Disposal

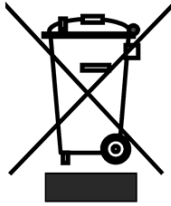

### For EU Customers only - WEEE Marking

This symbol on the product or on its packaging indicates that this product must not be disposed of with your other household waste. Instead, it is your responsibility to dispose of your waste equipment by handing it over to a designated collection point for the recycling of waste electrical and electronic equipment. The separate collection and recycling of your waste equipment at the time of disposal will help to conserve natural resources and ensure that it is recycled in a manner that protects human health and the environment. For more

information about where you can drop off your waste equipment for recycling, please contact your local city office, your household waste disposal service or the shop where you purchased the product.



**CE Marking** is the symbol as shown on the left of this page. The letters "CE" are the abbreviation of French phrase "Conformité Européenne" which literally means "European Conformity". The term initially used was "EC Mark" and it was officially replaced by "CE Marking" in the Directive 93/68/EEC in 1993. "CE Marking" is now used in all EU official documents.

# 1. Product Overview

The ITC-100 is a 19" Rack Mount 8 Channel Intercom / Talkback System. It incorporates tally indicators for each channel and individual channel call buttons. The **ALL** button enables the feature that allows the director to communicate with all channels.

The ITC-100 is designed for communication purpose in a live mixing environment and allows easy bi-directional communication between the director and other members of the crew.

It is a perfect communication system for Datavideo SE-500, SE-500HD, SE-650, SE-700, SE-2200 and SE-2850 video mixers.

## Features

### Front Panel

- Combined XLR and 1/4' (6.3 mm) microphone input
- Dynamic / Condenser microphone selection switch
- 1/4' (6.3mm) Jack for Headphones without microphone
- 3.5mm Jack for Headset with microphone
- Speaker with volume control knob
- Channel buttons 1 – 8 for communicating with individual channels.
- ALL button to activate communication with all channels.
- Base Unit MUTE button

### Rear Panel

- 8 x 5pin XLR connectors for cable connection to ITC-100SL Belt Packs.  
**Additional cable purchase:** CB-3 is a 20m 5pin XLR Male to XLR Female cable which allows cable connection to the ITC-100SL of up to 200m.
- 2 x 15pin D Sub Tally Input sockets for tally communication from the switcher to tally light box.

### ITC-100SL Belt Pack for Crew members

- Call Button for sending paging signal to Base Unit
- Press and hold the **Talk** button to communicate with the director on the Base Unit end.
- Headset volume control knob
- Bi-Color Tally LED on Belt Pack Unit
- TD-2/3 Camera Tally Indicator connected to the Belt Pack

# System Diagram

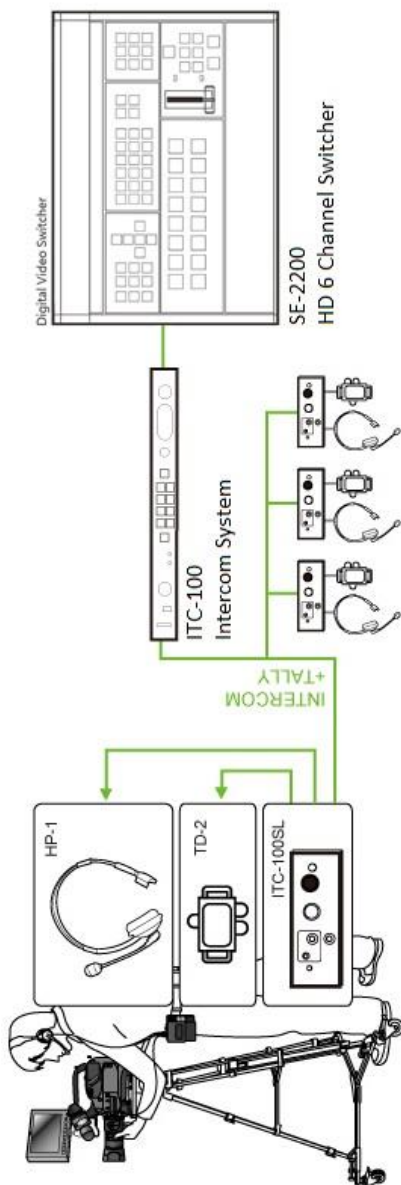



## 2. Connections and Controls

### Front Panel

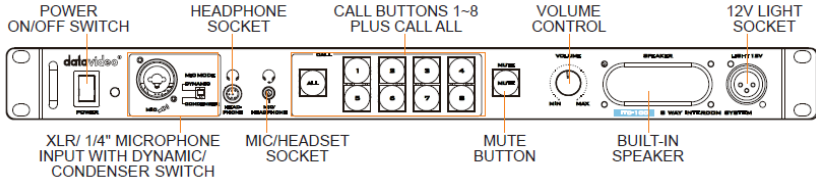

#### On/Off Switch

Powers the ITC-100 On / Off. Red LED indicates that unit is switched on.

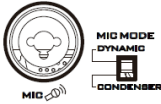

#### XLR Microphone Socket

Combined XLR / 1/4" (6.3mm) Microphone Input Jack for either a Condenser or Dynamic Gooseneck Microphone.

- XLR supports Condenser Microphones
- 1/4" (6.3mm) Jack supports Dynamic Gooseneck Microphone (Supplied).



#### Headphone Socket

1/4" (6.3mm) Stereo Headphone Socket for conventional headphones. Plugging in headphones will disable the built-in speaker.



#### Microphone / Headset Socket

3.5mm Stereo Socket for Microphone Headset.

**Note: Plugging in a Microphone Headset will disable the built-in speaker and the XLR Microphone Input.**



#### ALL Button

Opens communication with all channels.

**Note: All channels will hear communication from the operator, or from any other channels using the ITC-100SL Belt Pack's TALK button.**

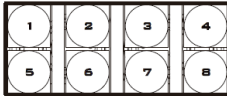

### Channel Buttons 1~8

Opens communication with individual channels. More than 1 channel can be active at any given time, active channels are illuminated red.

All active channels will hear communication from the operator or from any other active channels. The buttons will also indicate if any channel is paging, the paging channel will flash in orange until the page is answered.



### Mute Button

Mutes all communication from the base station or any other channels.

**NOTE: If any channel uses the CALL button, the paging tone will still sound even when the MUTE button is active.**



### Volume Control

Controls the volume of the built-in speaker or audio output to the headphone or MIC headset (whichever is connected).

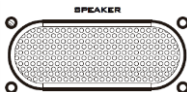

### Built-In Speaker

Sounds audible alert when a channel is paging and provides audio during talkback conversations.

**Note: Speaker is disabled when headphone or MIC headset is connected to the ITC-100.**



### 12V Light Socket

12V light socket for powering the connected gooseneck light (supplied).

## Rear Panel

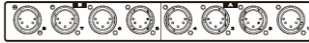
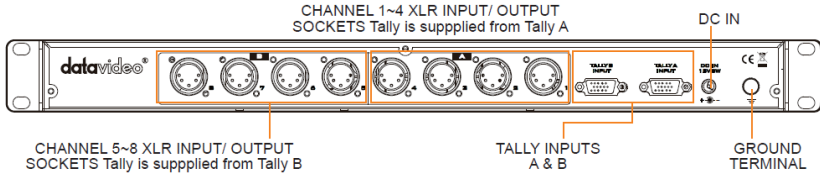

### Channel Input/Output XLR Ports

Each of the 8 channels has an XLR connector that carries bi-directional signals between the ITC-100 and the ITC-100SL. **Power, tally and bi-directional audio are all carried though the same 5 PIN XLR to XLR cable (supplied).**



### Tally Inputs A & B

Tally Inputs A & B provide direct connection to the Datavideo switcher. They supply bi-color tally information to the ITC-100SL; RED indicates Live and GREEN indicates Cued.

Tally Input A carries bicolor tally information of Channels 1 ~ 4 and Tally Input B carries bicolor tally information of Channels 5 ~ 8.

**DC IN  
12V 8W**



### DC Power Input 12V 8W

DC in socket connects the supplied 12V / 8W PSU. The connection can be secured by screwing the outer fastening ring of the DC In plug to the socket.

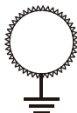





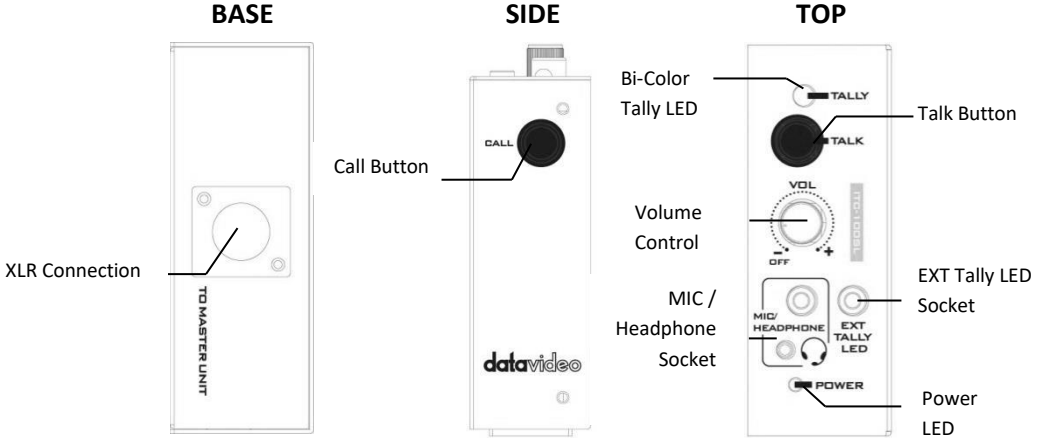

### Ground Terminal

When connecting this unit to any other component, make sure that it is properly grounded by connecting this terminal to an appropriate point. When connecting, use the socket and be sure to use wire with a cross-sectional area of at least 1.0 mm<sup>2</sup>.

### 3. ITC-100SL Belt Pack



 <p><b>XLR Connection</b> Connects the ITC-100SL to the ITC-100 Base Unit. <b>Power, tally and bi-directional audio are all carried through the same 5 PIN XLR to XLR cable (supplied).</b></p>	 <p><b>MIC / Headphone Socket</b> The ITC-100SL has both a 3.5mm MIC socket and a 2.5mm Headset socket. The user is allowed to use a standard 3.5mm MIC / Headset, or a Motorola type 2.5mm MIC / Headset if preferred.</p>
 <p><b>Call Button</b> Sends a paging message to the ITC-100 Base Unit. The channel button will flash orange and there will be an audible tone each time the button is pressed.</p>	 <p><b>External Tally LED Socket</b> An external tally LED (TD-2/3) can be connected to the ITC-100SL via a GPI cable. This enables the tally light to be positioned in a more visible place, such as on top of the camera. When the channel is LIVE, the LED will be RED, and when the channel is CUED, the LED will be GREEN.</p>
 <p><b>Bi-Color Tally LED</b> Illuminates RED when the channel is LIVE and GREEN when the channel is CUED.</p>	<p><b>NOTE: The Tally LED on the ITC-100SL will continue to operate as normal even after a TD-2/3 has been connected.</b></p>
 <p><b>Talk Button</b> Opens up talkback communication with the ITC-100 Base Unit, and any other active channels.</p>	

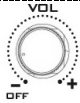

### **Volume Control**

Adjusts the volume of the headphones.



### **Power LED**

The Power LED will be turned ON when the channel is active. The channel can be activated by pressing the individual channel button 1-8, or the ALL button.

**NOTE: The tally LED will continue to work even when the Power LED is not ON, and the channel is not active.**

## 4. Additional Cable Purchase

### 5 PIN XLR Extension Cable (CB-3 / CB-4)

To extend the reach of the ITC-100SL Belt Pack from the ITC-100 Base Unit, Datavideo provides pre-manufactured XLR cables such as CB-3 and CB-4. The table below lists the respective lengths of the CB-3 and CB-4.

	Length
CB-3	20 m
CB-4	50 m

Please contact your local dealer for price and availability of the CB-3 and CB-4 cables.

#### ITC-100 XLR Cable PIN Assignments

PIN	Cable	Signal Assignment
1	Red	Tally Red
2	Black	Talk & Call
3	Shield	Common Ground
4	Green	+12V DC power to ITC-100SL
5	White	Tally Green

Note: 5 PIN XLR Cable is a straight through cable (PIN-to-PIN).

### 3.5mm Mini-Plug to 4-Pin XLR Male Adapter Cable

For connecting an XLR4 professional headset to the 3.5mm socket on the ITC-100SL Belt Pack, Datavideo provides a 3.5mm Mini-Plug to 4-Pin XLR Male Cable which is available through separate purchase.

**Note:** Please contact your dealer or local Datavideo office for more information on the **3.5mm Mini-Plug to 4-Pin XLR Male Microphone Cable**.

If the headset comes with an electret condenser microphone, then the tip of PIN 2 of the XLR connector should connect a 1uF capacitor for AC coupling.

3.5mm Mini-Plug	XLR Male Connector	Signal Assignment
Tip	PIN 2	Dynamic or Electret Condenser Microphone
Ring	PIN 4	Earphone (Impedance range of 8-100Ω, ideally 30-40 Ω)
Ground/Sleeve	PIN 1 & 3	Common Ground

## 5. Example System Setup

### Setting up the SE-500 with the ITC-100

The SE-500 is a four channel video switcher. To set up the SE-500 with the ITC-100, you will need to purchase a 15pin Female D Sub to 15pin Male D Sub Tally Cable (Part No.: G07690150018) from Datavideo.

By using the tally cable, the Tally Output of the SE-500 can be connected to either the ITC-100 Tally Input A or Tally Input B. The Tally Input A carries bicolor tally information of Channels 1-4 (denoted by A on the rear panel of the ITC-100) and the Tally Input B carries bicolor tally information of Channels 5-8 (denoted by B on the rear panel of the ITC-100).

The channel connections to the respective ITC-100SL Belt Packs are depicted in the diagram below.

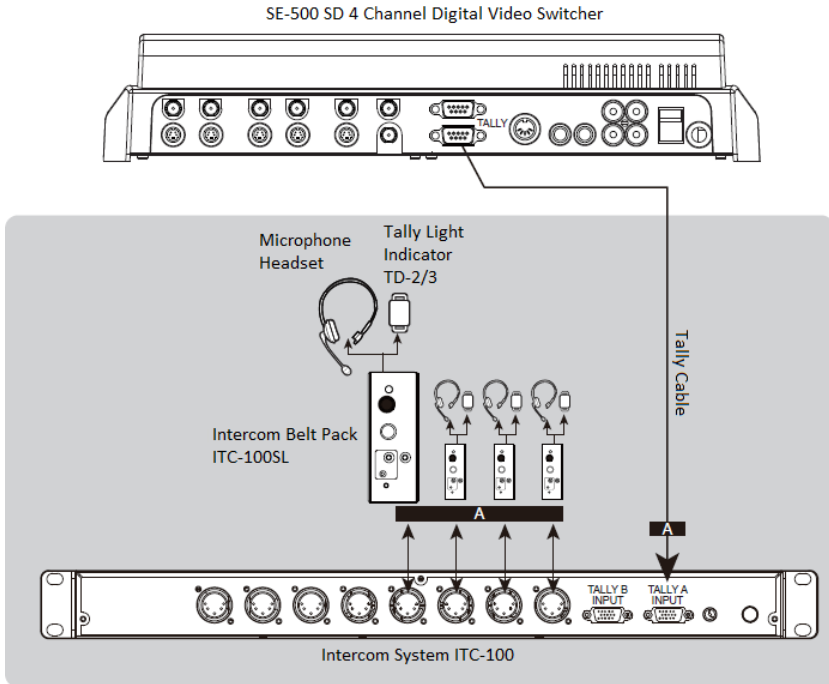

## Setting up the SE-500HD with the ITC-100

The SE-500HD is a four channel video switcher. To set up the SE-500HD with the ITC-100, you will need to purchase a 15pin Female D Sub to 15pin Male D Sub Tally Cable (Part No.: G07690150018) from Datavideo.

By using the tally cable, the Tally Output of the SE-500HD can be connected to either the ITC-100 Tally Input A or Tally Input B. The Tally Input A carries bicolor tally information of Channels 1-4 (denoted by A on the rear panel of the ITC-100) and the Tally Input B carries bicolor tally information of Channels 5-8 (denoted by B on the rear panel of the ITC-100).

The channel connections to the respective ITC-100SL Belt Packs are depicted in the diagram below.

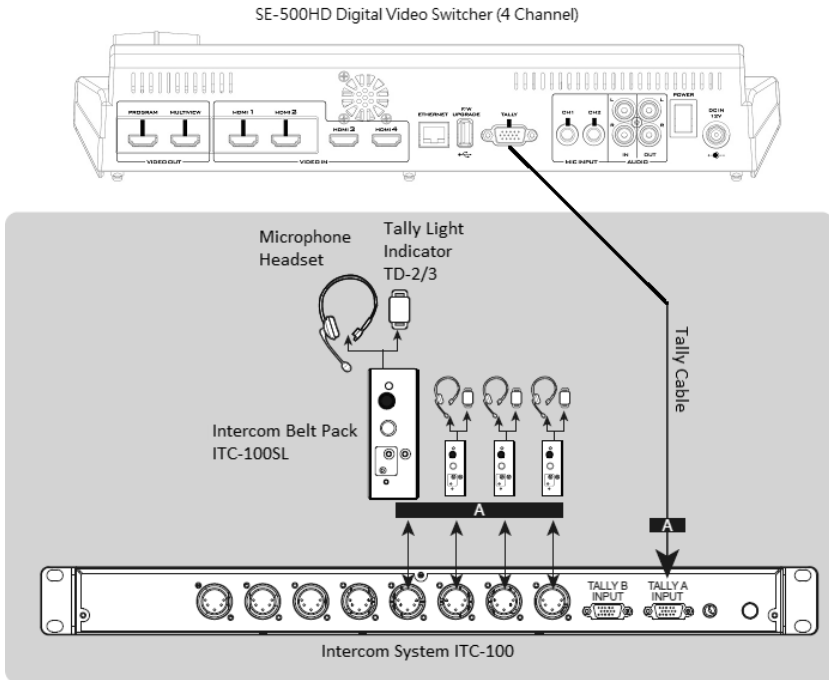



## Setting up the SE-650 with the ITC-100

The SE-650 is a four channel video switcher. To set up the SE-650 with the ITC-100, you will need to purchase a 15pin Female D Sub to 15pin Male D Sub Tally Cable (Part No.: G07690150018) from Datavideo.

By using the tally cable, the Tally Output of the SE-650 can be connected to either the ITC-100 Tally Input A or Tally Input B. The Tally Input A carries bicolor tally information of Channels 1-4 (denoted by A on the rear panel of the ITC-100) and the Tally Input B carries bicolor tally information of Channels 5-8 (denoted by B on the rear panel of the ITC-100).

The channel connections to the respective ITC-100SL Belt Packs are depicted in the diagram below.

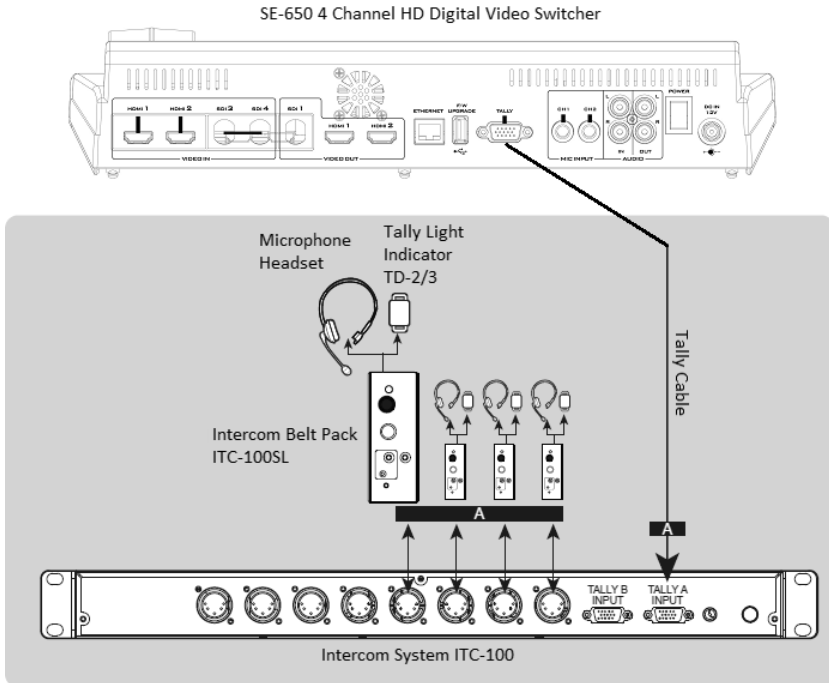

## Setting up the SE-700 with the ITC-100

The SE-700 is a four channel video switcher. To set up the SE-700 with the ITC-100, you will need to purchase a 15pin Female D Sub to 15pin Male D Sub Tally Cable (Part No.: G07690150018) from Datavideo.

By using the tally cable, the Tally Output of the SE-700 can be connected to either the ITC-100 Tally Input A or Tally Input B. The Tally Input A carries bicolor tally information of Channels 1-4 (denoted by A on the rear panel of the ITC-100) and the Tally Input B carries bicolor tally information of Channels 5-8 (denoted by B on the rear panel of the ITC-100).

The channel connections to the respective ITC-100SL Belt Packs are depicted in the diagram below.

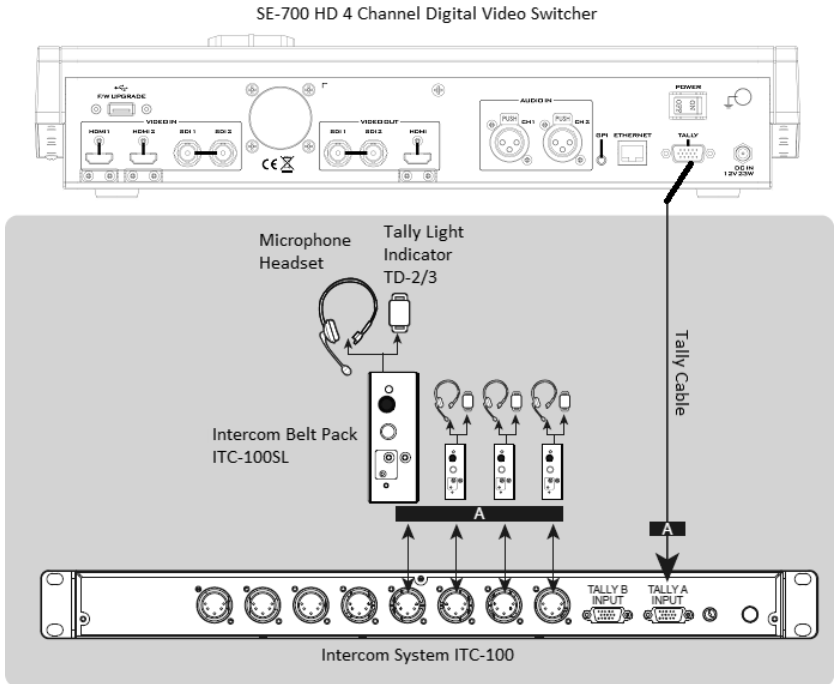

## Setting up the SE-2200 with the ITC-100

The SE-2200 is a six channel video switcher. To set up the SE-2200 with the ITC-100, you will need to purchase a CB-28 25pin Male D Sub to 4 x 15pin Male D Sub Tally Cable (Part No.: G07690250002) from Datavideo.

By using the tally cable, the Tally Output of the SE-2200 can be connected to the ITC-100 Tally Input A **AND** Tally Input B. The Tally Input A carries bicolor tally information of Channels 1-4 (denoted by A on the rear panel of the ITC-100) and the Tally Input B carries bicolor tally information of Channels 5-8 (denoted by B on the rear panel of the ITC-100).

The channel connections to the respective ITC-100SL Belt Packs are depicted in the diagram below.

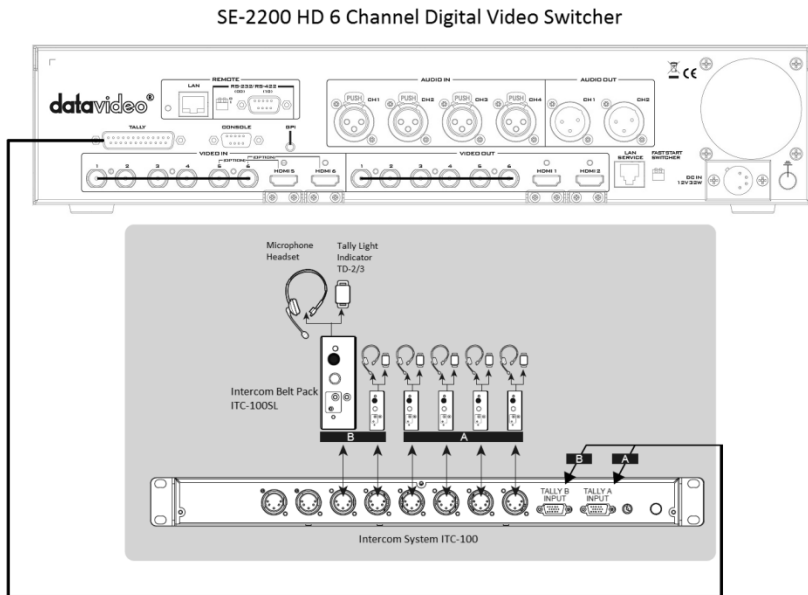

## Setting up the SE-2850 with the ITC-100

The SE-2850 is an 8/12 channel video switcher. To set up the SE-2850 with the ITC-100, you will need to purchase a CB-28 25pin Male D Sub to 4 x 15pin Male D Sub Tally Cable (Part No.: G07690250002) from Datavideo.

By using the tally cable, the Tally Output of the SE-2850 can be connected to the ITC-100 Tally Input A **AND** Tally Input B. The Tally Input A carries bicolor tally information of Channels 1-4 (denoted by A on the rear panel of the ITC-100) and the Tally Input B carries bicolor tally information of Channels 5-8 (denoted by B on the rear panel of the ITC-100).

The channel connections to the respective ITC-100SL Belt Packs are depicted in the diagram below.

SE-2850 HD 8/12 Channel Digital Video Switcher

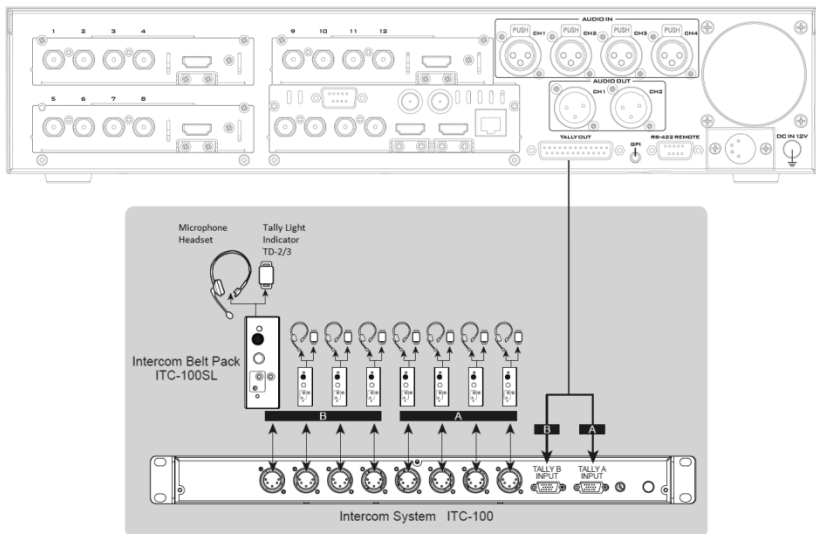

## 6. ITC-100 Tally Input

If you are using the ITC-100 with a Datavideo product, you do not need to worry about tally information, as it has already been customized for the ITC-100.

However, if you are using the ITC-100 with equipment of other manufacturers, please see the following tables for PIN definitions of the ITC-100 Tally A and B inputs.

Contact closure between a tally PIN and the ground will turn ON the Tally LED. For example, on Tally Input A, if the connection between PIN 1 and PIN 4 is closed, RED Tally LED on Channel 1 will be turned ON; if the connection between PIN 13 and PIN 4 is closed, GREEN Tally LED on Channel 3 will be turned ON.

### Tally A Input PIN Definition

Tally A Input carries Tally Information of Channels 1-4. The following table shows the PIN definitions for each channel.

Video Channel	Red LED LIVE (On Air)	Green LED CUED (Next)
1	PIN 1	PIN 3
2	PIN 6	PIN 8
3	PIN 11	PIN 13
4	PIN 5	PIN 15

PINs 4/9/14 are ground pins.



### Tally B Input PIN Definition

Tally B Input carries Tally Information of Channels 5-8. The following table shows the PIN definitions for each channel:

Video Channel	Red LED LIVE (On Air)	Green LED CUED (Next)
5	PIN 1	PIN 3
6	PIN 6	PIN 8
7	PIN 11	PIN 13
8	PIN 5	PIN 15

PINs 4/9/14 are ground pins.

## 7. Specifications

ITC-100 Base Unit		Specifications
Input / Output	<b>Power</b>	12 V / 1A (8 W)
	<b>Tally</b>	2 x 15 PIN DSub Sockets for Tally A and B
	<b>Input</b>	5 PIN XLR Connector x 8 (PIN 1: Tally_RED; PIN 2: Tip; PIN 3: GND; PIN 4: +12V; PIN 5: Tally_GREEN)
	<b>MIC / Headset</b>	3.5 mm Stereo Jack Socket for Headphone / Microphone combination. Headset Impedance 8-600 Ohms 100 mW (min).  <b>Pin definition</b> Tip: Mic; Ring: Phone; Sleeve: GND
	<b>Headphone</b>	¼" (6.3mm) Stereo Headphone Socket Headset Impedance 8-600 Ohms 100 mW (min).  <b>Pin definition</b> Tip: Mic; Ring: Phone; Sleeve: GND
		
		
	<b>Light Socket (DC 12 V)</b>	3 PIN XLR Connector PIN 2: 12V PIN 3: GND Light Power Consumption: 12 V / 100 mA (MAX.)
	<b>Microphone</b>	3 PIN XLR / ¼" (6.3mm) Jack Microphone Socket PIN 1: N/A PIN 2: MIC (5V output to microphone) PIN 3: GND Switchable Condenser / Dynamic Input Microphone Level -67 dB
<b>Frequency Response</b>		550-3.6 kHz, <+/- 3dB
<b>THD</b>		< 3%
<b>S/N</b>		> 50dB

<b>Built-in Speaker</b>	70mm x 30mm 32 Ohm 3 Watts
<b>Operating Range</b>	Up to 200 meters between base station and slave
<b>Operating Temp. Range</b>	5 – 45 °C
<b>Dimensions</b>	1U height 19" rack W: 440 mm x D: 130 mm x H: 40mm
<b>Weight</b>	1.9 kg
<b>ITC-100SL Belt Pack Unit</b>	<b>Specifications</b>
<b>Input</b>	5 PIN XLR Connector (PIN 1: Tally_RED; PIN 2: Tip; PIN 3: GND; PIN 4: +12V; PIN 5: Tally_GREEN)
<b>MIC / Headset Socket</b>	3.5 mm Stereo Jack Socket for Headphone / Microphone Headset Impedance 8 - 600 Ohms 100 mW (Min.). Microphone Level -67 dB Or 2.5 mm Stereo Jack Socket for Motorola Mobile Phone type headset / microphone.  <b>Pin definition</b> Tip: Mic; Ring: Phone; Sleeve: GND  
<b>Tally OUT Socket</b>	3.5 mm Jack Socket to connect to TD-2 or TD-3 tally indicator.
<b>Tally LED</b>	Bi-color LED – RED indicates LIVE / GREEN indicated CUED
<b>Power LED</b>	Illuminates to indicate that power is being received.
<b>Operating Range</b>	Up to 200 meters between Base Station and Slave.
<b>Operating Temp. Range</b>	5 – 45°C
<b>Dimensions</b>	114 mm x 97 mm x 35 mm
<b>Weight</b>	348 g

## Service & Support

It is our goal to make your products ownership a satisfying experience. Our supporting staff is available to assist you in setting up and operating your system. Please refer to our web site [www.datavideo.com](http://www.datavideo.com) for answers to common questions, support requests or contact your local office below.

**China Shanghai**  
DataVideo Technologies China Co  
601, Building 10 No. 1228,  
Rd. Jiangchang,  
Jingnan District, Shanghai  
Tel: +86 21-5603 6599  
Fax: +86 21-5603 6770  
E-mail: [service@datavideo.cn](mailto:service@datavideo.cn)

**China Beijing**  
DataVideo Technologies China Co  
No. 812, Building B, Wankai Center,  
No.316, Wan Feng Road, Fengtai District,  
Beijing, China  
Tel: +86 10-8586 9034  
Fax: +86 10-8586 9074  
E-mail: [service@datavideo.cn](mailto:service@datavideo.cn)

**China Chengdu**  
DataVideo Technologies China Co  
B-323, Meiliant square, No. 1385,  
Middle of Tianfu Avenue, Gaosin District,  
Chengdu, Sichuan  
Tel: +86 28-8613 7786  
Fax: +86 28-8513 6486  
E-mail: [service@datavideo.cn](mailto:service@datavideo.cn)

**China Fuzhou**  
DataVideo Technologies China Co  
A1-2318-19 Room, No. 8, Aojiang Road,  
Taliang District, Fuzhou, Fujian, China  
Tel: 0591-83211756 · 0591-83210187  
Fax: 0591-93211262  
E-mail: [service@datavideo.cn](mailto:service@datavideo.cn)

**China Jinan**  
DataVideo Technologies China Co  
902, No. 1 business building,  
Xiangtai Square, No. 129,  
Yingxiongshan Road, Shizhong District,  
Jinan City, Shandong Province, China  
Tel: +86 531-8607 8813  
E-mail: [service@datavideo.cn](mailto:service@datavideo.cn)

**Hong Kong**  
DataVideo Hong Kong Ltd  
G/F, 26 Cross Lane,  
Wanchai, Hong Kong  
Tel: +852-2833-1981  
Fax: +852-2833-9916  
E-mail: [info@datavideo.com.hk](mailto:info@datavideo.com.hk)

**India Noida**  
DataVideo India Noida  
A-132, Sec-63, Noida-201307,  
India  
Tel: +91-0120-2427337  
Fax: +91-0120-2427338  
E-mail: [sales@datavideo.in](mailto:sales@datavideo.in)

**India Kochi**  
DataVideo India Kochi  
2nd Floor- North Wing, Govardhan Building,  
Opp. NCC Group Headquarters, Chittoor Road,  
Cochin- 682035  
Tel: +91 4844-025336  
Fax: +91 4844-047696  
E-mail: [sales@datavideo.in](mailto:sales@datavideo.in)

**Netherlands**  
DataVideo Technologies Europe BV  
Floridadreef 106  
3565 AM Utrecht,  
The Netherlands  
Tel: +31-30-261-96-66  
Fax: +31-30-261-96-67  
E-mail: [info@datavideo.nl](mailto:info@datavideo.nl)

**Singapore**  
DataVideo Visual Technology(S) Pte Ltd  
No. 178 Paya Lebar Road #06-07  
Singapore 409030  
Tel: +65-6749 6866  
Fax: +65-6749 3266  
E-mail: [info@datavideovirtualset.com](mailto:info@datavideovirtualset.com)

**Singapore**  
DataVideo Technologies (S) PTE Ltd  
No. 178 Paya Lebar Road #06-03  
Singapore 409030  
Tel: +65-6749 6866  
Fax: +65-6749 3266  
E-mail: [sales@datavideo.sg](mailto:sales@datavideo.sg)

**Taiwan**  
DataVideo Technologies Co. Ltd  
10F, No. 176, Jian 1st Rd., Chung Ho  
District, New Taipei City 235, Taiwan  
Tel: +886-2-8227-2888  
Fax: +886-2-8227-2777  
E-mail: [service@datavideo.com.tw](mailto:service@datavideo.com.tw)

**United States**  
DataVideo Corporation  
7048 Elmer Avenue,  
Whittier, CA 90602,  
U.S.A.  
Tel: +1-562-696 2324  
Fax: +1-562-698 6930  
E-mail: [sales@datavideo.com](mailto:sales@datavideo.com)

**United Kingdom**  
DataVideo UK Limited  
Brookfield House, Brookfield Industrial  
Estate, Peakdale Road, Glossop,  
Derbyshire, SK13 6LQ  
Tel: +44-1457 951 000  
Fax: +44-1457 950 964  
E-mail: [sales@datavideo.co.uk](mailto:sales@datavideo.co.uk)

**France**  
DataVideo France s.a.r.l.  
Cite Descartes 1, rue Albert Einstein  
Champs sur Marne 774477 –  
Marne la Vallée cedex 2  
Tel: +33-1-60370246  
Fax: +33-1-60376732  
E-mail: [info@datavideo.fr](mailto:info@datavideo.fr)



Please visit our website for latest manual update.

[www.datavideo.com/product/ITC-100](http://www.datavideo.com/product/ITC-100)

**datavideo**  
[www.datavideo.com](http://www.datavideo.com)

All the trademarks are the properties of their respective owners.  
DataVideo Technologies Co., Ltd. All rights reserved 2018