

Interchangeable Lens Digital Camera  
ILCE-7M3 α7III

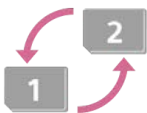

Use this manual if you encounter any problems, or have any questions about your product.



### Auto Switch Media

If you use two memory-card slots, you can automatically switch to recording with the other memory card when the memory card in use becomes full.



### How to tag the location information on the images

You can record the location information on the images. The location information can be acquired via a smartphone.



### ILCE-7M3 Lens compatibility information

This website provides the lens compatibility information. (Another window will open.)

[Names of parts/Icons and indicators](#)

[Names of parts](#)

[Front side](#)



- Rear side >
- Top side/Side view >
- Bottom >
- Lens FE 28-70 mm F3.5-5.6 OSS (Supplied with ILCE-7M3K) >

## Basic operations

- Using the control wheel >
- Using the multi-selector >
- Using MENU items >
- Using the Fn (Function) button >
- How to use the Quick Navi screen >
- How to use the keyboard >

## Icons and indicators

- List of icons on the monitor >
- Switching the screen display (while shooting/during playback) >
- DISP Button (Monitor/Finder) >

## Preparing the camera

### Checking the camera and the supplied items

### Charging the battery pack

- Inserting/removing the battery pack >
- Charging the battery pack while it is inserted in the camera >
- Charging by connecting to a computer >
- Battery life and number of recordable images >
- Supplying power from a wall outlet (wall socket) >
- Notes on the battery pack >
- Notes on charging the battery pack >

### Inserting a memory card (sold separately)

- Inserting/removing a memory card >
- Memory cards that can be used >
- Notes on memory card >

### Attaching a lens

└ Attaching/removing a lens >

└ Attaching the lens hood >

### Attaching accessories

└ Mount Adaptor >

└ LA-EA1/LA-EA3 Mount Adaptor >

└ LA-EA2/LA-EA4 Mount Adaptor >

└ Vertical grip >

### Setting language, date and time

### In-Camera Guide

## Shooting

### Shooting still images

#### Focusing

└ Focus Mode >

#### Auto focus

└ Focus Area >

└ Phase detection AF >

└ Focus Standard >

└ Focus Settings >

└ Adjusting the focus area settings to the camera's orientation (horizontal/vertical) (Sw. V/H AF Area) >

└ AF/MF control >

└ AF w/ shutter (still image) >

└ AF On >

└ Eye AF >

└ Set. Face Prty in AF >

└ AF in Focus Mag. (still image) >

└ Center Lock-on AF >

└ Focus Hold >

└ Registering the current focus area (AF Area Regist.) (still image) >

└ Deleting a registered AF Area (Del. Reg. AF Area) >

└ Pre-AF (still image) >

- Eye-Start AF (still image) >

---

- AF Track Sens (still image) >

---

- Priority Set in AF-S >

---

- Priority Set in AF-C >

---

- AF Illuminator (still image) >

---

- AF Area Auto Clear >

---

- Disp. cont. AF area >

---

- AF Micro Adj. >

---

- AF System (still image) >

### Manual focus

- Manual Focus >

---

- Direct manual focus (DMF) >

---

- Focus Magnifier >

---

- MF Assist (still image) >

---

- Focus Magnif. Time >

---

- Initial Focus Mag. (still image) >

---

- Peaking Setting >

### Selecting a drive mode (Continuous shooting/Self-timer)

- Drive Mode >

---

- Cont. Shooting >

---

- Displaying continuous shooting remaining time indicator (Cont. Shoot. Length) >

---

- Self-timer >

---

- Self-timer(Cont) >

---

- Cont. Bracket >

---

- Single Bracket >

---

- Indicator during bracket shooting >

---

- WB bracket >

---

- DRO Bracket >

---

- Bracket Settings >

### Using touch functions

- Touch Operation >

---

- Touch Panel/Pad >

---

- Touch Focus >

---

- Touch Pad Settings >

### Selecting still image size/image quality

- JPEG Image Size (still image) >

---

- JPEG Quality (still image) >

---

- Aspect Ratio (still image) >

---

- File Format (still image) >

---

- RAW File Type (still image) >

---

- APS-C/Super 35mm >

---

- Angle of view >

### Selecting a shooting mode

- List of mode dial function >

---

- Intelligent Auto >

---

- About Scene Recognition >

---

- Program Auto >

---

- Aperture Priority >

---

- Shutter Priority >

---

- Manual Exposure >

---

- Bulb shooting >

---

- Scene Selection >

---

- Recall (Camera Settings1/Camera Settings2) >

---

- Movie: Exposure Mode >

---

- S&Q Motion: Exposure Mode >

### Controlling the exposure/metering modes

- Exposure Comp. >

---

- Reset EV Comp. >

---

- Dial Ev Comp >

---

- Exposure Set. Guide >

- Exposure step >

---

- Metering Mode >

---

- Face Prty in Mlti Mtr >

---

- Spot Metering Point >

---

- AE lock >

---

- AEL w/ shutter (still image) >

---

- Exposure Std. Adjust >

---

- Exp.comp.set >

---

- Zebra Setting >

### Correcting brightness and contrast automatically

- D-Range Opt. (DRO) >

---

- Auto HDR >

### Selecting the ISO sensitivity

- ISO >

---

- ISO AUTO Min. SS >

### Using the zoom

- The zoom features available with this product >

---

- Clear Image Zoom/Digital Zoom (Zoom) >

---

- Zoom Setting >

---

- About zoom scale >

---

- Zoom Ring Rotate >

### White balance

- White Balance >

---

- Priority Set in AWB >

---

- Capturing a basic white color in [Custom Setup] mode >

### Setting how to process images

- Creative Style >

---

- Picture Effect >

---

- Color Space (still image) >

### Shutter settings

- Anti-flicker Shoot. (still image) >
- Release w/o Lens >
- Release w/o Card >
- Silent Shooting (still image) >
- e-Front Curtain Shut. >

### Reducing blur

- SteadyShot >
- SteadyShot Settings >

### Lens compensation

- Lens Comp. >

### Noise reduction

- Long Exposure NR (still image) >
- High ISO NR (still image) >

### Face detection

- Regist. Faces Priority >
- Face Registration (New Registration) >
- Face Registration (Order Exchanging) >
- Face Registration (Delete) >

### Using the flash

- Using flash (sold separately) >
- Red Eye Reduction >
- Flash Mode >
- Flash Comp. >
- FEL lock >
- Wireless Flash >

### Recording movies

#### Shooting movies

#### Movie w/ shutter

#### Movie recording formats

#### File Format (movie)

Record Setting (movie)

S&Q Settings

Proxy Recording

Audio Recording

Audio Level Display

Audio Rec Level

Audio Out Timing

Wind Noise Reduct.

Picture Profile

Gamma Disp. Assist

Auto Slow Shut. (movie)

AF drive speed (movie)

AF Track Sens (movie)

TC/UB Settings

TC/UB Disp. Switch

MOVIE Button

Marker Display (movie)

Marker Settings (movie)

4K Output Sel. (movie)

Video Light Mode

## Viewing

### Viewing images

- Playing back still images >
- Enlarging an image being played back (Enlarge Image) >
- Rotating recorded images automatically (Display Rotation) >
- Rotating an image (Rotate) >
- Enlarge Init. Mag. >
- Enlarge Initial Pos. >
- Playing back movies >
- Volume Settings >



- Photo Capture >

---

- Playing back images on the image index screen (Image Index) >

---

- Setting the method for jumping between images (Image Jump Setting) >

---

- Switching between still images and movies (View Mode) >

---

- Disp Cont Shoot Grp >

---

- Selecting which memory card to play back (Select PB Media) >

---

- Copying images from one memory card to another (Copy) >

---

- Playing back images using slideshow (Slide Show) >

### Protecting data

- Protecting images (Protect) >

### Setting Rating function

- Rating >

---

- Rating Set(Cust Key) >

### Designating images for printing (DPOF)

- Specifying images to be printed (Specify Printing) >

### Deleting images

- Deleting a displayed image >

---

- Deleting multiple selected images (Delete) >

---

- Delete confirm. >

### Viewing images on a TV

- Viewing images on a TV using an HDMI cable >

## Customizing the camera

### Registering frequently used functions

- Memory (Camera Settings1/Camera Settings2) >

---

- Select Media (Memory recall) >

---

- Registering shooting settings to a custom key (Reg Cust Shoot Set) >

### Assigning selected functions to the button

- Custom Key (still image/movie/playback) >

---

- Function Menu Set. >

### Customizing the functions of the ring/dial

- Dial Setup >
- Av/Tv Rotate >
- Lock Operation Parts >

### Customizing MENU (My Menu)

- Add Item >
- Sort Item >
- Delete Item >
- Delete Page >
- Delete All >

### Checking images before/after recording

- Auto Review >
- Aperture Preview >
- Shot. Result Preview >
- Live View Display >

### Monitor/viewfinder settings

- Grid Line >
- FINDER/MONITOR >
- Monitor Brightness >
- Viewfinder Bright. >
- Finder Color Temp. >
- Display Quality >
- Bright Monitoring >

### Memory card settings

- Format >
- File Number >
- Set File Name >
- Display Media Info. >
- Rec. Media Settings: Prioritize Rec. Media >
- Rec. Media Settings: Recording Mode >
- Rec. Media Settings: Auto Switch Media >

- Select REC Folder >
- New Folder >
- Folder Name >
- Recover Image DB >

### Camera settings

- Audio signals >
- Pwr Save Start Time >
- Auto Pwr OFF Temp. >
- Remote Ctrl >
- NTSC/PAL Selector >
- HDMI Settings: HDMI Resolution >
- HDMI Settings: 24p/60p Output (movie) (Only for 1080 60i compatible models) >
- HDMI Settings: HDMI Info. Display >
- HDMI Settings: TC Output (movie) >
- HDMI Settings: REC Control (movie) >
- HDMI Settings: CTRL FOR HDMI >
- USB Connection >
- USB LUN Setting >
- USB Power Supply >
- PC Remote Settings: Still Img. Save Dest. >
- PC Remote Settings: RAW+J PC Save Img >
- Language >
- Date/Time Setup >
- Area Setting >
- Copyright Info >
- Version >
- Demo Mode >

### Initializing the camera

- Setting Reset >

### Using network functions

## Connecting this product and a Smartphone

- PlayMemories Mobile >
- Controlling the camera using an Android smartphone (NFC One-touch remote) >
- Controlling the camera using an Android smartphone (QR code) >
- Controlling the camera using an Android smartphone (SSID) >
- Controlling the camera using an iPhone or iPad (QR code) >
- Controlling the camera using an iPhone or iPad (SSID) >

## Transferring images to a Smartphone

- Snd to Smrtphn Func: Send to Smartphone >
- Snd to Smrtphn Func: Sending Target (proxy movies) >
- Sending images to an Android smartphone (NFC One-touch Sharing) >

## Transferring images to a computer

- Send to Computer >
- FTP Transfer Func. >

## Transferring images to a TV

- View on TV >

## Reading location information from a smartphone

- Loc. Info. Link Set. >

## Changing the network settings

- Airplane Mode >
- Wi-Fi Settings: WPS Push >
- Wi-Fi Settings: Access Point Set. >
- Wi-Fi Settings: Disp MAC Address >
- Wi-Fi Settings: SSID/PW Reset >
- Edit Device Name >
- Importing root certification to the camera (Imp Root Certificate) >
- Reset Network Set. >

## Using a computer

Recommended computer environment

Software for Mac computers

## Importing images for use on a computer

- PlayMemories Home >
- Installing PlayMemories Home >
- Connecting to a computer >
- Importing images to the computer without using PlayMemories Home >
- Disconnecting the camera from the computer >

## Developing RAW images/Remote shooting (Imaging Edge)

- Imaging Edge >

## Creating a movie disc

- Selecting a disc to be created >
- Creating Blu-ray Discs from high-definition image quality movies >
- Creating DVD discs (AVCHD recording discs) from high-definition image quality movies >
- Creating DVD discs from standard image quality movies >

## List of MENU items

### Using MENU items

#### Camera Settings1

- File Format (still image) >
- RAW File Type (still image) >
- JPEG Quality (still image) >
- JPEG Image Size (still image) >
- Aspect Ratio (still image) >
- APS-C/Super 35mm >
- Long Exposure NR (still image) >
- High ISO NR (still image) >
- Color Space (still image) >
- Lens Comp. >
- Scene Selection >
- Drive Mode >
- Bracket Settings >
- Recall (Camera Settings1/Camera Settings2) >

- Memory (Camera Settings1/Camera Settings2)	>
- Select Media (Memory recall)	>
- Registering shooting settings to a custom key (Reg Cust Shoot Set)	>
- Focus Mode	>
- Priority Set in AF-S	>
- Priority Set in AF-C	>
- Focus Area	>
- Focus Settings	>
- Adjusting the focus area settings to the camera's orientation (horizontal/vertical) (Sw. V/H AF Area)	>
- AF Illuminator (still image)	>
- Center Lock-on AF	>
- Set. Face Prty in AF	>
- AF Track Sens (still image)	>
- AF System (still image)	>
- AF w/ shutter (still image)	>
- Pre-AF (still image)	>
- Eye-Start AF (still image)	>
- Registering the current focus area (AF Area Regist.) (still image)	>
- Deleting a registered AF Area (Del. Reg. AF Area)	>
- AF Area Auto Clear	>
- Disp. cont. AF area	>
- AF Micro Adj.	>
- Exposure Comp.	>
- Reset EV Comp.	>
- ISO	>
- ISO AUTO Min. SS	>
- Metering Mode	>
- Face Prty in Mlti Mtr	>
- Spot Metering Point	>
- Exposure step	>

- AEL w/ shutter (still image)	>
- Exposure Std. Adjust	>
- Flash Mode	>
- Flash Comp.	>
- Exp.comp.set	>
- Wireless Flash	>
- Red Eye Reduction	>
- White Balance	>
- Priority Set in AWB	>
- D-Range Opt. (DRO)	>
- Auto HDR	>
- Creative Style	>
- Picture Effect	>
- Picture Profile	>
- Focus Magnifier	>
- Focus Magnif. Time	>
- Initial Focus Mag. (still image)	>
- AF in Focus Mag. (still image)	>
- MF Assist (still image)	>
- Peaking Setting	>
- Anti-flicker Shoot. (still image)	>
- Face Registration (New Registration)	>
- Face Registration (Order Exchanging)	>
- Face Registration (Delete)	>
- Regist. Faces Priority	>
<b>Camera Settings2</b>	
- Movie: Exposure Mode	>
- S&Q Motion: Exposure Mode	>
- File Format (movie)	>
- Record Setting (movie)	>

- S&Q Settings	>
- Proxy Recording	>
- AF drive speed (movie)	>
- AF Track Sens (movie)	>
- Auto Slow Shut. (movie)	>
- Audio Recording	>
- Audio Rec Level	>
- Audio Level Display	>
- Audio Out Timing	>
- Wind Noise Reduct.	>
- Marker Display (movie)	>
- Marker Settings (movie)	>
- Video Light Mode	>
- Movie w/ shutter	>
- Silent Shooting (still image)	>
- e-Front Curtain Shut.	>
- Release w/o Lens	>
- Release w/o Card	>
- SteadyShot	>
- SteadyShot Settings	>
- Clear Image Zoom/Digital Zoom (Zoom)	>
- Zoom Setting	>
- Zoom Ring Rotate	>
- DISP Button (Monitor/Finder)	>
- FINDER/MONITOR	>
- Zebra Setting	>
- Grid Line	>
- Exposure Set. Guide	>
- Live View Display	>
- Displaying continuous shooting remaining time indicator (Cont. Shoot. Length)	>



- Auto Review >

---

- Custom Key (still image/movie/playback) >

---

- Function Menu Set. >

---

- Dial Setup >

---

- Av/Tv Rotate >

---

- Dial Ev Comp >

---

- MOVIE Button >

---

- Lock Operation Parts >

---

- Audio signals >

## Network

- Snd to Smrtphn Func: Send to Smartphone >

---

- Snd to Smrtphn Func: Sending Target (proxy movies) >

---

- Send to Computer >

---

- FTP Transfer Func. >

---

- View on TV >

---

- Ctrl w/ Smartphone >

---

- Airplane Mode >

---

- Wi-Fi Settings: WPS Push >

---

- Wi-Fi Settings: Access Point Set. >

---

- Wi-Fi Settings: Disp MAC Address >

---

- Wi-Fi Settings: SSID/PW Reset >

---

- Bluetooth Settings >

---

- Loc. Info. Link Set. >

---

- Edit Device Name >

---

- Importing root certification to the camera (Imp Root Certificate) >

---

- Reset Network Set. >

## Playback

- Protecting images (Protect) >

---

- Rotating an image (Rotate) >

---

- Deleting multiple selected images (Delete) >

- Rating >
- Rating Set(Cust Key) >
- Specifying images to be printed (Specify Printing) >
- Copying images from one memory card to another (Copy) >
- Photo Capture >
- Enlarging an image being played back (Enlarge Image) >
- Enlarge Init. Mag. >
- Enlarge Initial Pos. >
- Playing back images using slideshow (Slide Show) >
- Selecting which memory card to play back (Select PB Media) >
- Switching between still images and movies (View Mode) >
- Playing back images on the image index screen (Image Index) >
- Disp Cont Shoot Grp >
- Rotating recorded images automatically (Display Rotation) >
- Setting the method for jumping between images (Image Jump Setting) >

## Setup

- Monitor Brightness >
- Viewfinder Bright. >
- Finder Color Temp. >
- Gamma Disp. Assist >
- Volume Settings >
- Delete confirm. >
- Display Quality >
- Pwr Save Start Time >
- Auto Pwr OFF Temp. >
- NTSC/PAL Selector >
- Cleaning Mode >
- Touch Operation >
- Touch Panel/Pad >
- Touch Pad Settings >

- Demo Mode	>
- TC/UB Settings	>
- Remote Ctrl	>
- HDMI Settings: HDMI Resolution	>
- HDMI Settings: 24p/60p Output (movie) (Only for 1080 60i compatible models)	>
- HDMI Settings: HDMI Info. Display	>
- HDMI Settings: TC Output (movie)	>
- HDMI Settings: REC Control (movie)	>
- HDMI Settings: CTRL FOR HDMI	>
- 4K Output Sel. (movie)	>
- USB Connection	>
- USB LUN Setting	>
- USB Power Supply	>
- PC Remote Settings: Still Img. Save Dest.	>
- PC Remote Settings: RAW+J PC Save Img	>
- Language	>
- Date/Time Setup	>
- Area Setting	>
- Copyright Info	>
- Format	>
- File Number	>
- Set File Name	>
- Rec. Media Settings: Prioritize Rec. Media	>
- Rec. Media Settings: Recording Mode	>
- Rec. Media Settings: Auto Switch Media	>
- Select REC Folder	>
- New Folder	>
- Folder Name	>
- Recover Image DB	>
- Display Media Info.	>

Version	>
Setting Reset	>
My Menu	
Add Item	>
Sort Item	>
Delete Item	>
Delete Page	>
Delete All	>

## Precautions/This product

### Precautions

#### On cleaning

#### Cleaning the image sensor

Cleaning Mode	>
---------------	---

#### Number of recordable images

#### Recordable movie times

#### Using the AC Adaptor/battery charger abroad

#### AVCHD format

#### License

#### Specifications

#### Trademarks

#### List of default setting values

## If you have problems

### Troubleshooting

### Warning messages

## Front side

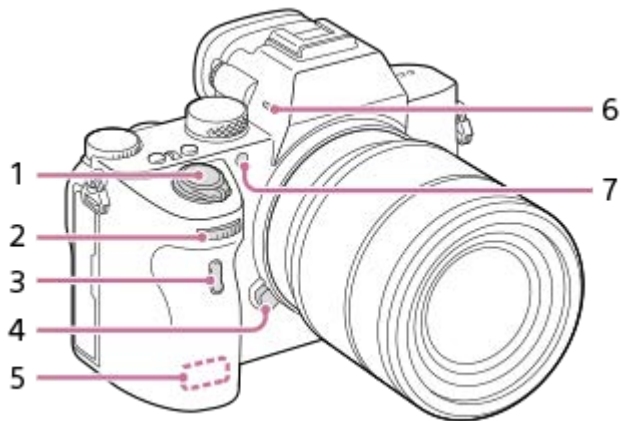

1. ON/OFF (Power) switch/Shutter button
2. Front dial  
You can quickly adjust the settings for each shooting mode.
3. Remote sensor
4. Lens release button
5. Wi-Fi/Bluetooth antenna (built-in)
6. Microphone  
Do not cover this part during movie recording. Doing so may cause noise or lower the volume.
7. AF illuminator/Self-timer lamp

### When the lens is removed

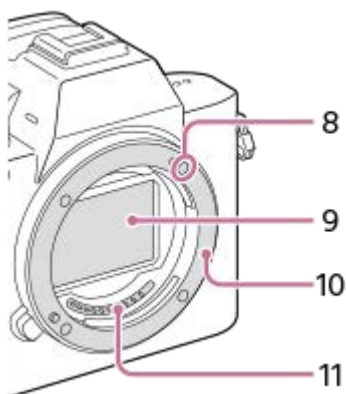

8. Mounting index
9. Image sensor\*
10. Mount
11. Lens contacts\*

\* Do not directly touch these parts.

## Rear side

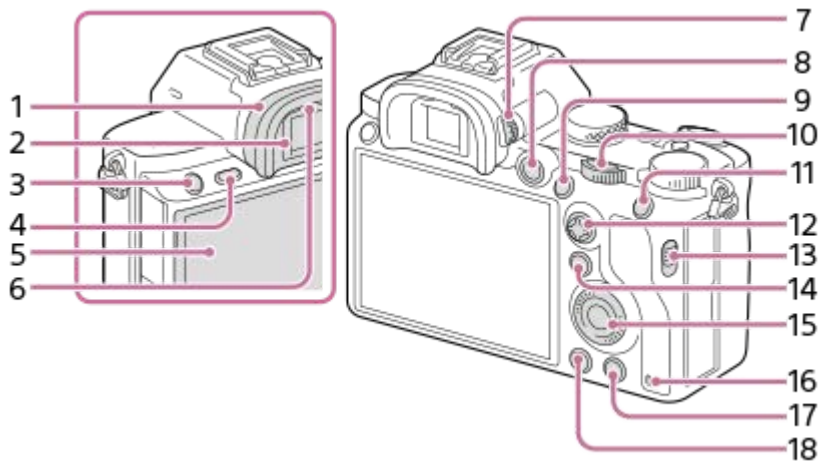

### 1. Eyepiece Cup

#### To remove the eyepiece cup

Push the grips at the bottom of the eyepiece cup to the left and right and lift up the cup.

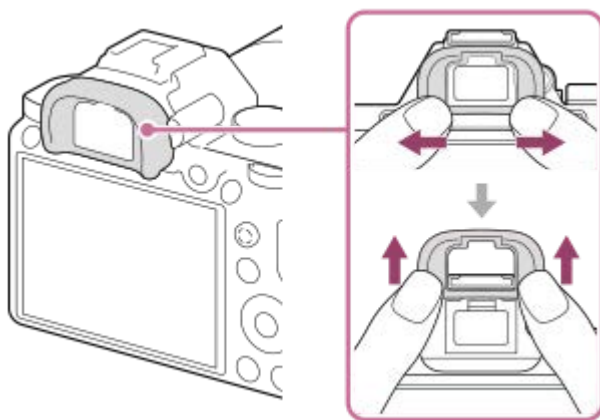

Remove the eyepiece cup when attaching an angle viewfinder (sold separately). Also, select MENU →  2 (Camera Settings2) → [FINDER/MONITOR], and then switch to [Viewfinder(Manual)] or [Monitor(Manual)].

### 2. Viewfinder

3. C3 button (Custom button 3) /  (Protect) button

4. MENU button

5. Monitor (For touch operation: Touch panel/Touch pad)

You can adjust the monitor to an easily viewable angle and shoot from any position.



**6. Eye sensor**

**7. Diopter-adjustment dial**

Adjust the diopter-adjustment dial according to your eyesight until the display appears clearly in the viewfinder. If it is hard to operate the diopter-adjustment dial, remove the eyepiece cup before operating the dial.

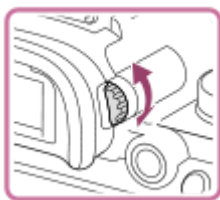

**8. MOVIE (Movie) button**

**9. For shooting: AF-ON (AF On) button**

For viewing:  (Enlarge) button

**10. Rear dial**

You can quickly adjust the settings for each shooting mode.

**11. For shooting: AEL button**

For viewing:  (Image index) button

**12. Multi-selector**

**13. Media slot cover switch**

**14. For shooting: Fn (Function) button**

For viewing:  (Send to Smartphone) button

You can display the screen for [Send to Smartphone] by pressing this button.

**15. Control wheel**

**16. Access lamp**

**17. For shooting: C4 button (Custom button 4)**

For viewing:  (Delete) button

**18.  (Playback) button**

**Top side/Side view**

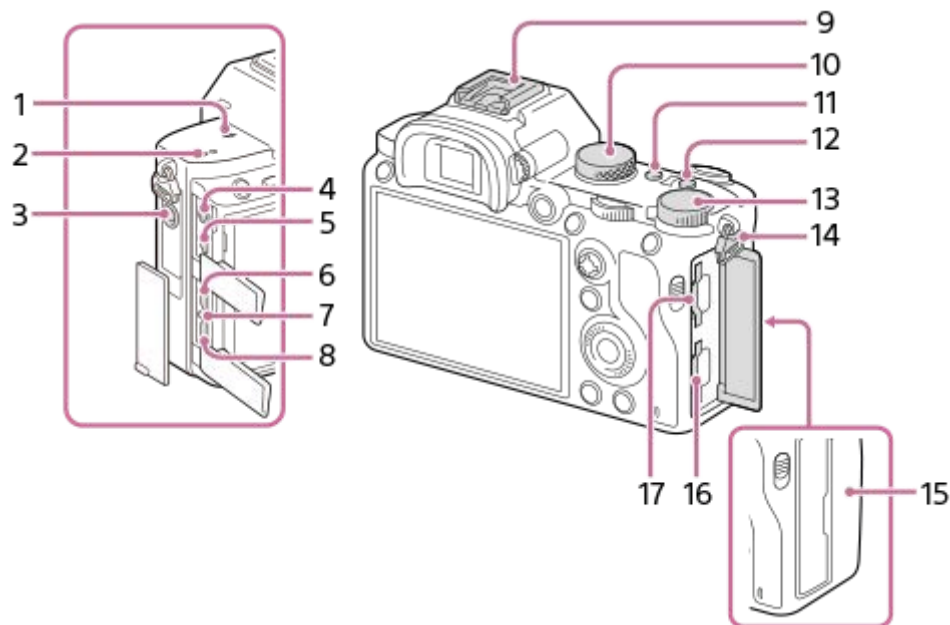

1.  Image sensor position mark

- The image sensor is the sensor that converts light into an electric signal. The  mark shows the location of the image sensor. When you measure the exact distance between the camera and the subject, refer to the position of the horizontal line.

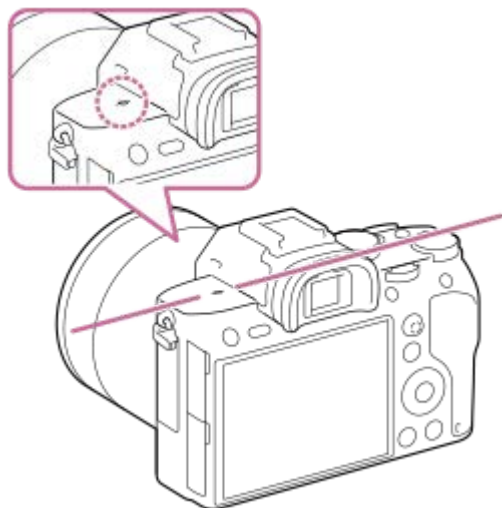

- If the subject is closer than the minimum shooting distance of the lens, the focus cannot be confirmed. Make sure you put enough distance between the subject and the camera.

2. Speaker

3.  (Microphone) jack

When an external microphone is connected, the built-in microphone turns off automatically. When the external microphone is a plugin-power type, the power of the microphone is supplied by the camera.

4.  (Headphones) jack

5. HDMI micro jack

6. USB Type-C terminal



7. Charge lamp

8. Multi/Micro USB Terminal\*

This terminal supports Micro USB-compatible devices.

9. Multi Interface Shoe\*

Some accessories may not go in all the way and protrude backward from the Multi interface shoe. However, when the accessory reaches the front end of the shoe, the connection is completed.

10. Mode dial

11. C2 button (Custom button 2)

12. C1 button (Custom button 1)

13. Exposure compensation dial

14. Hooks for shoulder strap

Attach both ends of the strap onto the camera.

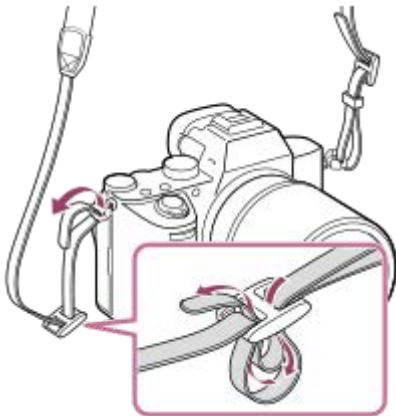

15.  (N mark)

- This mark indicates the touch point for connecting the camera and an NFC-enabled Smartphone.

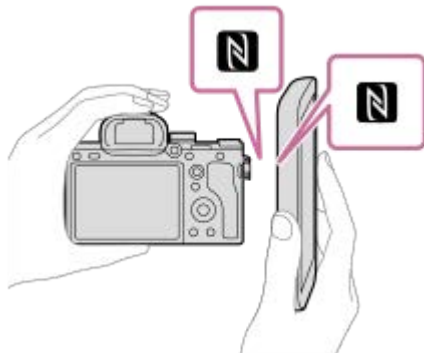

- NFC (Near Field Communication) is an international standard of short-range wireless communication technology.

16. SLOT 1 (Memory card slot 1)

Supports SD cards only (compatible with UHS-I and UHS-II)

17. SLOT 2 (Memory card slot 2)

Supports SD cards (compatible with UHS-I) and Memory Stick PRO Duo media

\* For details on compatible accessories for the multi interface shoe and the Multi/Micro USB Terminal, visit the Sony website, or consult your Sony dealer or local authorized Sony service facility. Accessories for the Accessory Shoe can also be used. Operations with other manufactures' accessories are not guaranteed.



## Notes on USB terminals

You can use either the USB Type-C terminal or the Multi/Micro USB Terminal for supplying power, charging the battery, and USB communications. However, you cannot conduct these operations with both terminals simultaneously.

- The battery charging time does not change according to the terminal you use.
- You can use accessories for the Multi/Micro USB Terminal, such as a remote commander (sold separately), while supplying power or performing PC Remote shooting using the USB Type-C terminal.

Interchangeable Lens Digital Camera  
ILCE-7M3 α7III

## Bottom

---

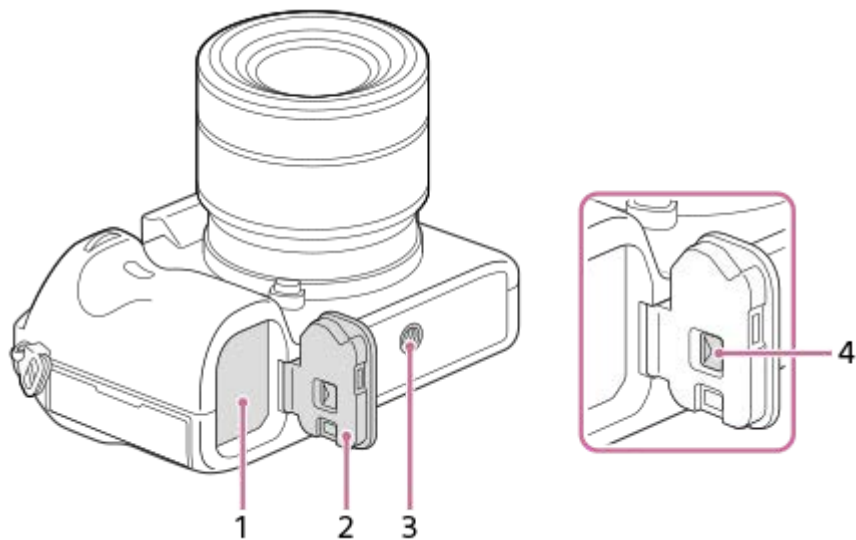

1. Battery insertion slot
2. Battery cover
3. Tripod socket hole

Use a tripod with a screw less than 5.5 mm (7/32 inches) long. Otherwise, you cannot firmly secure the camera, and damage to the camera may occur.

4. Battery cover release lever

Interchangeable Lens Digital Camera  
ILCE-7M3 α7III

## Lens FE 28-70 mm F3.5-5.6 OSS (Supplied with ILCE-7M3K)

---

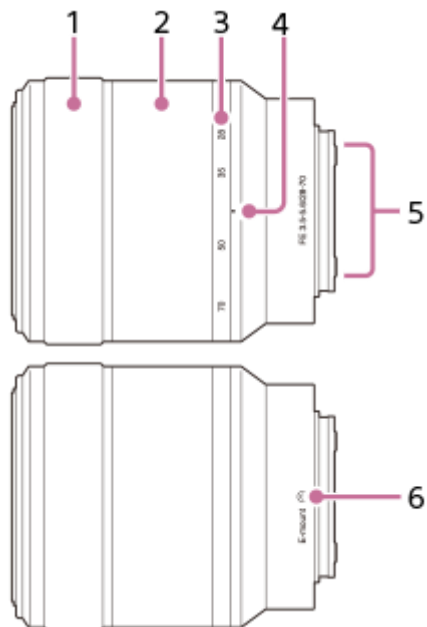



1. Focusing ring
2. Zoom ring
3. Focal-length scale
4. Focal-length index
5. Lens contacts  
Do not touch this part directly.
6. Mount index

Interchangeable Lens Digital Camera  
ILCE-7M3 α7III

## Using the control wheel

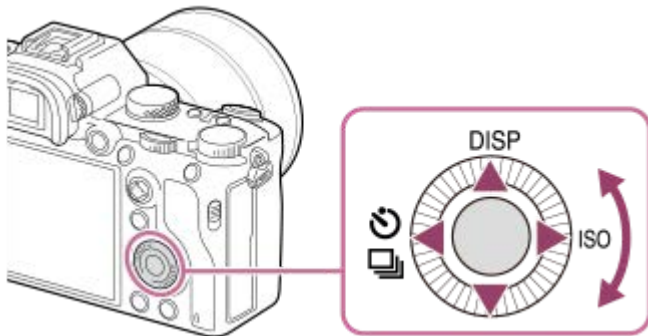
---



- You can select setting items by turning or pressing the top/bottom/left/right side of the control wheel. Your selection is determined when you press the center of the control wheel.
- The DISP (Display Setting),  /  (Drive Mode), and ISO (ISO) functions are assigned to the top/left/right side of the control wheel. In addition, you can assign selected functions to the left/right/bottom side and the center of the control wheel, and to the rotation of the control wheel.
- During playback, you can display the next/previous image by pressing the right/left side of the control wheel or by turning the control wheel.

---

### Related Topic

- [Focus Standard](#)
- [Custom Key \(still image/movie/playback\)](#)

Interchangeable Lens Digital Camera  
ILCE-7M3 α7III

## Using the multi-selector

---

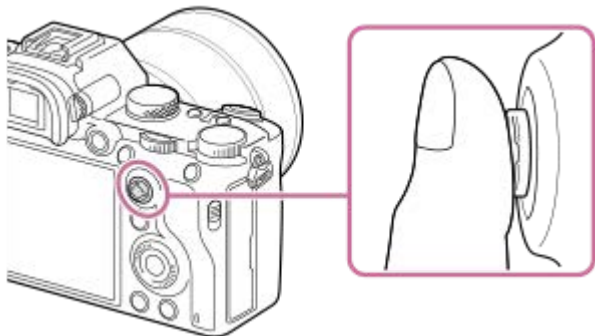

- Put your finger right on top of the multi-selector to manipulate it more precisely.
  - When [Focus Area] is set to [Zone], [Flexible Spot], or [Expand Flexible Spot], you can move the focus area by pressing the multi-selector up/down/left/right.
  - The [Focus Standard] function is assigned to the center of the multi-selector in the default settings.
- 

### Related Topic

- [Focus Area](#)
- [Focus Standard](#)

## Using MENU items

You can change settings related to all the camera operations including shooting, playback, and operating method. You can also execute camera functions from the MENU.

- 1 Press the MENU button to display the menu screen.

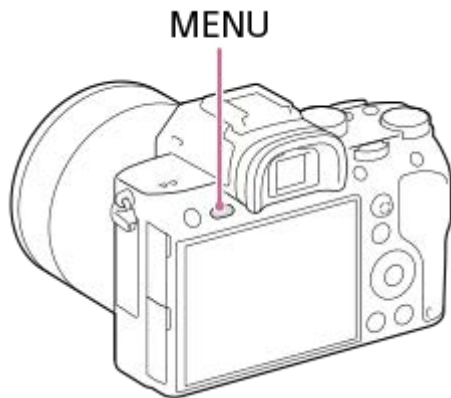

- 2 Select the desired setting you want to adjust using the top/bottom/left/right sides of the control wheel or by turning the control wheel, and then press the center of the control wheel.

- Select an icon at the top of the screen (A) and press the left/right side of the control wheel to move to another MENU item.
- You can go back to the previous screen by pressing the MENU button (B).

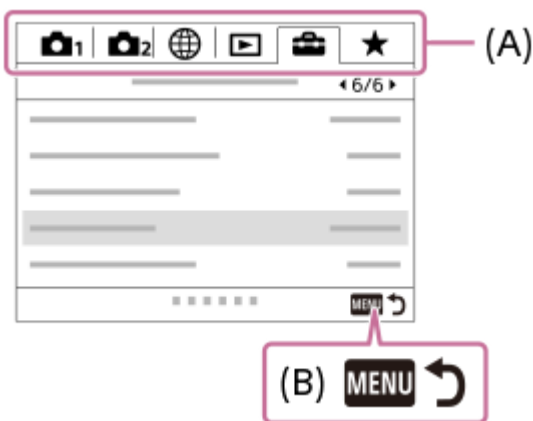

- 3 Select the desired setting value, and press the center to confirm your selection.

### Related Topic

- [Add Item](#)

## Using the Fn (Function) button

You can register frequently used functions to the Fn (Function) button and recall them while shooting. Up to 12 frequently used functions can be registered to the Fn (Function) button.

- 1 Press the DISP on the control wheel repeatedly to display a screen mode other than [For viewfinder], and then press the Fn (Function) button.

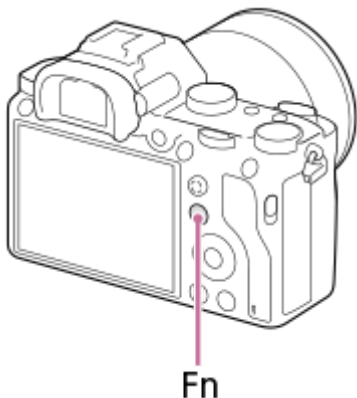

- 2 Select the desired function by pressing the top/bottom/left/right side of the control wheel.

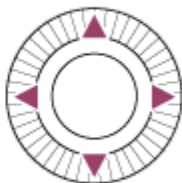
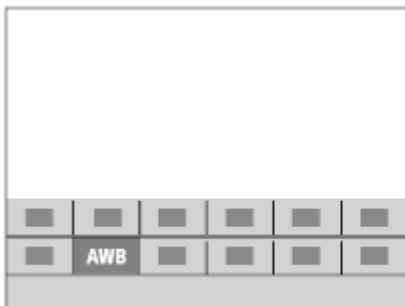

- 3 Select the desired setting by turning the front dial, and press the center of the control wheel.

- Some functions can be fine-tuned using the rear dial.

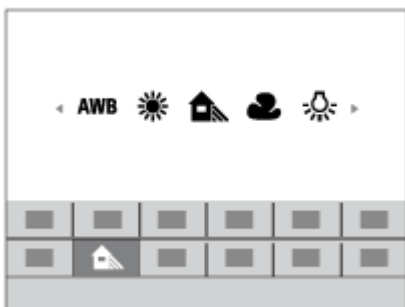

To adjust settings from the dedicated setting screens



Select the desired function in step 2, then press the center of the control wheel. The dedicated setting screen for the function will appear. Follow the operating guide **(A)** to adjust settings.

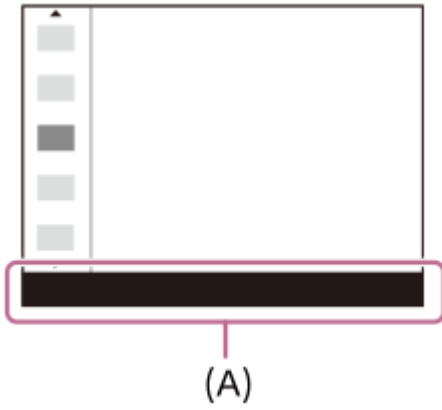



---

### Related Topic

- [Function Menu Set.](#)

## How to use the Quick Navi screen

The Quick Navi screen is a function optimized for shooting with the viewfinder, that lets you control settings directly.

- 1 MENU →  2 (Camera Settings2) → [DISP Button] → [Monitor].
- 2 Place a  mark on [For viewfinder] and then select [Enter].
- 3 Press the DISP on the control wheel to set the screen mode to [For viewfinder].
- 4 Press the Fn button to switch to the Quick Navi screen.
  - The displayed contents and their positions in the illustrations are just guidelines, and may differ from the actual displays.

### Auto mode/Scene Selection mode



### P/A/S/M mode



- 5 Select the desired function by pressing the top/bottom/left/right side of the control wheel.
- 6 Select the desired setting by turning the front dial.
  - Some functions can be fine-tuned using the rear dial.

### To adjust settings from the dedicated setting screens

Select the desired function in step 5, then press the center of the control wheel. The dedicated setting screen for the function will appear. Follow the operating guide (A) to adjust settings.

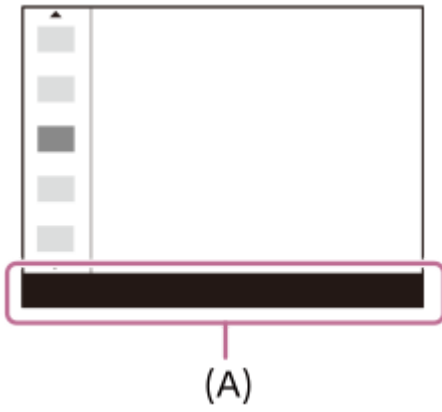

### Note

- Items that are gray on the Quick Navi screen are not adjustable.
- When using [Creative Style], [Picture Profile], etc., some of the setup tasks can only be accomplished on a dedicated screen.

---

### Related Topic

- [Switching the screen display \(while shooting/during playback\)](#)

Interchangeable Lens Digital Camera  
ILCE-7M3 α7III

## How to use the keyboard

When manual character entry is required, a keyboard is displayed on the screen.



Move the cursor on desired key using the control wheel, then press the center to enter.

### 1. Input box

The characters you entered are displayed.

### 2. Switch character types

Each time you press this key, the character type will switch between alphabet letters, numerals and symbols.

### 3. Keyboard

Each time you press this key, the characters corresponding to that key will be displayed one-by-one in order.

#### For example: If you want to enter "abd"

Press the key for "abc" once to display "a" → select " →" (5) and press the key for "abc" twice to display "b" → press the key for "def" once to display "d."

### 4. Finalize

Finalizes the entered characters.

### 5. Move cursor

Moves the cursor in the input box to the right or left.

### 6. Delete

Deletes the character preceding the cursor.

### 7. ↑

Switches the next character to a capital or lowercase letter.

### 8. ␣

Enters a space.

- To cancel input, select [Cancel].

## List of icons on the monitor

The displayed contents and their positions in the illustrations are just guidelines, and may differ from the actual displays.

### Icons on the shooting screen

#### Monitor mode

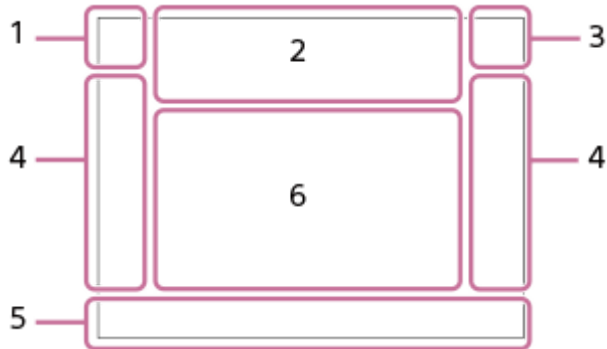

#### Viewfinder mode

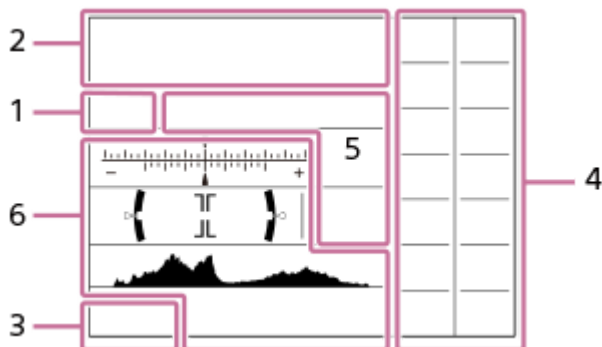

#### 1. Shooting mode/Scene recognition

P P\* A S M   
Shooting mode

**1 2**  
   
Register number

Scene Recognition icons

Scene Selection

#### 2. Camera settings

**NO CARD**  
Memory card status

**100**  
Remaining number of recordable images

**||||| 3**  
Writing data / Number of images left to write

**3:2 16:9**  
Aspect ratio of still images

24M / 20M / 10M / 8.7M / 6.0M / 5.1M / 2.6M / 2.2M

Image size of still images

**RAW** **RAW**

RAW recording (compressed/uncompressed)

**X.FINE FINE STD**

JPEG Quality

**XAVC S 4K XAVC S HD AVCHD**

File format of movies

**100** **60** **50** **25** **16** **FX** **FH**

Record setting of movies

**120p 60p 60i 30p 24p 100p 50p 50i 25p**

Frame rate of movies

**100px** **60px** **50px** **25px** **16px**

Proxy Recording

**120fps 60fps 30fps 15fps 8fps 4fps 100fps 50fps 25fps 12fps 6fps 3fps 2fps 1fps**

Frame rate for slow/quick motion shooting



APS-C/Super 35mm



Flash charge in progress

**VIEW**

Setting Effect OFF



AF Illuminator

**Flicker**

Flickering detected



SteadyShot off/on, Camera shake warning



SteadyS. Focal Len./ Camera shake warning



Smart Zoom/ Clear Image Zoom/Digital Zoom

**-PC-**

PC remote



Bright Monitoring



Silent Shooting



Infrared remote control



No audio recording of movies



Wind Noise Reduct.



Copyright information writing on

Assist 5-Log2 Assist 5-Log3 Assist HLG 709 Assist HLG 2020

Gamma Disp. Assist



Focus Cancel



Lock-on AF Cancel

**Spot Focus**

Performing [Spot Focus]



NFC active



Bluetooth connection available / Bluetooth connection unavailable



Connected to smartphone / Not connected to smartphone



Obtaining location information / Location information cannot be obtained



Airplane Mode



Overheating warning



Database file full / Database file error

### 3. Battery



Remaining battery



Remaining battery warning



USB power supply

### 4. Shooting settings

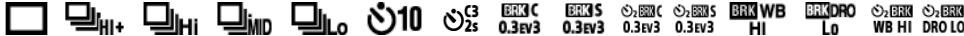

Drive Mode



Flash Mode/Wireless Flash/Red Eye Reduction



Flash Comp. ±0.0



Focus Mode



File Format



Focus Area



Metering Mode



White Balance (Auto, Preset, Underwater Auto, Custom, Color temperature, Color filter)



D-Range Opt. /Auto HDR



Creative Style /Contrast, saturation, and sharpness



Picture Effect

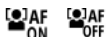

Face Priority in AF



Picture Profile



Prioritize Rec. Media

### 5. Focus indicator/exposure settings



Focus indicator

1/250

Shutter speed

### F3.5

Aperture value



Exposure compensation/Metered Manual

**ISO400**

**ISO AUTO**

ISO sensitivity



AE lock/FEL lock

### 6. Guides/other

● **Lock-on AF**

● **Lock-on AF Cancel**

Guide display for Lock-on AF

● **Focus Cancel**

Guide display for canceling focusing

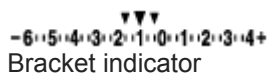

Bracket indicator



Spot metering area



Exposure Setting Guide



Shutter speed indicator



Aperture indicator



Histogram

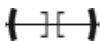

Digital level gauge

**STBY REC**

Movie recording standby/Movie recording in progress

**1:00:12**

Actual movie recording time (hours: minutes: seconds)



Audio Level Display



REC Control

**00:00:00:00**

Time code (hours: minutes: seconds: frames)

**00 00 00 00**

User Bit

## Icons on the playback screen

### Single-image playback



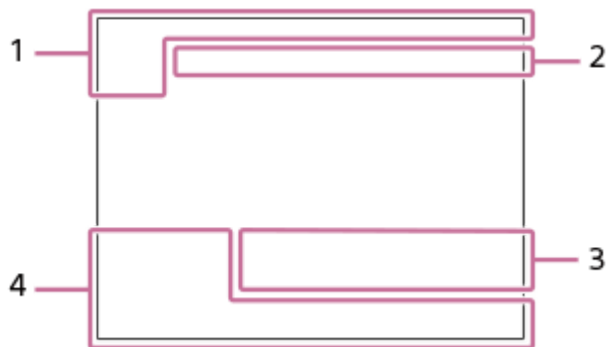

**Histogram display**

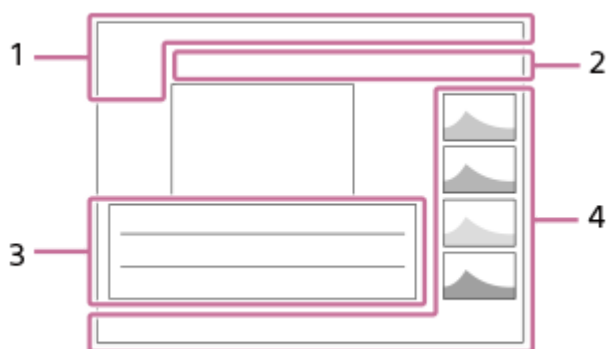

**1. Basic information**



Playback media



View Mode



Rating



Protect

**DPOF**

DPOF set

**3/7**

File number/Number of images in the view mode



NFC active



Remaining battery



Continuous shooting group



Proxy movie included

**2. Camera settings**

Refer to “Icons on the shooting screen.”

**3. Shooting settings**



Picture Effect error



Auto HDR error

**35mm**

Lens focal length

**HLG**

HDR recording (Hybrid Log-Gamma)

Refer to "Icons on the shooting screen" for other icons displayed in this area.

#### 4. Image information

 **90°44'55"N**  
**233°44'55"W**

Latitude/longitude information

**2018-1-1 10:37AM**

Date of recording

 **100-0003**

Folder number - file number



Histogram (Luminance/R/G/B)

## Switching the screen display (while shooting/during playback)

You can change the display contents on the screen.

### 1 Press the DISP (Display Setting) button.

- To switch the information displayed on the viewfinder, press the DISP button while looking into the viewfinder.
- Each time you press the DISP button, the screen display changes.
- The displayed contents and their position are just a guideline, and may differ from the actual display.

#### During shooting (Monitor)

Display All Info. → No Disp. Info. → Histogram → Level → For viewfinder → Display All Info.

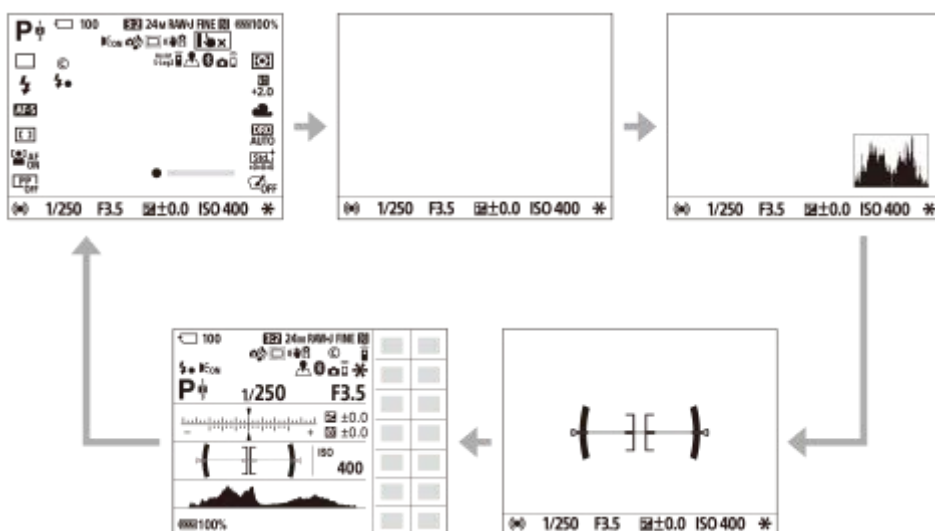

#### During shooting (Viewfinder)

Level → No Disp. Info. → Histogram → Level



#### During playback (Monitor/Viewfinder)

Display Info. → Histogram → No Disp. Info. → Display Info.

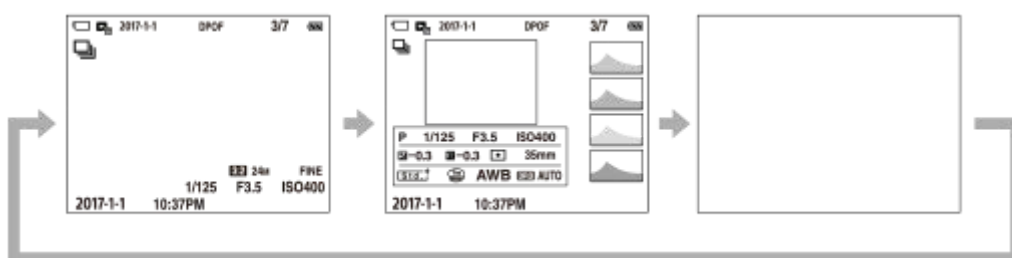

- If the image has an overexposed or underexposed area, the corresponding section will blink on the histogram display (overexposed/underexposed warning).
- The settings for playback are also applied in [Auto Review].

## Histogram display

A histogram shows the luminance distribution, displaying how many pixels there are by luminance. It shows darker toward the left and brighter toward the right.

The histogram changes depending on the exposure compensation.

A peak at the right or left end of the histogram indicates that the image has an overexposed or underexposed area, respectively. You cannot correct such defects using a computer after shooting. Perform exposure compensation before shooting as necessary.



(A): Pixel count  
(B): Brightness

### Note

- The viewfinder display and the monitor display for shooting can be set separately. Look through the viewfinder to set the display settings for the viewfinder.
- The information in the histogram display does not indicate the final photograph. It is information about image displayed on the screen. The final result depends on the aperture value, etc.
- The histogram display is extremely different between shooting and playback in the following cases:
  - When the flash is used
  - When shooting a low luminance subject such as a night scene
- In movie mode, [For viewfinder] cannot be displayed.

### Hint

- The following are not displayed in the default settings.
  - Graphic Display
  - Monitor Off
  - Display All Info. (when using the viewfinder)

To change the display modes that are switched when you press the DISP button, select MENU → 2 (Camera Settings2) → [DISP Button] and change the setting.

## Related Topic

- DISP Button (Monitor/Finder)

4-732-947-11(1) Copyright 2018 Sony Corporation

## DISP Button (Monitor/Finder)

Allows you to set the screen display modes that can be selected using DISP (Display Setting) in shooting mode.

1 MENU →  2 (Camera Settings2) → [DISP Button] → [Monitor] or [Finder] → desired setting → [Enter].

The items marked with  are available.

### Menu item details

#### Graphic Display :

Shows basic shooting information. Graphically shows the shutter speed and aperture value.

#### Display All Info. :

Shows recording information.

#### No Disp. Info. :

Does not show recording information.

#### Histogram :

Displays the luminance distribution graphically.

#### Level :

Indicates whether the product is level in both the front-back **(A)** and horizontal **(B)** directions. When the product is level in either direction, the indicator turns to green.

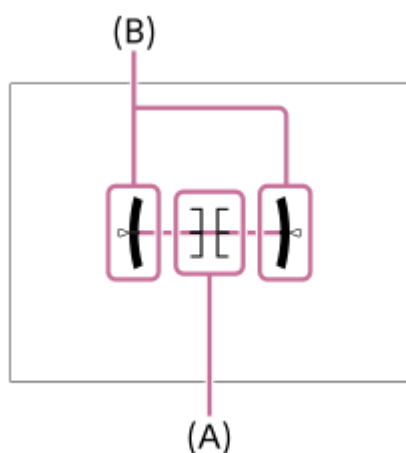

#### For viewfinder\*:

Displays only shooting information on the monitor, not the subject. This setting is a display setting for shooting with the viewfinder.

#### Monitor Off\*:

Always turns the monitor off when shooting images. You can use the monitor when playing back images or operating MENU. This setting is a display setting for shooting with the viewfinder.

\* These screen modes are available only in the setting for [Monitor].

### Note

- If you tilt the product forward or backward by a large degree, the level error will be great.
- The product may have a margin of error of almost  $\pm 1^\circ$  even when the inclination is corrected by the level.

---

---

## Related Topic

- [Switching the screen display \(while shooting/during playback\)](#)

4-732-947-11(1) Copyright 2018 Sony Corporation

Interchangeable Lens Digital Camera  
 ILCE-7M3 α7III

## Checking the camera and the supplied items

First check the model name of your camera. The accessories supplied differ depending on the model. The number in parentheses indicates the number of pieces.

### Supplied with all models

- Camera (1)
- AC Adaptor (1)  
 The shape of the AC Adaptor may differ depending on the country/region.
- Power cord (mains lead) (1)\* (supplied in some countries/regions)

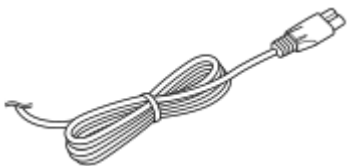

\* Multiple power cords may be supplied with your camera. Use the appropriate one that matches your country/region.

- Rechargeable Battery Pack NP-FZ100 (1)



- Micro USB cable (1)

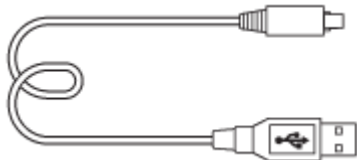

- Shoulder Strap (1)

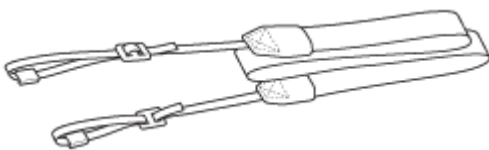

- Body Cap (1) (Attached to the camera)



- Shoe Cap (1) (Attached to the camera)
- Eyepiece Cup (1) (Attached to the camera)
- Instruction Manual (1)
- Reference Guide (1)

### ILCE-7M3K

- FE 28-70 mm F3.5-5.6 OSS zoom lens (1) (including front lens cap and rear lens cap)
- Lens Hood (1)





## Inserting/removing the battery pack

- 1 Open the battery cover.

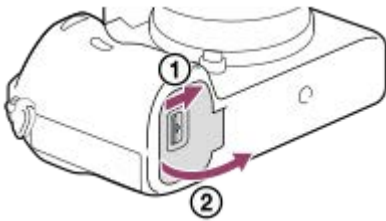

- 2 Insert the battery pack while pressing the lock lever (A) with the tip of the battery until the battery locks into place.

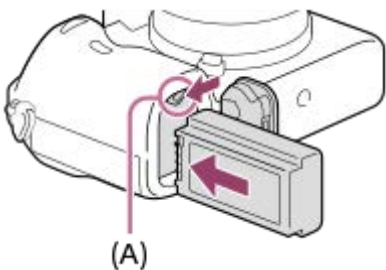

- 3 Close the cover.



### To remove the battery pack

Make sure that the access lamp is not lit, and turn off the camera. Then, slide the lock lever (A) and remove the battery pack. Be careful not to drop the battery pack.

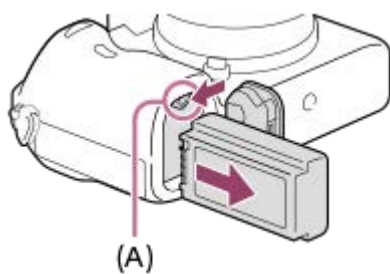

Interchangeable Lens Digital Camera  
ILCE-7M3 α7III

## Charging the battery pack while it is inserted in the camera

- 1 Turn the power off.
- 2 Connect the camera with the battery pack inserted to the AC Adaptor (supplied) using the USB cable, and connect the AC Adaptor to the wall outlet (wall socket).

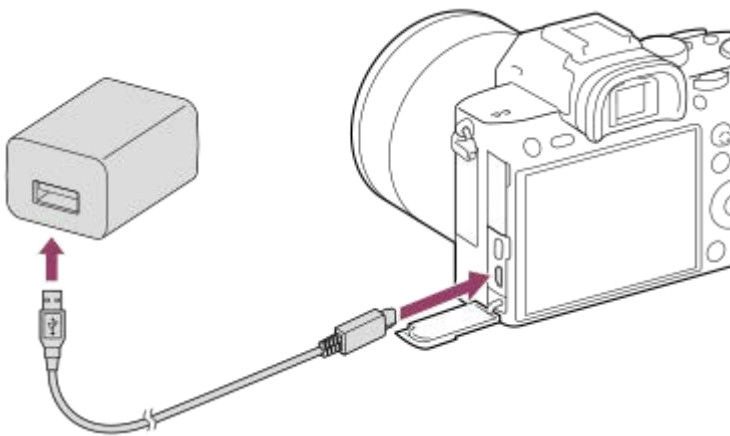

### Charge lamp on the camera (orange)

Lit: Charging

Off: Charging finished

Flashing: Charging error or charging paused temporarily because the camera is not within the proper temperature range

- Charging time (Full charge): The charging time is approximately 285 min.
- The above charging time applies when charging a fully depleted battery pack at a temperature of 25 °C (77 °F). Charging may take longer depending on conditions of use and circumstances.
- The charge lamp turns off when charging is completed.
- If the charge lamp lights up and then immediately turns off, the battery pack is fully charged.

### Note

- If the charge lamp flashes when the battery pack is not fully charged, remove the battery pack or disconnect the USB cable from the camera and then re-insert it to recharge.
- If the charge lamp on the camera flashes when the AC Adaptor is connected to the wall outlet (wall socket), this indicates that charging is temporarily stopped because the temperature is outside the recommended range. When the temperature gets back within the appropriate range, the charging resumes. We recommend charging the battery pack at an ambient temperature of between 10°C to 30°C (50°F to 86°F).
- Use a nearby wall outlet (wall socket) when using the AC Adaptor/Battery Charger. If any malfunction occurs, disconnect the plug from the wall outlet (wall socket) immediately to disconnect from the power source.  
If you use the product with a charge lamp, note that the product is not disconnected from the power source even when the lamp turns off.
- If you turn on the camera, power will be supplied from the wall outlet (wall socket) and you will be able to operate the camera. However, the battery pack will not be charged.
- When you use a completely new battery pack or a battery pack that has not been used for a long time, the charge lamp may flash quickly when the battery is charged. If this happens, remove the battery pack or disconnect the USB cable from the camera and then re-insert it to recharge.

- Do not continuously or repeatedly charge the battery pack without using it if it is already fully charged or close to fully charged. Doing so may cause a deterioration in battery performance.
- When charging is finished, disconnect the AC Adaptor from the wall outlet (wall socket).
- Be sure to use only genuine Sony brand battery packs and AC Adaptors.
- Use the USB cable (supplied) or a USB-standard cable.
- The charging time is the same even when using the USB Type-C cable.

---

### Related Topic

- [Notes on the battery pack](#)
- [Notes on charging the battery pack](#)
- [Using the AC Adaptor/battery charger abroad](#)

## Charging by connecting to a computer

The battery pack can be charged by connecting the camera to a computer using a USB cable.

- 1 Turn off the product, and connect to the USB terminal of the computer.

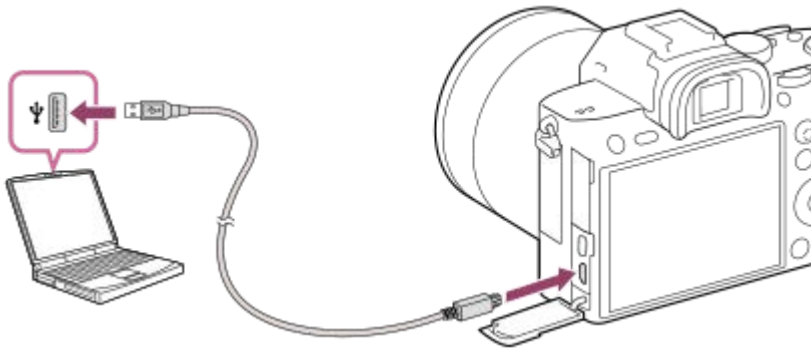

### Note

- If the product is connected to a laptop computer that is not connected to a power source, the laptop battery level decreases. Do not leave the product connected to a laptop computer for an extended period of time.
- Do not turn on/off or restart the computer, or wake the computer from sleep mode when a USB connection has been established between the computer and the camera. Doing so may cause a malfunction. Before turning on/off or restarting the computer, or waking the computer from sleep mode, disconnect the camera from the computer.
- Proper operation cannot be guaranteed on all types of computers.
- Charging cannot be guaranteed with a custom-built computer, modified computer, or a computer connected through a USB hub.
- The camera may not operate correctly when other USB devices are used at the same time.

### Related Topic

- [Notes on the battery pack](#)
- [Notes on charging the battery pack](#)

Interchangeable Lens Digital Camera  
ILCE-7M3 α7III

## Battery life and number of recordable images

		Battery life	Number of images
Shooting (still images)	Screen mode	-	Approx. 710
	Viewfinder mode	-	Approx. 610
Actual shooting (movies)	Screen mode	Approx. 125 min.	-
	Viewfinder mode	Approx. 115 min.	-
Continuous shooting (movies)	Screen mode	Approx. 210 min.	-
	Viewfinder mode	Approx. 200 min.	-

### Note

- The above estimates for battery life and number of recordable images apply when the battery pack has been fully charged. The battery life and number of images may decrease depending on the conditions of use.
- The battery life and number of recordable images are estimates based on shooting with the default settings under the following conditions:
  - Using the battery pack at an ambient temperature of 25°C (77°F).
  - Using a Sony SDXC memory card (U3) (sold separately)
  - Using a FE 28-70mm F3.5-5.6 OSS lens
- The numbers for “Shooting (still images)” are based on the CIPA standard and shooting under the following conditions: (CIPA: Camera & Imaging Products Association)
  - One picture is taken every 30 seconds.
  - The power is turned on and off once every ten times.
- The number of minutes for movie shooting is based on the CIPA standard and shooting under the following conditions:
  - The image quality is set to XAVC S HD 60p 50M /50p 50M.
  - Actual shooting (movies): Battery life based on repeated shooting, zooming, shooting stand-by, turning on/off, etc.
  - Continuous shooting (movies): Battery life based on non-stop shooting until the limit (29 minutes) has been reached, and then continued by pressing the MOVIE (Movie) button again. Other functions, such as zooming, are not operated.

Interchangeable Lens Digital Camera  
ILCE-7M3 α7III

## Supplying power from a wall outlet (wall socket)

Use the supplied AC adaptor to shoot and play back images while power is supplied from a wall outlet (wall socket). This conserves the camera's battery power.

- 1 Insert the battery pack into the camera.
- 2 Connect the camera to the wall outlet (wall socket) with a USB cable and the AC adaptor (supplied).

### Note

- The camera will not activate if there is no remaining battery. Insert a sufficiently charged battery pack into the camera.
- If you use the camera while power is being supplied from a wall outlet (wall socket), make sure that the icon that shows that powering via USB is in progress (  ) is displayed on the monitor.
- Do not remove the battery pack while power is supplied from a wall outlet (wall socket). If you remove the battery pack, the camera will be turned off.
- Do not remove the battery pack while the access lamp is lit. The data in the memory card may be damaged.
- As long as the power is on, the battery pack will not be charged even if the camera is connected to the AC Adaptor.
- Under certain conditions, power may be supplied from the battery pack supplementarily even if you are using the AC adaptor.
- Do not remove the USB cable while power is supplied from a wall outlet (wall socket). Before you remove the USB cable, turn off the camera.
- Depending on the camera and battery temperature, the continuous recording time may be shortened while power is supplied from a wall outlet (wall socket).
- When using a mobile charger as a power source, confirm that it is fully charged before use. Also, be careful of the remaining power on the mobile charger during use.

Interchangeable Lens Digital Camera  
ILCE-7M3 α7III

## Notes on the battery pack

### Notes on using the battery pack

- Be sure to use only battery packs specified for this product.
- The correct remaining battery indicator may not be displayed under some operating or environmental conditions.
- Do not expose the battery pack to water. The battery pack is not water-resistant.
- Do not leave the battery pack in extremely hot places, such as in a car or under direct sunlight.

### Charging the battery pack

- Charge the battery pack (supplied) before using the product for the first time.
- The charged battery pack will discharge little by little even if you do not use it. Charge the battery pack each time before you use the product so that you do not miss any opportunities to shoot images.
- Do not charge battery packs except battery packs specified for this product. Doing so can result in leaks, overheating, explosions, electric shocks, burns, or injuries.
- If the charge lamp flashes when the battery pack is not fully charged, remove the battery pack or disconnect the USB cable from the camera and then reinsert it to recharge.
- We recommend charging the battery pack in an ambient temperature of between 10 °C and 30 °C (50 °F and 86 °F). The battery pack may not be effectively charged in temperatures outside this range.
- When you connect this product and a laptop computer that is not connected to a power source, the laptop's battery charge may decrease. Do not charge this product using the laptop computer for too long.
- Do not turn on/restart a computer, wake a computer from sleep mode, or turn off a computer while this product is connected to the computer via USB cable. Doing so may cause a malfunction of this product. Disconnect the product and the computer before performing the above operations.
- We do not guarantee charging if you are using a self-built or modified computer.
- When charging is finished, disconnect the AC Adaptor from the wall outlet (wall socket) or disconnect the USB cable from the camera. Not doing so may result in a shorter battery life.

### Remaining battery indicator

- The remaining battery indicator appears on the screen.



**A:** Battery level high  
**B:** Battery exhausted

- It takes about one minute for the correct remaining battery indicator to appear.
- The correct remaining battery indicator may not be displayed under some operating or environmental conditions.
- If the remaining battery indicator does not appear on the screen, press the DISP (Display Setting) button to display it.

### Charging time (Full charge)

The charging time is approximately 285 minutes using the AC adaptor (supplied).

The above charging time applies when charging a fully depleted battery pack at a temperature of 25 °C (77 °F). Charging may take longer depending on conditions of use and circumstances.

### Effective use of the battery pack



- Battery performance decreases in low temperature environments. So in cold places, the operational time of the battery pack is shorter. To ensure longer battery pack use, we recommend putting the battery pack in your pocket close to your body to warm it up, and insert it in the product immediately before you start shooting. If there are any metal objects such as keys in your pocket, be careful of causing a short-circuit.
- The battery pack will run down quickly if you use the flash or continuous shooting function frequently, turn the power on/off frequently, or set the monitor very bright.
- We recommend preparing spare battery packs and taking trial shots before taking the actual shots.
- If the battery terminal is dirty, you may not be able to turn on the product or the battery pack may not be properly charged. In that case, clean the battery by lightly wiping off any dust using a soft cloth or a cotton swab.

## **How to store the battery pack**

To maintain the battery pack's function, charge the battery pack and then fully discharge it in the camera at least once a year before storing it. Store the battery in a cool, dry place after removing it from the camera.

## **On battery life**

- The battery life is limited. If you use the same battery repeatedly, or use the same battery for a long period, the battery capacity decreases gradually. If the available time of the battery is shortened significantly, it is probably time to replace the battery pack with a new one.
- The battery life varies according to how the battery pack is stored and the operating conditions and environment in which each battery pack is used.

## Notes on charging the battery pack

---

- The supplied AC Adaptor is dedicated to this product. Do not connect with other electronic devices. Doing so may cause a malfunction.
- Make sure to use a genuine Sony AC Adaptor.
- If the product's charge lamp flashes while charging, remove the battery pack being charged, and then insert the same battery pack firmly back into the product. If the charge lamp flashes again, this may indicate a faulty battery or that a battery pack other than the specified type has been inserted. Check that the battery pack is the specified type. If the battery pack is the specified type, remove the battery pack, replace it with a new or different one and check that the newly inserted battery is charging correctly. If the newly inserted battery is charging correctly, the previously inserted battery may be faulty.
- If the charge lamp flashes even if the AC Adaptor is connected to the product and the wall outlet (wall socket), this indicates that charging has stopped temporarily and is on standby. Charging stops and enters standby status automatically when the temperature is outside of the recommended operating temperature. When the temperature returns to the appropriate range, charging resumes and the charge lamp lights up again. We recommend charging the battery pack in an ambient temperature of between 10°C to 30°C (50°F to 86°F).

Interchangeable Lens Digital Camera  
ILCE-7M3 α7III

## Inserting/removing a memory card

Explains how to insert a memory card (sold separately) to the product.

### 1 Open the memory card cover.

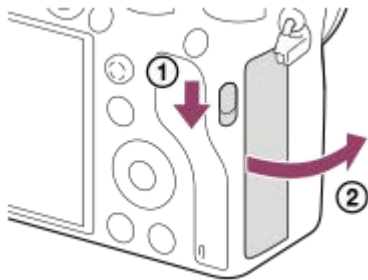

### 2 Insert the SD card into the slot 1.

- When using two memory cards, insert the second one into the slot 2.

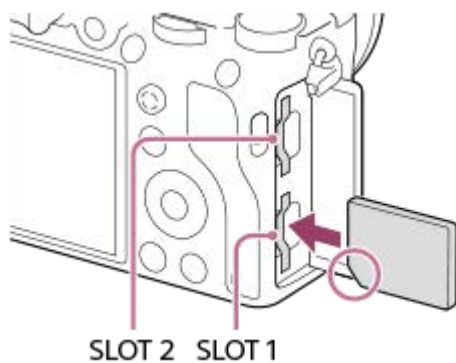

- With the notched corner facing in the direction illustrated, insert the memory card until it clicks into place. Insert the memory card correctly. Not doing so may cause a malfunction.



#### Memory card types that can be inserted into the memory card slots

Slot 1 (lower): Supports SD cards (compatible with UHS-I and UHS-II)

Slot 2 (upper): Supports SD cards (compatible with UHS-I) and Memory Stick PRO Duo media

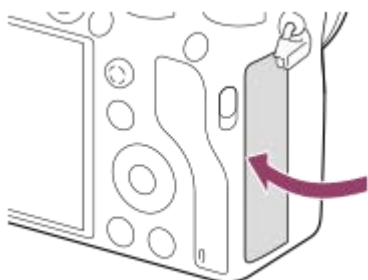
### 3 Close the cover.



- When you use a memory card with the camera for the first time, it is recommended that you format the card on the camera for more stable performance of the memory card.
- You can change the memory card slot for recording by selecting MENU →  (Setup) → [Rec. Media Settings] → [Prioritize Rec. Media].
- To record the same image on two memory cards at the same time or to sort recorded images onto two memory card slots by the image type (still image/movie), select MENU →  (Setup) → [Rec. Media Settings] → [Recording Mode].
- Use the slot 1 when you are only using one SD card.
- Use the slot 2 when you are using Memory Stick media. In this case, set [Prioritize Rec. Media] to [Slot 2].
- Do not insert a Memory Stick media into the slot 1. It may cause a malfunction.

## To remove the memory card

Open the memory card cover and make sure that the access lamp **(A)** is not lit, then push in the memory card lightly once to remove it.

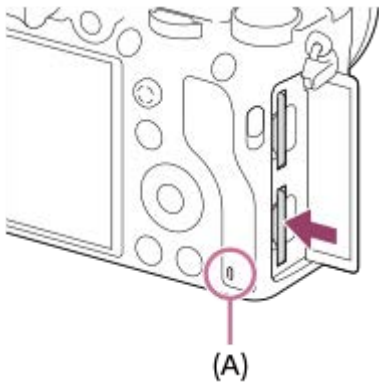

## Related Topic

- [Memory cards that can be used](#)
- [Notes on memory card](#)
- [Format](#)
- [Rec. Media Settings: Prioritize Rec. Media](#)
- [Selecting which memory card to play back \(Select PB Media\)](#)
- [Rec. Media Settings: Recording Mode](#)

Interchangeable Lens Digital Camera  
ILCE-7M3 α7III

## Memory cards that can be used

When using microSD memory cards or Memory Stick Micro media with this camera, be sure to use the appropriate adaptor.

### SD memory cards

Recording format		Supported memory card
Still image		SD/SDHC/SDXC card
AVCHD		SD/SDHC/SDXC card (Class 4 or faster, or U1 or faster)
XAVC S	4K 60Mbps* HD 50Mbps or lower* HD 60Mbps	SDHC/SDXC card (Class 10, or U1 or faster)
	4K 100Mbps* HD 100Mbps	SDHC/SDXC card (U3)





\* Including when recording proxy movies at the same time

### Memory Stick media

Recording format		Supported memory card
Still image		Memory Stick PRO Duo/ Memory Stick PRO-HG Duo
AVCHD		Memory Stick PRO Duo (Mark 2)/ Memory Stick PRO-HG Duo
XAVC S	4K 60Mbps* HD 50Mbps or lower* HD 60Mbps	Memory Stick PRO-HG Duo
	4K 100Mbps* HD 100Mbps	—

\* Including when recording proxy movies at the same time

#### Note

- Use the slot 1 when you are using a UHS-II memory card. Also, select MENU →  (Setup) → [Rec. Media Settings] → [Prioritize Rec. Media] → [Slot 1].
- Memory Stick PRO Duo media cannot be used in the slot 1.
- When an SDHC memory card is used to record an XAVC S movie over extended periods of time, the recorded movies will be divided into files 4 GB in size. The divided files can be handled as a single file by importing them to a computer using PlayMemories Home.
- When recording a movie on memory cards in both the slot 1 and the slot 2 with following camera settings, insert two memory cards with the same file system. XAVC S movies cannot be recorded simultaneously when using a combination of the exFAT file system and FAT32 file system.
  - [File Format] is set to [XAVC S 4K] or [XAVC S HD].
  - [Recording Mode] under [Rec. Media Settings] is set to [Simult. ()] or [Simult. (/ )].

Memory card
-------------

File system
-------------

Memory card	File system
SDXC memory card	exFAT
Memory Stick PRO Duo (Mark2), Memory Stick PRO-HG Duo, SDHC memory card	FAT32

- Fully charge the battery pack before attempting to recover the database files on the memory card.

---

### Related Topic

- [Notes on memory card](#)
- [Number of recordable images](#)
- [Recordable movie times](#)
- [Rec. Media Settings: Recording Mode](#)

## Notes on memory card

---

- If you repeatedly shoot and delete images for a long time, fragmentation of data in a file in the memory card may occur, and movie recording may be interrupted in the middle of shooting. If this happens, save your images to a computer or other storage location, then execute [Format] using this camera.
- Do not remove the battery pack or the memory card, disconnect the USB cable, or turn the camera off while the access lamp is lit up. This may cause the data on the memory card to become damaged.
- Be sure to back up the data for protection.
- Not all memory cards are guaranteed to operate correctly.
- Images recorded on an SDXC memory card cannot be imported to or played on computers or AV devices that are not compatible with exFAT when connected using a USB cable. Make sure that the device is compatible with exFAT before connecting it to the camera. If you connect your camera to an incompatible device, you may be prompted to format the card. Never format the card in response to this prompt, as doing so will erase all data on the card. (exFAT is the file system used on SDXC memory cards.)
- Do not expose the memory card to water.
- Do not strike, bend or drop the memory card.
- Do not use or store the memory card under the following conditions:
  - High temperature locations such as in a car parked under the sun
  - Locations exposed to direct sunlight
  - Humid locations or locations with corrosive substances present
- If the memory card is used near areas with strong magnetization, or used in locations subject to static electricity or electrical noise, the data on the memory card may become damaged.
- Do not touch the terminal section of the memory card with your hand or a metal object.
- Do not leave the memory card within the reach of small children. They might accidentally swallow it.
- Do not disassemble or modify the memory card.
- The memory card may be hot just after it has been used for a long time. Be careful when you handle it.
- Memory card formatted with a computer is not guaranteed to operate with the product. Format the memory card using this product.
- Data read/write speeds differ depending on the combination of the memory card and the equipment used.
- Do not press down hard when writing in the memo space on the memory card.
- Do not attach a label on the memory card itself nor on a memory card adaptor.
- If the write-protect switch or delete-protect switch of a memory card is set to the LOCK position, you cannot record or delete images. In this case, set the switch to the record position.
- To use a Memory Stick Micro media or microSD memory card with this product:
  - Be sure to insert the memory card into a dedicated adaptor. If you insert a memory card into the product without a memory card adaptor, you might not be able to remove it from the product.
  - When inserting a memory card into a memory card adaptor, be sure that the memory card is inserted in the correct direction and then insert it as far as it will go. If the card is not inserted properly, it may result in a malfunction.
- About Memory Stick PRO Duo media and Memory Stick PRO-HG Duo media:
  - This Memory Stick is equipped with MagicGate function. MagicGate is copyright protection technology that uses encryption technology.  
Data recording/playback that requires MagicGate functions cannot be performed with this product.
  - High-speed data transfer using a parallel interface is supported.

Interchangeable Lens Digital Camera  
ILCE-7M3 α7III

## Attaching/removing a lens

Turn off the camera before attaching or removing the lens.

- 1 Remove the body cap (A) from the camera and the rear lens cap (B) from the rear of the lens.

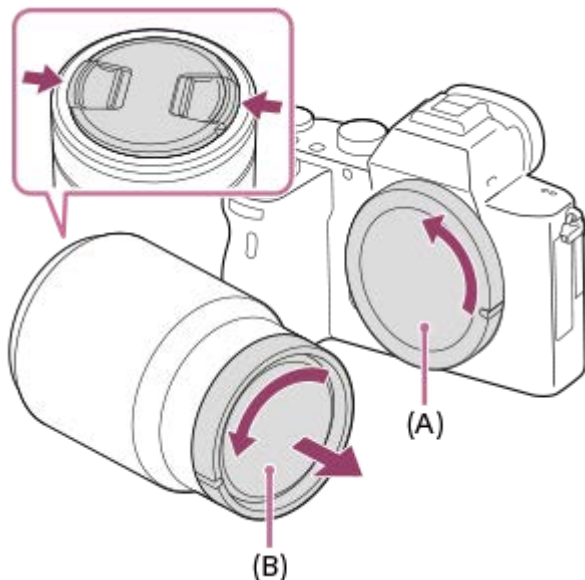

- It is recommended that you attach the front lens cap when you have done shooting.

- 2 Mount the lens by aligning the two white index marks (mounting indexes) on the lens and camera.

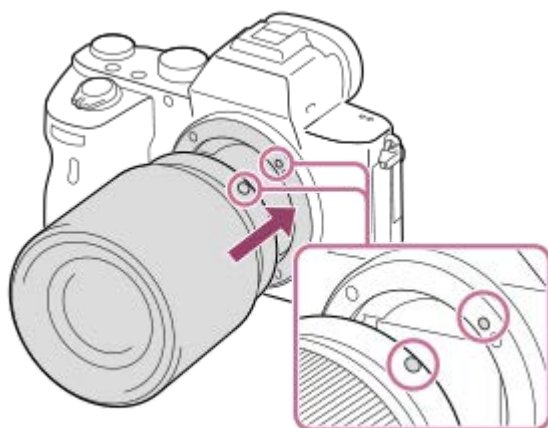

- Hold the camera with the lens mount facing down to prevent dust and debris from entering the camera.

- 3 While pushing the lens lightly toward the camera, turn the lens slowly in the direction of the arrow until it clicks into the locked position.



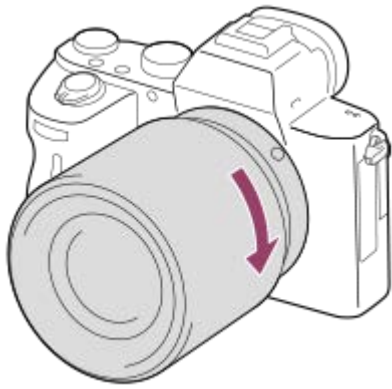

- Be sure to hold the lens straight when attaching it.

### To remove the lens

Keep pressing the lens release button **(A)** and turn the lens in the direction of the arrow until it stops. After removing the lens, attach the body cap to the camera and the lens caps to the front and rear of the lens to prevent dust and debris from entering the camera and lens.

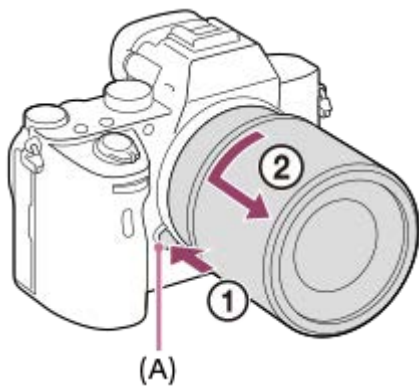

#### Note

- When attaching/removing the lens, work quickly in a dust-free location.
- Do not press the lens release button when attaching a lens.
- Do not use force when attaching a lens.
- A Mount Adaptor (sold separately) is required to use an A-mount lens (sold separately). When using the Mount Adaptor, refer to the operating manual supplied with the Mount Adaptor.
- If you want to shoot full-frame images, use a full-frame size compatible lens.
- When you use a lens with a tripod socket, attach a tripod to the tripod socket of the lens to help balance the weight of the lens.
- When carrying the camera with a lens attached, hold both the camera and the lens firmly.
- Do not hold the part of the lens that is extended for zoom or focus adjustment.

### Related Topic

- [Attaching the lens hood](#)

Interchangeable Lens Digital Camera  
ILCE-7M3 α7III

## Attaching the lens hood

We recommend that you use the lens hood to prevent light outside the shooting frame from affecting the image.

- 1 Match the shape of the lens hood mounting part and lens head, and turn the lens hood clockwise until it clicks.

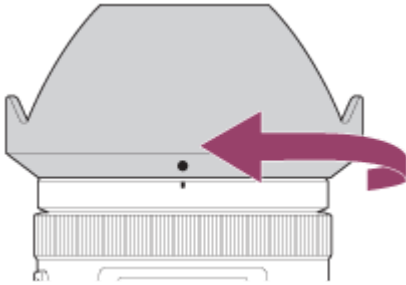

### Note

- Attach the lens hood properly. Otherwise, the lens hood may not have any effect or may be partially reflected in the image.
- When the lens hood is attached properly, the lens hood index (red line) matches the red index mark on the hood. (There may be no lens hood index on some lenses.)
- Remove the lens hood when using the flash as the lens hood blocks the flash light and may appear as a shadow on the image.
- To store the lens hood after shooting, attach the lens hood to the lens backward.

### Related Topic

- [Attaching/removing a lens](#)

Interchangeable Lens Digital Camera  
ILCE-7M3 α7III

## Mount Adaptor

Using a Mount Adaptor (sold separately), you can attach an A-mount lens (sold separately) to this product. For details, refer to the operating instructions supplied with the Mount Adaptor.

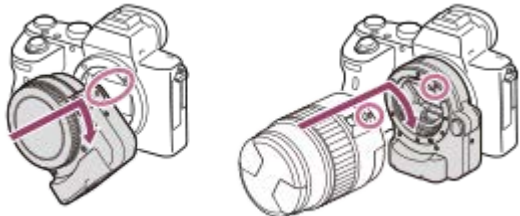

### Note

- When a setting other than [Continuous Shooting: Lo] is selected for [Cont. Shooting], the focus is locked during the first shot, even if [Focus Mode] is set to [Continuous AF].
- You may not be able to use the Mount Adaptor or auto-focus with certain lenses. Consult your Sony dealer or local authorized Sony service facility on compatible lenses.
- The LA-EA2 or LA-EA4 Mount Adaptor (sold separately) and the vertical grip (sold separately) are not designed to be attached at the same time. If you attach them at the same time, the space between the Mount Adaptor and the vertical grip will become narrow, making the camera difficult to hold.
- You cannot use the AF illuminator when using an A-mount lens.
- The sound of the lens and the product in operation may be recorded during movie recording. You can turn the sound off by selecting MENU →  2 (Camera Settings2) → [Audio Recording] → [Off].
- It may take a long time or may be difficult for the product to focus, depending on the lens used or the subject.

### Related Topic

- [LA-EA1/LA-EA3 Mount Adaptor](#)
- [LA-EA2/LA-EA4 Mount Adaptor](#)

Interchangeable Lens Digital Camera  
ILCE-7M3 α7III

## LA-EA1/LA-EA3 Mount Adaptor

---

If you use the LA-EA1 Mount Adaptor (sold separately) or LA-EA3 Mount Adaptor (sold separately), the following functions are available.

**Full frame shooting:**

LA-EA1: Not available

LA-EA3: Available with full frame shooting-compatible lenses only

**Autofocus:**

Available with SAM/SSM lens only

**AF system:**

Phase Detection AF/Contrast AF

**AF/MF select:**

Can be changed using the operating switch on the lens.

**Focus Mode:**

Single-shot AF/Continuous AF\*

\* This setting is unavailable when [ AF System] is set to [Contrast AF].

- When using a Mount Adaptor and the camera is set to movie mode, the Auto Focus only works when the shutter button is pressed halfway down or when the [AF On] function is active.
- When using a Mount Adaptor in movie mode, adjust the aperture manually.

**Available focus area:**

When [ AF System] is set to [Phase Detection AF]:

[Wide]/[Center]/[Flexible Spot]

When [ AF System] is set to [Contrast AF]:

[Wide]/[Zone]/[Center]/[Flexible Spot]/[Expand Flexible Spot]

**SteadyShot:**

In-body

---

**Related Topic**

- [Focus Area](#)

Interchangeable Lens Digital Camera  
ILCE-7M3 α7III

## LA-EA2/LA-EA4 Mount Adaptor

---

If you use the LA-EA2 Mount Adaptor (sold separately) or LA-EA4 Mount Adaptor (sold separately), the following functions are available.

**Full frame shooting:**

LA-EA2: Not available

LA-EA4: Available with full frame shooting-compatible lenses only

**Autofocus:**

Available

**AF system:**

Phase Detection AF, which is controlled by the dedicated AF sensor inside the Mount Adaptor

**AF/MF select:**

Lenses that do not support DMF (with a focus mode switch): Can be changed using the focus mode switch on the lens.

Lenses that support DMF (with a focus mode switch): Can be changed using the focus mode switch on the lens. When the focus mode switch on the lens is set to AF, you can change the focusing method by operating the camera.

Other lenses (without a focus mode switch): Can be changed by operating the camera.

**Focus Mode:**

LA-EA2: Single-shot AF/Continuous AF/DMF\*

LA-EA4: Single-shot AF/Continuous AF/Automatic AF/DMF\*

\* Only available when using lenses that support Direct Manual Focus.

- Even if [Priority Set in AF-S] is set to [Balanced Emphasis], it will temporarily switch to [AF].
- Even if [Priority Set in AF-C] is set to [Balanced Emphasis], it will temporarily switch to [Release].

**Available focus area:**

Wide/Center/Flexible Spot/Lock-on AF

**SteadyShot:**

In-body

Interchangeable Lens Digital Camera  
ILCE-7M3 α7III



## Vertical grip

You can attach a vertical grip (sold separately) to this product and record vertically oriented images. When attaching the vertical grip, remove the battery cover in advance. For details, refer to the operating instructions for the vertical grip.

### How to remove the battery cover

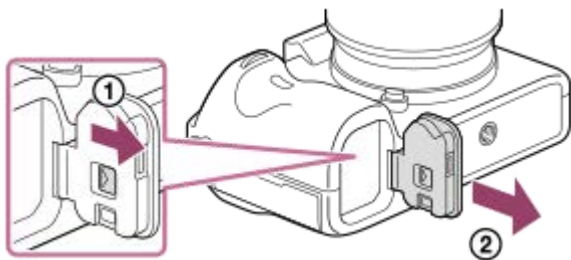
Slide the battery cover release lever of this product in the direction of the arrow.  
The shaft of the battery cover will be stored inside the battery cover.



- You can attach the removed battery cover to the vertical grip so that you do not lose it.
- When a vertical grip is attached to this product, the battery remaining is displayed as **1**  **2** .

### How to attach the battery cover

Slide the battery cover release lever and align the battery cover hinge with the battery cover shaft hole to attach the battery cover.

#### Hint

- The battery pack inside the vertical grip can be charged while the vertical grip is attached to the camera.  
Turn off the camera and connect the camera to the AC Adaptor (supplied) using the USB cable then connect the AC Adaptor to the wall outlet (wall socket).

#### Note

- The LA-EA2/LA-EA4 Mount Adaptor (sold separately) and the vertical grip are not designed to be attached at the same time. If you attach them at the same time, the space between the Mount Adaptor and the vertical grip will become narrow, making the camera difficult to hold.

Interchangeable Lens Digital Camera  
ILCE-7M3 α7III

## Setting language, date and time

The setting screen for language, date and time is displayed automatically when you turn on this product for the first time, initialize this product or when the internal rechargeable backup battery has discharged.

- 1 Turn on the camera.**

The language setting screen will appear and then setting screen for date and time will appear.
- 2 Select your language, and then press the center of the control wheel.**
- 3 Check that [Enter] is selected on the screen, then press the center.**
- 4 Select your desired geographic location, and then press the center.**
- 5 Select a setting item using the top/bottom side of the control wheel or by turning the control wheel, then press the center.**
- 6 Set [Daylight Savings], [Date/Time], and [Date Format] using the top/bottom/left/right sides, then press the center.**
  - Midnight is indicated as 12:00 AM, and noon as 12:00 PM when you set [Date/Time].
  - Change the values using the top/bottom when you set [Date/Time].
- 7 Repeat Steps 5 and 6 to set other items, then select [Enter] and press the center.**

### On maintaining the date and time

This camera has an internal rechargeable battery for maintaining the date and time and other settings regardless of whether the power is on or off, or whether the battery pack is charged or discharged.

To charge the internal rechargeable backup battery, insert a charged battery pack into the camera, and leave the product for 24 hours or more with the power off.

If the clock resets every time the battery pack is charged, the internal rechargeable backup battery may be worn out. Consult your service facility.

#### Hint

- To set the date and time or geographic location again after the date and time setting is finished, select MENU →  (Setup) → [Date/Time Setup] or [Area Setting].

#### Note

- If the date and time setting is canceled halfway, the setting screen for the date and time appears every time you turn on the camera.
- This camera does not have a function for inserting the date on images. You can insert the date on images and then save and print them using PlayMemories Home (for Windows only).

**Related Topic**

- [Date/Time Setup](#)
- [Area Setting](#)
- [Using the control wheel](#)

4-732-947-11(1) Copyright 2018 Sony Corporation





Interchangeable Lens Digital Camera  
ILCE-7M3 α7III

## In-Camera Guide

---

The [In-Camera Guide] displays descriptions of MENU items, Fn (Function) items, and settings.

Assign the [In-Camera Guide] function to the desired key in advance using [ Custom Key] or [ Custom Key].

**1** MENU → 2 (Camera Settings2) → [ Custom Key] or [ Custom Key] → desired key, then assign the [In-Camera Guide] function to the key.

- The [In-Camera Guide] function cannot be assigned to some keys.

**2** Select the MENU or Fn item of which you want to see descriptions, then press the button to which the [In-Camera Guide] function is assigned.

The descriptions of the item are displayed.

---

### Related Topic

- [Custom Key \(still image/movie/playback\)](#)

Interchangeable Lens Digital Camera  
ILCE-7M3 α7III

## Shooting still images

- 1 Select the desired shooting mode by turning the mode dial.

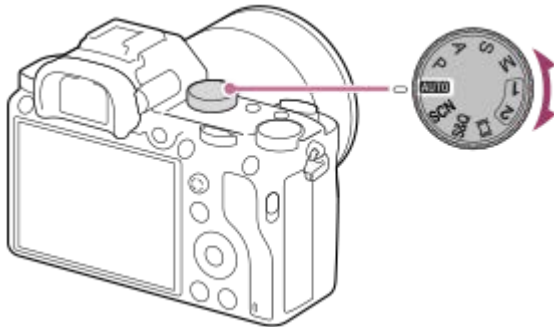

- 2 Adjust the monitor angle, and hold the camera. Or look through the viewfinder and hold the camera.

- 3 When a zoom lens is mounted, enlarge images by rotating the zoom ring.

- 4 Press the shutter button halfway down to focus.

When the image is in focus, a beep sounds and the indicator (such as ●) lights up.

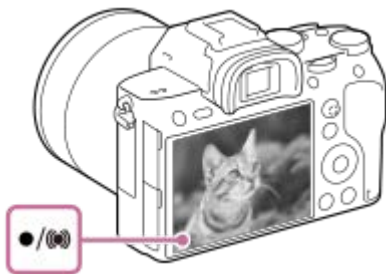

- 5 Press the shutter button fully down.

### To shoot images with the focus locked on the desired subject (Focus-lock)

Shoots images with the focus locked on the desired subject in auto focus mode.

1. MENU → 1 (Camera Settings1) → [Focus Mode] → [Single-shot AF] or [Automatic AF].
2. Place the subject within the AF area and press the shutter button halfway down.



The focus is locked.

- If it is difficult to focus on the desired subject, set [Focus Area] to [Center] or [Flexible Spot].

3. Keep pressing the shutter button halfway down, and place the subject back in the original position to re-compose the shot.



4. Press the shutter button down fully to take the picture.

#### Hint

- When the product cannot focus automatically, the focus indicator flashes and the beep does not sound. Either re-compose the shot or change the focus setting. In [Continuous AF] mode,  lights up and the beep indicating that the focus has been achieved does not sound.
- An icon indicating that data is being written is displayed after shooting. Do not remove the memory card while the icon is displayed.

#### Note

- When the subject is moving, you cannot lock the focus even if [Focus Mode] has been set to [Automatic AF].

---

#### Related Topic

- [List of mode dial function](#)
- [Clear Image Zoom/Digital Zoom \(Zoom\)](#)
- [Playing back still images](#)
- [Auto Review](#)
- [Focus Mode](#)
- [Focus Area](#)

Interchangeable Lens Digital Camera  
ILCE-7M3 α7III

## Focus Mode

Selects the focus method to suit the movement of the subject.

1 MENU →  1 (Camera Settings1) → [Focus Mode] → desired setting.

### Menu item details

#### **AF-S** (Single-shot AF):

The product locks the focus once focusing is complete. Use this when the subject is motionless.

#### **AF-A** (Automatic AF):

[Single-shot AF] and [Continuous AF] are switched according to the movement of the subject. When the shutter button is pressed halfway down, the product locks the focus when it determines that the subject is motionless, or continues to focus when the subject is in motion. During continuous shooting, the product automatically shoots with Continuous AF from the second shot.

#### **AF-C** (Continuous AF):

The product continues to focus while the shutter button is pressed and held halfway down. Use this when the subject is in motion. In [Continuous AF] mode, there is no beep when the camera focuses.

#### **DMF** (DMF):

You can make fine adjustments manually after performing auto focusing, letting you focus on a subject more quickly than when using the manual focus from the beginning. This is convenient in situations such as macro shooting.

#### **MF** (Manual Focus):

Adjusts the focus manually. If you cannot focus on the intended subject using auto focus, use manual focus.

### Focus indicator

 (lit):

The subject is in focus and the focus is locked.

 (flashing):

The subject is not in focus.

 (lit):

The subject is in focus. The focus will be adjusted continuously according to the movements of the subject.

 (lit):

Focusing is in progress.

### Subjects on which it is difficult to focus using auto focus

- Dark and distant subjects
- Subjects with poor contrast
- Subjects seen through glass
- Fast-moving subjects
- Reflective light or shiny surfaces
- Flashing light
- Back-lit subjects
- Continuously repetitive patterns, such as the facades of buildings
- Subjects in the focusing area with different focal distances

#### Hint

- In [Continuous AF] mode, you can lock the focus by pressing and holding the button that has been assigned the [Focus Hold] function.
- When you set the focus to infinity in the manual focus mode or the direct manual focus mode, make sure that the focus is on a sufficiently distant subject by checking the monitor or the viewfinder.

## Note

- [Automatic AF] is available only when you are using a lens that supports phase detection AF.
- When [Continuous AF] or [Automatic AF] is set, the angle of view may change little by little while focusing. This does not affect the actual recorded images.
- Only [Continuous AF] and [Manual Focus] are available when shooting movies or when the mode dial is set to **S&Q**.

---

## Related Topic

- [Direct manual focus \(DMF\)](#)
- [Manual Focus](#)
- [MF Assist \(still image\)](#)
- [Phase detection AF](#)

Interchangeable Lens Digital Camera  
ILCE-7M3 α7III

## Focus Area

Selects the focusing area. Use this function when it is difficult to focus properly in the auto focus mode.

1 MENU →  1 (Camera Settings1) → [Focus Area] → desired setting.

### Menu item details

#### Wide :

Focuses on a subject covering the whole range of the screen automatically. When you press the shutter button halfway down in the still image shooting mode, a green frame is displayed around the area that is in focus.

#### Zone :

Select a zone on the monitor on which to focus, and the product will automatically select a focus area.

#### Center :

Focuses automatically on a subject in the center of the image. Use together with the focus-lock function to create the composition you want.

#### Flexible Spot :

Allows you to move the focusing frame to a desired point on the screen and focus on an extremely small subject in a narrow area.

#### Expand Flexible Spot :

If the product cannot focus on a single selected point, it uses focus points around the flexible spot as a secondary priority area for focusing.

#### Lock-on AF :

When the shutter button is pressed and held halfway down, the product tracks the subject within the selected autofocus area. This setting is available only when the [Focus Mode] is set to [Continuous AF]. Point the cursor at [Lock-on AF] on the [Focus Area] setting screen, and then select the desired area to start tracking using the left/right sides of the control wheel. You can also move the tracking start area to the desired point by designating the area as a zone, flexible spot or expand flexible spot.

### Examples of the focusing frame display

The focusing frame differs as follows.

#### When focusing on a larger area

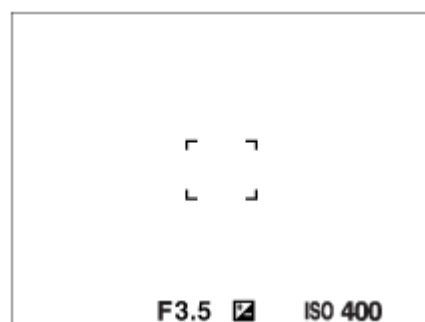

#### When focusing on a smaller area

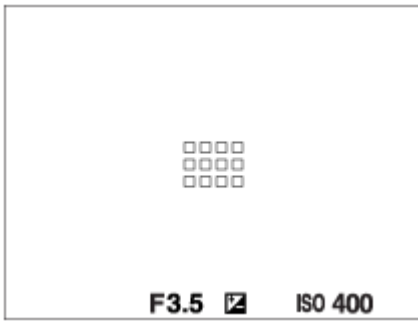

- When [Focus Area] is set to [Wide] or [Zone], the focusing frame may switch between “When focusing on a larger area” and “When focusing on a smaller area” depending on the subject or situation.
- When you attach an A-mount lens with a Mount Adaptor (LA-EA1 or LA-EA3) (sold separately) and [AF System] is set to [Phase Detection AF], the focusing frame for “When focusing on a smaller area” may be displayed.

### When focus is achieved automatically based on the whole range of the monitor

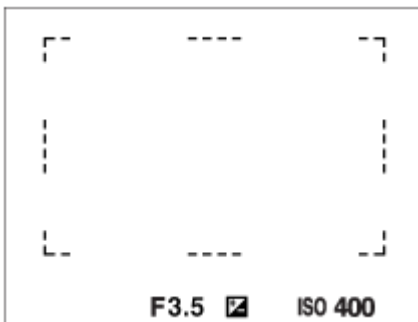

- When you use a zoom function other than the optical zoom, the [Focus Area] setting is disabled and the focusing frame is shown by the dotted line. The AF operates with priority on and around the center area.

### To move the focus area

- You can move the focus area in [Flexible Spot], [Expand Flexible Spot], or [Zone] by operating the multi-selector. If you assign [Focus Standard] to the center of the multi-selector beforehand, you can move the focusing frame back to the center of the monitor by pressing the center of the multi-selector.
- You can move the focusing frame quickly by touching and dragging it on the monitor. Set [Touch Operation] to [On] beforehand.

#### Hint

- In the default settings, [Focus Area] is assigned to the C2 button.

#### Note

- [Focus Area] is locked to [Wide] in the following situations:
  - [Intelligent Auto]
  - [Scene Selection]
- The focus area may not light up during continuous shooting or when the shutter button is pressed all the way down at once.
- When the mode dial is set to (Movie) or **S&Q** or during movie shooting, [Lock-on AF] cannot be selected as the [Focus Area].

### Related Topic

- [Touch Operation](#)
- [Adjusting the focus area settings to the camera's orientation \(horizontal/vertical\) \(Sw. V/H AF Area\)](#)

- [Registering the current focus area \(AF Area Regist.\) \(still image\)](#)

4-732-947-11(1) Copyright 2018 Sony Corporation





Interchangeable Lens Digital Camera  
ILCE-7M3 α7III

## Phase detection AF

---

When there are phase detection AF points within the auto focus area, the product uses the combined autofocus of the phase detection AF and contrast AF.

### Note

- Phase detection AF is available only when an applicable lens is attached. If you use a lens that does not support phase detection AF, you cannot use [Automatic AF], [ AF Track Sens], [ AF Track Sens] or [ AF drive speed]. Also, even if you use a previously purchased applicable lens, the phase detection AF might not function unless you update the lens. For details on compatible lenses, visit the Sony web site in your area, or consult your Sony dealer or local authorized Sony service facility.

---



### Related Topic

- [AF System \(still image\)](#)

## Focus Standard

If you assign [Focus Standard] to the desired custom key, you can recall useful functions such as focusing on a subject in the center of the screen automatically in accordance with the focus area settings.

**1** MENU →  2 (Camera Settings2) → [ Custom Key] → desired key, then assign the [Focus Standard] function to the key.

- To use the [Focus Standard] function while shooting movies, select MENU →  2 (Camera Settings2) → [ Custom Key] → the desired button, and then assign [Focus Standard] to the key.

**2** Press the key to which [Focus Standard] is assigned.

- What you can do by pressing the key varies depending on the settings for [Focus Area] and [Center Lock-on AF].

### When [Focus Area] is set to [Zone], [Flexible Spot] or [Expand Flexible Spot]:

Pressing the key moves the focusing frame back to the center.

### When [Focus Area] is set to [Wide] or [Center]:

- When [Center Lock-on AF] is set to [On], [Center Lock-on AF] is activated by pressing the key. The camera detects the subject positioned in the center of the screen and starts tracking by pressing the center of the control wheel while [Center Lock-on AF] is activated.
- When [Center Lock-on AF] is set to [Off], the camera focuses on the center point.

### Note

- You cannot set the [Focus Standard] function to [Left Button], [Right Button] or [Down Button].

### Related Topic

- [Custom Key \(still image/movie/playback\)](#)
- [Focus Area](#)
- [Center Lock-on AF](#)

Interchangeable Lens Digital Camera  
ILCE-7M3 α7III

## Focus Settings

---

Configures the focus functions using the front dial/rear dial or the control wheel.

- 1 MENU →  1 (Camera Settings1) → [Focus Settings].
- 2 Perform settings using the front/rear dial or control wheel.

### When the focus mode is set to auto focus or Direct Manual Focus

You can adjust the focus area settings and the position of the focusing frame. The focusing frame can be moved only when the [Focus Area] is set to the following:

- [Zone]
- [Flexible Spot]
- [Expand Flexible Spot]

**Front dial:** Moves the focusing frame up/down.

**Rear dial:** Moves the focusing frame right/left.

**Control wheel:** Selects the focus area.

### When the focus mode is set to Manual Focus

You can set the area to be magnified when focusing manually.

**Front dial:** Moves the area to be magnified up/down.



**Rear dial:** Moves the area to be magnified right/left.

**Control wheel:** Moves the area to be magnified up/down.

Interchangeable Lens Digital Camera  
ILCE-7M3 α7III

## Adjusting the focus area settings to the camera's orientation (horizontal/vertical) (Sw. V/H AF Area)

You can set whether to switch the [Focus Area] and the position of the focusing frame according to the orientation of the camera (horizontal/vertical). This function is useful when shooting scenes for which you have to change the camera position frequently, such as portraits or sports scenes.

1 MENU →  (Camera Settings1) → [ Swt. V/H AF Area] → desired setting.

### Menu item details

#### Off:

Does not switch the [Focus Area] and the position of the focusing frame according to the orientation of the camera (horizontal/vertical).

#### AF Point Only:

Switches the position of the focusing frame according to the orientation of the camera (horizontal/vertical). The [Focus Area] is fixed.

#### AF Point + AF Area:

Switches both the [Focus Area] and the position of the focusing frame according to the orientation of the camera (horizontal/vertical).

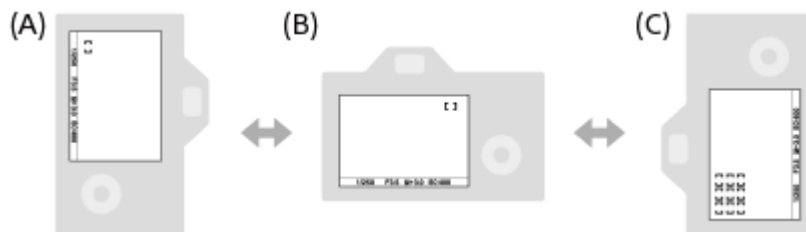

### An example when [AF Point + AF Area] is selected



- (A) Vertical: [Flexible Spot] (Upper left corner)  
 (B) Horizontal: [Flexible Spot] (Upper right corner)  
 (C) Vertical: [Zone] (Lower left corner)

- Three camera orientations are detected: horizontal, vertical with the side of the shutter button facing up, and vertical with the side of the shutter button facing down.

### Note

- If the setting for [ Swt. V/H AF Area] is changed, the focus settings for each camera orientation will not be retained.
- The [Focus Area] and the position of the focusing frame will not change even when [ Swt. V/H AF Area] is set to [AF Point + AF Area] or [AF Point Only] in the following situations:
  - When the shooting mode is set to [Intelligent Auto], [Movie], or [S&Q Motion]
  - While the shutter button is pressed halfway down
  - During movie shooting
  - While using the digital zoom function
  - While the auto-focusing is activated
  - When [Focus Settings] are activated
  - During continuous shooting
  - During the countdown for the self-timer
  - When [Focus Magnifier] is activated

- When you shoot images right after the power is turned on and the camera is vertical, the first shot is taken with the horizontal focus setting or with the last focus setting.
- The orientation of the camera cannot be detected when the lens is facing up or down.

---

---

### Related Topic

- [Focus Area](#)

4-732-947-11(1) Copyright 2018 Sony Corporation

Interchangeable Lens Digital Camera  
ILCE-7M3 α7III

## AF/MF control

---

You can easily switch the focusing mode from auto to manual and vice versa while shooting without changing your holding position.

- 1 MENU →  2 (Camera Settings2) → [ Custom Key] or [ Custom Key] → desired button → [AF/MF Control Hold] or [AF/MF Ctrl Toggle].

### Menu item details

#### AF/MF Control Hold :

Switches the focusing mode while the button is held down.

#### AF/MF Ctrl Toggle :

Switches the focusing mode until the button is pressed again.

#### Note

- You cannot set the [AF/MF Control Hold] function to [Left Button], [Right Button] or [Down Button] of the control wheel.

---

### Related Topic



- [Custom Key \(still image/movie/playback\)](#)

Interchangeable Lens Digital Camera  
ILCE-7M3 α7III

## AF w/ shutter (still image)

---

Selects whether to focus automatically when you press the shutter button halfway down. Select [Off] to adjust the focus and the exposure separately.

1 MENU →  1 (Camera Settings1) → [ AF w/ shutter] → desired setting.

### Menu item details

#### On:





The auto focus operates when you press the shutter button halfway down.

#### Off:

The auto focus does not operate even if you press the shutter button halfway down.

### Useful method to micro-adjust the focus

When an A-mount lens is attached, activating the auto focus function with a button other than the shutter button lets you focus more precisely in combination with manual focusing.

1. Set [ AF w/ shutter] to [Off].
2. MENU →  2 (Camera Settings2) → [ Custom Key] or [ Custom Key] → assign the [Focus Magnifier] functions to the desired keys.
3. Set [ Eye-Start AF] to [Off] to avoid auto focusing when you look through the viewfinder.
4. Press the AF-ON button to focus.
5. Press the key to which the [Focus Magnifier] function is assigned, and then rotate the focus ring for micro-adjustments of the focus.
6. Press the shutter button fully down to shoot the image.

---

### Related Topic

- [AF On](#)
- [Eye-Start AF \(still image\)](#)
- [Pre-AF \(still image\)](#)
- [Focus Magnifier](#)

Interchangeable Lens Digital Camera  
ILCE-7M3 α7III





## AF On

---

You can focus without pressing the shutter button halfway down. The settings for [Focus Mode] will be applied.

- 1 Press the AF-ON (AF On) button while shooting in autofocus mode.

### Hint

- Set [  AF w/ shutter ] to [Off] when you do not want to perform auto focusing using the shutter button.
- Set [  AF w/ shutter ], [  Pre-AF ], and [  Eye-Start AF ] to [Off] to focus at a specific shooting distance predicting the position of the subject.

---

### Related Topic

- [Custom Key \(still image/movie/playback\)](#)
- [AF w/ shutter \(still image\)](#)
- [Pre-AF \(still image\)](#)
- [Eye-Start AF \(still image\)](#)



Interchangeable Lens Digital Camera  
ILCE-7M3 α7III

## Eye AF

The camera focuses on the subject's eyes while you keep the button pressed.

- 1 **MENU** →  2 (Camera Settings2) → [ Custom Key] → desired key, then assign the [Eye AF] function to the key.
- 2 **Point the camera at a person's face, and press the button to which you have assigned the [Eye AF] function.**
- 3 **Press the shutter button while pressing the button.**

### Hint

- When the camera focuses on the eyes, a detection frame is displayed over the eyes. If the focus mode is set to [Single-shot AF], or it is set to [Automatic AF] and the subject is not moving, the frame will disappear after a period of time.

### Note

- If the camera cannot detect a person's face, you cannot use [Eye AF].
- Depending on the circumstances, you cannot use [Eye AF] such as when [Focus Mode] is set to [Manual Focus].
- The [Eye AF] function may not function very well in the following situations:
  - When the person is wearing sunglasses.
  - When the front hair covers the person's eyes.
  - In low-light or back-lit conditions.
  - When the eyes are closed.
  - When the person is in the shade.
  - When the person is out of focus.
  - When the person is moving too much.
- If the person is moving too much, the detection frame may not display correctly over their eyes.
- When the mode dial is set to  (Movie) or **S&Q**, or during movie recording, [Eye AF] is unavailable.

### Related Topic

- [Custom Key \(still image/movie/playback\)](#)

## Set. Face Prty in AF

Sets whether the camera focuses on detected faces with higher priority in the auto-focus mode.

1 MENU →  (Camera Settings1) → [Set. Face Prty in AF] → [Face Priority in AF] → desired setting.

### Menu item details

#### On:

The camera focuses on detected faces with higher priority.

#### Off:

The camera focuses without face detection.

### Face Dtct Frame Dsp

Sets whether to display the face detection frame when [Face Priority in AF] is set to [On].

1. MENU →  (Camera Settings1) → [Set. Face Prty in AF] → [Face Dtct Frame Dsp] → desired setting.

#### On:

Displays the face detection frame when [Face Priority in AF] is set to [On].

#### Off:

Does not display the face detection frame.

### Face Detection frame

- When the product detects a face, the gray face detection frame appears. When the product determines that autofocus is enabled, the face detection frame turns white.
- In case you have registered the priority order for each face using [Face Registration], the product automatically selects the first prioritized face and the face detection frame over that face turns white. The face detection frames of other registered faces turn reddish-purple.

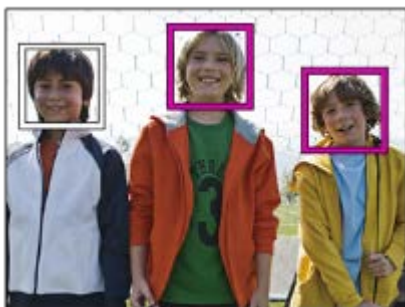



#### Hint

- When [Set. Face Prty in AF] is set to [On] and the focus mode is set to [Single-shot AF], a detection frame is displayed over the eyes when the camera focuses on eyes. The frame displayed over the eyes will disappear after a period of time.

#### Note

- You cannot use the face detection function with the following functions:
  - Other zoom functions than the optical zoom
  - [Posterization] under [Picture Effect]
  - [Focus Magnifier]

- Movie shooting with [  Record Setting] set to [120p]/[ 100p].
- When [  Frame Rate] is set to [120fps]/[100fps] during slow-motion/quick-motion shooting.
- Up to 8 faces of your subjects can be detected.
- Even if [Face Dtct Frame Dsp] is set to [Off], a green focusing frame will be displayed over faces that are in focus.
- When the shooting mode is set to [Intelligent Auto], [Face Priority in AF] is locked to [On].
- The product may not detect faces at all or may accidentally detect other objects as faces in some conditions.

---

### Related Topic

- [Face Registration \(New Registration\)](#)
- [Face Registration \(Order Exchanging\)](#)

Interchangeable Lens Digital Camera  
ILCE-7M3 α7III

## AF in Focus Mag. (still image)

You can focus on the subject more accurately using auto-focus by magnifying the area where you want to focus. While the magnified image is displayed, you can focus on a smaller area than the flexible spot.

- 1 MENU → 1 (Camera Settings1) → [ AF in Focus Mag.] → [On].
- 2 MENU → 1 (Camera Settings1) → [Focus Magnifier].
- 3 **Magnify the image by pressing the center of the multi-selector, and then adjust the position by pressing the multi-selector up/down/left/right.**
  - The magnification scale changes each time you press the center.
- 4 **Press the shutter button halfway down to focus.**
  - The focus will be achieved at point of in the center of the screen.
- 5 **Press the shutter button all the way down to shoot.**
  - The camera exits the magnified display after shooting.

### Hint

- Use of a tripod is recommended to accurately identify the location you want to magnify.
- You can check the auto-focusing result by magnifying the displayed image. If you want to readjust the focus position, adjust the focus area on the magnified screen and then press the shutter button halfway down.

### Note

- If you enlarge an area at the edge of the screen, the camera may not be able to focus.
- The exposure and white balance cannot be adjusted while the displayed image is being magnified.
- [ AF in Focus Mag.] is unavailable in the following situations:
  - During movie shooting
  - When [Focus Mode] is set to [Continuous AF].
  - When [Focus Mode] is set to [Automatic AF] and the shooting mode is set to other than P/A/S/M.
  - When [Focus Mode] is set to [Automatic AF] and [Drive Mode] is set to [Cont. Shooting].
  - When using a Mount Adaptor (sold separately).
- While the displayed image is being magnified, the following functions are unavailable:
  - [Eye AF]
  - [Center Lock-on AF]
  - [ Eye-Start AF]
  - [ Pre-AF]
  - [Face Priority in AF]

---

---

## Related Topic

- [Focus Magnifier](#)
- [Custom Key \(still image/movie/playback\)](#)

4-732-947-11(1) Copyright 2018 Sony Corporation

Interchangeable Lens Digital Camera  
ILCE-7M3 α7III

## Center Lock-on AF

When you press the center of the control wheel, the camera detects the subject positioned in the center of the screen and continues to track the subject.

1 MENU →  (Camera Settings1) → [Center Lock-on AF] → [On].

2 Align the target frame (A) over the subject and press the center of the control wheel.

- Press the center again to stop tracking.

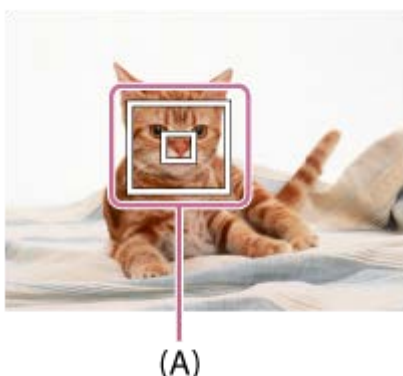



3 Press the shutter button fully down to shoot the image.

### Hint

- If you assign the [Focus Standard] function to the key of your choice, you can activate [Center Lock-on AF] or detect a subject again by pressing the key when [Focus Area] is set to [Wide] or [Center].
- You can select the subject to be tracked by touch operation when shooting using the monitor. Set [Touch Operation] to [On], and select [Touch Panel+Pad] or [Touch Panel Only] under [Touch Panel/Pad].

### Note

- The [Center Lock-on AF] function may not function very well in the following situations:
  - The subject is moving too quickly.
  - The subject is too small, or too large.
  - The contrast between the subject and the background is poor.
  - It is dark.
  - The ambient light changes.
- Lock-on AF does not work in the following situations:
  - When shooting in Manual Focus mode.
  - When using the digital zoom
  - When shooting movies with [  Record Setting] set to [120p]/[100p]
  - When shooting slow/quick motion movies with [  Frame Rate] set to [120fps]/[100fps].





Interchangeable Lens Digital Camera  
ILCE-7M3 α7III

## Focus Hold

---

Locks the focus while the key to which the Focus Hold function has been assigned is pressed.

- 1 MENU →  2 (Camera Settings 2) → [ Custom Key] or [ Custom Key] → assign the [Focus Hold] function to the key of your choice.
  - 2 Focus and press the key to which the [Focus Hold] function has been assigned.
  - 3 Press the shutter button while holding down the key.
- 

### Related Topic



- [Custom Key \(still image/movie/playback\)](#)





## Registering the current focus area (AF Area Regist.) (still image)

You can move the focusing frame to a preassigned position temporarily using a custom key. This function is useful when shooting scenes in which the subject's movements are predictable; for example, sports scenes. With this function, you can switch the focus area quickly according to the situation.

### How to register focus area

1. MENU →  1 (Camera Settings1) → [ AF Area Regist.] → [On].
2. Set the focus area to the desired position and then hold down the Fn (Function) button.



### How to call up the registered focus area

1. MENU →  2 (Camera Settings2) → [ Custom Key] → desired key, then select [Regist. AF Area hold].
2. Set the camera to the shooting mode, hold down the key to which [Regist. AF Area hold] has been assigned and then press the shutter button to shoot images.

#### Hint

- When a focusing frame is registered using [ AF Area Regist.], the registered focusing frame flashes on the monitor.
- If you assign [Regist AF Area toggle] to a custom key, you can use the registered focusing frame without holding down the key.
- If [Reg. AF Area+AF On] is assigned to a custom key, auto focusing using the registered focusing frame is performed when the key is pressed.

#### Note

- A focus area cannot be registered in the following situations:
  - The mode dial is set to either  (Movie) or **S&Q**
  - While [Touch Focus] is being performed
  - While using the digital zoom function
  - While [Lock-on AF] is being performed
  - While focusing
  - While performing focus lock
- You cannot assign [Regist. AF Area hold] to [Left Button], [Right Button], or [Down Button].
- You cannot call up the registered focus area in the following situations:
  - The mode dial is set to either **AUTO** (Auto Mode),  (Movie) or **S&Q**
- When [ AF Area Regist.] is set to [On], the [Lock Operation Parts] setting is locked to [Off].

### Related Topic

- [Focus Area](#)
- [Custom Key \(still image/movie/playback\)](#)

Interchangeable Lens Digital Camera  
ILCE-7M3 α7III

## Deleting a registered AF Area (Del. Reg. AF Area)

---

Deletes the focusing frame position that was registered using [ AF Area Regist.].

**1** MENU →  (Camera Settings1) → [ Del. Reg. AF Area].

---

### Related Topic

- [Registering the current focus area \(AF Area Regist.\) \(still image\)](#)

Interchangeable Lens Digital Camera  
ILCE-7M3 α7III

## Pre-AF (still image)

---

The product automatically adjusts focus before you press the shutter button halfway down. During focusing operations, the screen may shake.

1 MENU →  1 (Camera Settings1) → [ Pre-AF] → desired setting.

### Menu item details

**On:**

Adjusts focus before you press the shutter button halfway down.

**Off:**

Does not adjust focus before you press the shutter button halfway down.

**Note**



- [ Pre-AF] is available only when an E-mount lens is mounted.

Interchangeable Lens Digital Camera  
ILCE-7M3 α7III

## Eye-Start AF (still image)

---

Sets whether or not to use autofocus when you look through an Electronic Viewfinder.

1 MENU →  (Camera Settings1) → [ Eye-Start AF] → desired setting.

### Menu item details

**On:**

Auto focusing starts when you look through the Electronic Viewfinder.

**Off:**

Auto focusing does not start when you look through the Electronic Viewfinder.

#### Hint



- [ Eye-Start AF] is available when an A-mount lens and a Mount Adaptor (LA-EA2, LA-EA4) (sold separately) are attached.

Interchangeable Lens Digital Camera  
ILCE-7M3 α7III

## AF Track Sens (still image)

---

You can select the AF track sensitivity when the subject goes out of focus in still image mode.

**1** MENU →  1 (Camera Settings1) → [ AF Track Sens] → **desired setting.**

### Menu item details

**5(Responsive) / 4 / 3(Standard) / 2 / 1(Locked on):**

Select [5(Responsive)] to focus responsively on subjects at different distances.

Select [1(Locked on)] to keep the focus on a specific subject when other things are crossing in front of the subject.

Interchangeable Lens Digital Camera  
ILCE-7M3 α7III

## Priority Set in AF-S

---

Sets whether to release the shutter even if the subject is not in focus when [Focus Mode] is set to [Single-shot AF], [DMF] or [Automatic AF] and the subject is remaining still.

1 MENU →  (Camera Settings1) → [Priority Set in AF-S] → desired setting.

### Menu item details

**AF:**

Prioritizes focusing. The shutter will not be released until the subject is in focus.

**Release:**

Prioritizes the shutter's release. The shutter will be released even if the subject is out of focus.

**Balanced Emphasis:**

Shoots with a balanced emphasis on both focusing and shutter release.

---

### Related Topic

- [Focus Mode](#)
- [Priority Set in AF-C](#)

Interchangeable Lens Digital Camera  
ILCE-7M3 α7III

## Priority Set in AF-C

---

Sets whether to release the shutter even if the subject is not in focus when the continuous AF is activated and the subject is in motion.

1 MENU →  1 (Camera Settings1) → [Priority Set in AF-C] → desired setting.

### Menu item details

**AF:**

Prioritizes focusing. The shutter will not be released until the subject is in focus.

**Release:**

Prioritizes the shutter's release. The shutter will be released even if the subject is out of focus.

**Balanced Emphasis:**

Shoots with a balanced emphasis on both focusing and shutter release.

---



### Related Topic

- [Focus Mode](#)
- [Priority Set in AF-S](#)

Interchangeable Lens Digital Camera  
ILCE-7M3 α7III

## AF Illuminator (still image)

The AF illuminator supplies fill light to focus more easily on a subject in dark surroundings. In the time between pressing the shutter button halfway down and locking the focus, the red AF illuminator lights up to allow the camera to focus easily.

1 MENU →  1 (Camera Settings1) → [ AF Illuminator] → desired setting.

### Menu item details



#### Auto:

The AF illuminator lights up automatically in dark surroundings.

#### Off:

Does not use the AF illuminator.

#### Note

- You cannot use [ AF Illuminator] in the following situations:
  - When the shooting mode is [Movie] or [S&Q Motion].
  - When [Focus Mode] is set to [Continuous AF] or [Automatic AF] and the subject is moving (when the focus indicator  or  lights up).
  - When [Focus Magnifier] is activated.
  - When [Scene Selection] is set to the following modes:
    - [Landscape]
    - [Sports Action]
    - [Night Scene]
  - When a Mount Adaptor is attached.
- If the Multi Interface Shoe is equipped with a flash with an AF illuminator function, when the flash is turned on, the AF illuminator will turn on as well.
- The AF illuminator emits a very bright light. Although there is no health hazard, do not look directly into the AF illuminator at close range.



Interchangeable Lens Digital Camera  
ILCE-7M3 α7III

## AF Area Auto Clear

---

Sets whether the focus area should be displayed all the time or should disappear automatically shortly after focus is achieved.

**1** MENU →  1 (Camera Settings1) → [AF Area Auto Clear] → desired setting.

### Menu item details

**On:**

The focus area disappears automatically shortly after focus is achieved.

**Off:**

The focus area is displayed all the time.

Interchangeable Lens Digital Camera  
ILCE-7M3 α7III

## Disp. cont. AF area

You can set whether or not to display the area that is in focus when [Focus Area] is set to [Wide] or [Zone], in [Continuous AF] mode.

1 MENU →  1 (Camera Settings1) → [Disp. cont. AF area] → desired setting.

### Menu item details

#### On:

Displays the focus area that is in focus.

#### Off:

Does not display the focus area that is in focus.

#### Note

- When [Focus Area] is set to one of the following, the focusing frames in the area that is in focus turn green:
  - [Center]
  - [Flexible Spot]
  - [Expand Flexible Spot]
- When an A-mount lens and a Mount Adaptor (LA-EA1/LA-EA3) (sold separately) are mounted on the camera and [  AF System] is set to [Phase Detection AF], [Disp. cont. AF area] is always turned on regardless of the [Focus Area] settings.

Interchangeable Lens Digital Camera  
ILCE-7M3 α7III

## AF Micro Adj.

Allows you to adjust the auto-focusing position and register an adjusted value for each lens when using A-mount lenses with an LA-EA2 or LA-EA4 Mount Adaptor (sold separately).

Use this function only when adjustments are needed. Note that the auto focus function may not be performed at a proper position when using this adjustment.

1 MENU →  1 (Camera Settings1) → [AF Micro Adj.].

2 Select [AF Adjustment Set.] → [On].

3 [amount] → desired value.

- The larger the value you select, the farther the autofocused position will be from the product. The smaller the value you select, the closer the autofocused position will be to the product.

### Hint

- It is recommended that you adjust the position under actual shooting conditions. Set [Focus Area] to [Flexible Spot] and use a bright subject with high contrast when you adjust.



### Note

- When you attach a lens for which you have already registered a value, the registered value appears on the screen. [±0] appears for lenses for which a value has not yet been registered.
- If [-] is displayed as the value, then a total of 30 lenses have been registered and no new lens can be registered. To register a new lens, attach a lens for which the registration can be erased, and set its value to [±0], or reset the values of all the lenses using [Clear].
- The [AF Micro Adj.] supports Sony, Minolta, or Konica-Minolta lenses. If you perform [AF Micro Adj.] with lenses other than the supported lenses, the registered settings for the supported lenses may be affected. Do not perform [AF Micro Adj.] with an unsupported lens.
- You cannot set [AF Micro Adj.] individually for a Sony, Minolta, and Konica-Minolta lens of the same specification.

Interchangeable Lens Digital Camera  
ILCE-7M3 α7III

## AF System (still image)

Sets the focus detection system (Phase Detection AF/Contrast AF) when you attach an A-mount lens using an LA-EA1/LA-EA3 Mount Adaptor (sold separately).

1 MENU →  1 (Camera Settings1) →  AF System → desired setting.

### Menu item details



#### Phase Detection AF:

Focuses with Phase Detection AF. The focusing speed is very fast.

#### Contrast AF:

Always focuses with Contrast AF. The focusing speed is slower. Use when you cannot focus with [Phase Detection AF].

#### Note

- When [ AF System] is set to [Contrast AF], [Continuous AF] under [Focus Mode] is unavailable.
- The following functions are unavailable when [ AF System] is set to [Phase Detection AF]:
  - [Zone], [Expand Flexible Spot], and [Lock-on AF] in [Focus Area]
  - [Center Lock-on AF]
- When [ AF System] is set to [Phase Detection AF], [Priority Set in AF-S] will temporarily switch to [AF] even if it is set to [Balanced Emphasis].

## Manual Focus

---

When it is difficult to focus properly in the autofocus mode, you can adjust the focus manually.

**1** MENU →  1 (Camera Settings1) → [Focus Mode] → [Manual Focus].

**2** Rotate the focusing ring to achieve sharp focus.

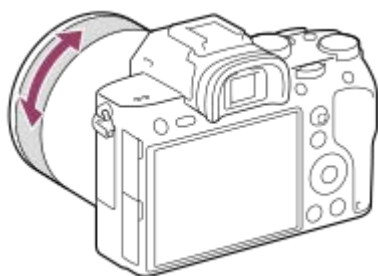

- When you rotate the focusing ring, the focus distance is displayed on the screen.  
The focus distance is not displayed when the Mount Adaptor (sold separately) is attached.

**3** Press the shutter button fully down to shoot an image.

### Note

- When you use the viewfinder, adjust the diopter level to obtain the correct focus on the viewfinder.

---

### Related Topic

- [Focus Magnifier](#)
- [Peaking Setting](#)
- [MF Assist \(still image\)](#)

Interchangeable Lens Digital Camera  
ILCE-7M3 α7III

## Direct manual focus (DMF)

You can make fine adjustments manually after performing auto focusing, letting you focus on a subject more quickly than when using the manual focus from the beginning. This is convenient in situations such as macro shooting.

1 MENU →  1 (Camera Settings1) → [Focus Mode] → [DMF].

2 Press the shutter button halfway down to focus automatically.

3 Keep the shutter button pressed halfway down, and then rotate the focusing ring to achieve a sharper focus.

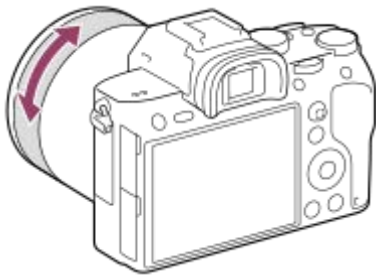

- When you rotate the focusing ring, the focus distance is displayed on the screen.  
The focus distance is not displayed when the Mount Adaptor (sold separately) is attached.

4 Press the shutter button fully down to shoot an image.

### Related Topic









- [Peaking Setting](#)

Interchangeable Lens Digital Camera  
ILCE-7M3 α7III

## Focus Magnifier

You can check the focus by enlarging the image before shooting.

Unlike with [ MF Assist], you can magnify the image without operating the focus ring.

- 1 MENU →  (Camera Settings1) → [Focus Magnifier].
- 2 Press the center of the multi-selector to enlarge the image and select the area you want to enlarge by pressing the multi-selector up/down/left/right.
  - Each time you press the center, the magnification scale will change.
  - You can set the initial magnification by selecting MENU →  (Camera Settings1) → [ Initial Focus Mag.].
- 3 Confirm the focus.
  - Press the  (Delete) button to bring the magnified position into the center of an image.
  - When the focus mode is [Manual Focus], you can adjust the focus while an image is magnified. If [ AF in Focus Mag.] is set to [Off], the [Focus Magnifier] function is canceled when the shutter button is pressed halfway down.
  - When the shutter button is pressed halfway down while an image is magnified during the auto-focusing, different functions are performed depending on the [ AF in Focus Mag.] setting.
    - When [ AF in Focus Mag.] is set to [On]: Auto-focusing is performed again.
    - When [ AF in Focus Mag.] is set to [Off]: The [Focus Magnifier] function is canceled.
  - You can set how long the image is to be shown magnified by selecting MENU →  (Camera Settings1) → [Focus Magnif. Time].
- 4 Press the shutter button fully down to shoot the image.

### To use the focus magnifier function by touch operation

You can magnify the image and adjust the focus by touching the monitor. Set [Touch Operation] to [On] beforehand.

Then, select the appropriate settings under [Touch Panel/Pad]. When the focus mode is [Manual Focus], you can perform [Focus Magnifier] by double-tapping the area to focus on while shooting with the monitor.

While shooting with the viewfinder, a frame is displayed in the center of the monitor by double-tapping and you can move the frame by dragging it. The image is magnified by pressing the center of the control wheel.

#### Hint

- While using the focus magnifier function, you can move the magnified area by dragging it on the touch panel.
- To exit the focus magnifier function, double-tap the monitor again. When [ AF in Focus Mag.] is set to [Off], the focus magnifier function is ended by pressing the shutter button halfway down.

#### Related Topic

- [MF Assist \(still image\)](#)
- [Focus Magnif. Time](#)
- [Initial Focus Mag. \(still image\)](#)

- AF in Focus Mag. (still image)
- Custom Key (still image/movie/playback)
- Touch Operation

4-732-947-11(1) Copyright 2018 Sony Corporation



Interchangeable Lens Digital Camera  
ILCE-7M3 α7III

## MF Assist (still image)

Enlarges the image on the screen automatically to make manual focusing easier. This works in Manual Focus or Direct Manual Focus shooting.

1 MENU →  1 (Camera Settings1) → [ MF Assist] → [On].



2 Turn the focus ring to adjust the focus.

- The image is enlarged. You can magnify images further by pressing the center of the control wheel.

### Hint

- You can set how long the image is to be shown magnified by selecting MENU →  1 (Camera Settings1) → [Focus Magnif. Time].

### Note

- You cannot use [ MF Assist] when shooting movies. Use the [Focus Magnifier] function instead.
- [ MF Assist] is not available when a Mount Adaptor is attached. Use the [Focus Magnifier] function instead.

### Related Topic

- [Manual Focus](#)
- [Direct manual focus \(DMF\)](#)
- [Focus Magnif. Time](#)

Interchangeable Lens Digital Camera  
ILCE-7M3 α7III

## Focus Magnif. Time

---

Set the duration for which an image is to be magnified using the [ MF Assist] or [Focus Magnifier] function.

**1** MENU →  1 (Camera Settings1) → [Focus Magnif. Time] → desired setting.

### Menu item details

**2 Sec:**

Magnifies the images for 2 seconds.

**5 Sec:**

Magnifies the images for 5 seconds.

**No Limit:**

Magnifies the images until you press the shutter button.

---

### Related Topic



- [Focus Magnifier](#)
- [MF Assist \(still image\)](#)

Interchangeable Lens Digital Camera  
ILCE-7M3 α7III

## Initial Focus Mag. (still image)

---

Sets the initial magnification scale when using [Focus Magnifier]. Select a setting that will help you frame your shot.

1 MENU →  1 (Camera Settings1) → [ Initial Focus Mag.] → desired setting.

### Menu item details

#### Full-frame shooting

**x1.0:**

Displays the image with the same magnification as the shooting screen.

**x5.9:**

Displays a 5.9-times enlarged image.

#### APS-C/Super 35mm size shooting

**x1.0:**

Displays the image with the same magnification as the shooting screen.

**x3.8:**

Displays a 3.8-times enlarged image.

---

### Related Topic

- [Focus Magnifier](#)

Interchangeable Lens Digital Camera  
ILCE-7M3 α7III

## Peaking Setting

---

Sets the peaking function, which enhances the outline of in-focus areas during shooting with Manual Focus or Direct Manual Focus.

1 MENU →  1 (Camera Settings1) → [Peaking Setting] → desired setting.

### Menu item details

#### Peaking Display:

Sets whether to display peaking.

#### Peaking Level:

Sets the level of enhancement of in-focus areas.

#### Peaking Color:

Sets the color used to enhance in-focus areas.

#### Note

- Since the product recognizes sharp areas as in focus, the effect of peaking differs, depending on the subject and lens.
- The outline of in-focus ranges is not enhanced on devices connected via HDMI.

---



### Related Topic

- [Manual Focus](#)
- [Direct manual focus \(DMF\)](#)

Interchangeable Lens Digital Camera  
ILCE-7M3 α7III

## Drive Mode

Select the appropriate mode for the subject, such as single shooting, continuous shooting or bracketing shooting.

- 1 Select  /  (Drive Mode) on the control wheel → desired setting.
  - You can also set the drive mode by selecting MENU →  1 (Camera Settings1) → [Drive Mode].
- 2 Select the desired mode using the right/left side of the control wheel.

### Menu item details

#### Single Shooting:

Normal shooting mode.

#### Cont. Shooting:

Shoots images continuously while you press and hold down the shutter button.

#### Self-timer:

Shoots an image using the self-timer after a designated number of seconds have elapsed since the shutter button was pressed.

#### Self-timer(Cont):

Shoots a designated number of images using the self-timer after a designated number of seconds have elapsed since the shutter button was pressed.

#### BRK C Cont. Bracket:

Shoots images while holding the shutter button down, each with different degrees of exposure.

#### BRK S Single Bracket:

Shoots a specified number of images, one by one, each with a different degrees of exposure.

#### BRK WB WB bracket:

Shoots a total of three images, each with different color tones according to the selected settings for white balance, color temperature and color filter.

#### BRK DRO DRO Bracket:

Shoots a total of three images, each at a different degree of D-Range Optimizer.

#### Note

- When the shooting mode is set to [Scene Selection] and [Sports Action] is selected, [Single Shooting] cannot be performed.



### Related Topic

- [Cont. Shooting](#)
- [Self-timer](#)
- [Self-timer\(Cont\)](#)
- [Cont. Bracket](#)
- [Single Bracket](#)
- [WB bracket](#)
- [DRO Bracket](#)

Interchangeable Lens Digital Camera  
ILCE-7M3 α7III

## Cont. Shooting

Shoots images continuously while you press and hold down the shutter button.

- 1 Select  /  (Drive Mode) of the control wheel → [Cont. Shooting].
  - You can also set the continuous shooting by selecting MENU →  1 (Camera Settings1) → [Drive Mode].
- 2 Select the desired mode using the right/left side of the control wheel.

### Menu item details

#### Continuous Shooting: Hi+ :

Images are shot continuously at the maximum speed while you press and hold down the shutter button.

#### Continuous Shooting: Hi / Continuous Shooting: Mid / Continuous Shooting: Lo:

Subjects are easier to track because the subject is displayed in real-time on the monitor or viewfinder during shooting.

### Number of still images recordable with continuous shooting

The following table shows estimated numbers of recordable still images with [Drive Mode] set to [Continuous Shooting: Hi+]. The numbers may vary depending on the shooting conditions and the memory card.

#### JPEG Image Size]: [L:24M]

JPEG Standard	Approx. 177 images
JPEG Fine	Approx. 172 images
JPEG Extra fine	Approx. 163 images
RAW (Compressed RAW)	Approx. 89 images
RAW & JPEG (Compressed RAW)*	Approx. 79 images
RAW (Uncompressed RAW)	Approx. 40 images
RAW & JPEG (Uncompressed RAW)*	Approx. 36 images

\*  JPEG Quality] when [RAW & JPEG] is selected: [Fine]

#### Hint

- To continuously adjust the focus and exposure during continuous shooting, set as follows:
  - [Focus Mode]: [Continuous AF]
  -  AEL w/ shutter]: [Off] or [Auto]

#### Note

- The shooting speed during continuous shooting becomes slower when  RAW File Type] is set to [Uncompressed].
- The shooting speed during continuous shooting becomes slower when [e-Front Curtain Shut.] is set to [Off] in [Continuous Shooting: Hi], [Continuous Shooting: Mid] or [Continuous Shooting: Lo] mode.

- When the F-value is greater than F11 in [Continuous Shooting: Hi+], [Continuous Shooting: Hi] or [Continuous Shooting: Mid] mode, the focus is locked to the setting in the first shot.
- The subject is not displayed in real-time on the monitor or viewfinder when shooting in [Continuous Shooting: Hi+] mode.
- Continuous shooting is unavailable in the following situations:
  - The shooting mode is set to [Scene Selection] and a scene other than [Sports Action] is selected.
  - [Picture Effect] is set to [Rich-tone Mono.].
  - [DRO/Auto HDR] is set to [Auto HDR].

---

### Related Topic

- [Displaying continuous shooting remaining time indicator \(Cont. Shoot. Length\)](#)
- [Focus Mode](#)
- [AEL w/ shutter \(still image\)](#)

Interchangeable Lens Digital Camera  
ILCE-7M3 α7III

## Displaying continuous shooting remaining time indicator (Cont. Shoot. Length)

Sets whether to display an indicator of the remaining time for which continuous shooting can be performed at the same shooting speed.

1 MENU →  2 (Camera Settings2) → [Cont. Shoot. Length] → desired setting.

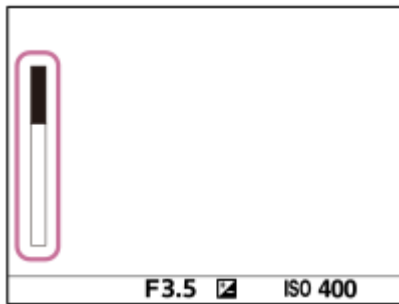

### Menu item details

#### Always Display:

Always displays the indicator when the drive mode is set to [Cont. Shooting].

#### Shoot.-Only Display:

Displays the indicator only while continuous shooting is performed.

#### Not Displayed:

Does not display the indicator.

#### Hint

- When the internal camera memory for buffering is full, "SLOW" will be displayed and the continuous shooting speed will decrease.

### Related Topic

- [Cont. Shooting](#)



Interchangeable Lens Digital Camera  
ILCE-7M3 α7III

## Self-timer

Shoots an image using the self-timer after a designated number of seconds have elapsed since the shutter button was pressed. Use the 5-second/10-second self-timer when you are going to be in the picture, and use the 2-second self-timer to reduce camera-shake caused by pressing the shutter button.

**1** Press  /  (Drive Mode) of the control wheel → [Self-timer].

- You can also set the drive mode by selecting MENU →  1 (Camera Settings1) → [Drive Mode].

**2** Select the desired mode using the right/left side of the control wheel.

**3** Adjust the focus and shoot the image.

The self-timer lamp flashes, a beep sounds, and a picture is taken after the designated number of seconds have elapsed.

### Menu item details







The mode determines the number of seconds until a picture is taken after the shutter button is pressed.

 10 Self-timer: 10 Sec

 5 Self-timer: 5 Sec

 2 Self-timer: 2 Sec

#### Hint

- Press the shutter button again or press  /  on the control wheel to stop the count of the self-timer.
- Press  /  on the control wheel and select  (Single Shooting) to cancel the self-timer.
- Set [Audio signals] to [Off] to mute the beep sound during self-timer counting.
- To use the self-timer in bracket mode, select bracket mode under drive mode, then select MENU →  1 (Camera Settings1) → [Bracket Settings] → [Selftimer during Brkt].

#### Note

- The self-timer is unavailable in the following situations:
  - [Sports Action] under [Scene Selection]

### Related Topic

- [Audio signals](#)

Interchangeable Lens Digital Camera  
ILCE-7M3 α7III

## Self-timer(Cont)

Shoots a designated number of images using the self-timer after a designated number of seconds have elapsed since the shutter button was pressed. You can choose the best from multiple shots.

**1** Press  /  (Drive Mode) of the control wheel → [Self-timer(Cont)].

- You can also set the drive mode by selecting MENU →  1 (Camera Settings1) → [Drive Mode].

**2** Select the desired mode using the right/left side of the control wheel.

**3** Adjust the focus and shoot the image.

The self-timer lamp flashes, a beep sounds, and pictures are taken after the designated number of seconds has elapsed. The designated number of pictures are taken continuously.

### Menu item details

For example, three images are shot when 10 seconds have elapsed after the shutter button is pressed when [Self-timer(Cont.): 10 Sec. 3 Img.] is selected.

 <sup>3</sup>/<sub>10s</sub> Self-timer(Cont.): 10 Sec. 3 Img.

 <sup>5</sup>/<sub>10s</sub> Self-timer(Cont.): 10 Sec. 5 Img.

 <sup>3</sup>/<sub>5s</sub> Self-timer(Cont.): 5 Sec. 3 Img.

 <sup>5</sup>/<sub>5s</sub> Self-timer(Cont.): 5 Sec. 5 Img.

 <sup>3</sup>/<sub>2s</sub> Self-timer(Cont.): 2 Sec. 3 Img.

 <sup>5</sup>/<sub>2s</sub> Self-timer(Cont.): 2 Sec. 5 Img.



#### Hint

- Press the shutter button again or press  /  on the control wheel to stop the count of the self-timer.
- Press  /  on the control wheel and select  (Single Shooting) to cancel the self-timer.

Interchangeable Lens Digital Camera  
ILCE-7M3 α7III

## Cont. Bracket

Shoots multiple images while automatically shifting the exposure from base to darker and then to lighter. You can select an image that suits your purpose after recording.

- 1 Press  /  (Drive Mode) of the control wheel → [Cont. Bracket].**
  - You can also set the drive mode by selecting MENU →  1 (Camera Settings1) → [Drive Mode].
- 2 Select the desired mode using the right/left side of the control wheel.**
- 3 Adjust the focus and shoot the image.**
  - The base exposure is set at the first shot.
  - Keep pressing and holding the shutter button until bracket shooting is finished.

### Menu item details

For example, the camera shoots a total of three images continuously with an exposure value shifted by plus or minus 0.3 EV when [Cont. Bracket: 0.3EV 3 Image] is selected.

#### Note

- The last shot is shown on the auto review.
- When [ISO AUTO] is selected in [Manual Exposure] mode, the exposure is changed by adjusting the ISO value. If a setting other than [ISO AUTO] is selected, the exposure is changed by adjusting the shutter speed.
- When the exposure is compensated, the exposure is shifted based on the compensated value.
- Bracket shooting is unavailable in the following shooting modes:
  - [Intelligent Auto]
  - [Scene Selection]
- When the flash is used, the product performs flash bracket shooting, which shifts the amount of flash light even if [Cont. Bracket] is selected. Press the shutter button for each image.

### Related Topic



- [Bracket Settings](#)
- [Indicator during bracket shooting](#)

Interchangeable Lens Digital Camera  
ILCE-7M3 α7III

## Single Bracket

Shoots multiple images while automatically shifting the exposure from base to darker and then to lighter. You can select the image that suits your purpose after recording.

Since a single picture is taken each time you press the shutter button, you can adjust the focus or the composition for each shot.

- 1 Select  /  (Drive Mode) of the control wheel → [Single Bracket].**
  - You can also set the drive mode by selecting MENU →  1 (Camera Settings1) → [Drive Mode].
- 2 Select the desired mode using the right/left side of the control wheel.**
- 3 Adjust the focus and shoot the image.**
  - Press the shutter button for each image.

### Menu item details

For example, when [Single Bracket: 0.3EV 3 Image] is selected, three images are shot one at a time with the exposure value shifted up and down in increments of 0.3 EV.

#### Note

- When [ISO AUTO] is selected in [Manual Exposure] mode, the exposure is changed by adjusting the ISO value. If a setting other than [ISO AUTO] is selected, the exposure is changed by adjusting the shutter speed.
- When the exposure is compensated, the exposure is shifted based on the compensated value.
- Bracket shooting is unavailable in the following shooting modes:
  - [Intelligent Auto]
  - [Scene Selection]

### Related Topic

- [Bracket Settings](#)
- [Indicator during bracket shooting](#)

## Indicator during bracket shooting

### Viewfinder

#### Ambient light\* bracketing

3 images shifted by 0.3 EV steps

Exposure compensation ±0.0 EV



### Monitor (Display All Info. or Histogram)

#### Ambient light\* bracketing

3 images shifted by 0.3 EV steps

Exposure compensation ±0.0 EV



#### Flash bracketing

3 images shifted by 0.7 EV steps

Flash compensation -1.0 EV

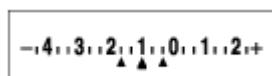

### Monitor (For viewfinder)

#### Ambient light\* bracketing (upper indicator)

3 images shifted by 0.3 EV steps

Exposure compensation ±0.0 EV

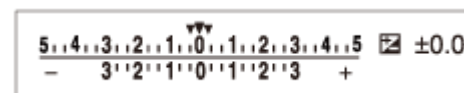

#### Flash bracketing (lower indicator)

3 images shifted by 0.7 EV steps

Flash compensation -1.0 EV



\* Ambient light: A generic term for non-flash light including natural light, electric bulb and fluorescent lighting. Whereas the flash light blinks for a moment, ambient light is constant, so this kind of light is called "ambient light."

### Note



- During bracket shooting, guides equal to the number of images to be shot are displayed over/under the bracket indicator.
- When you start single bracket shooting, the guides will disappear one by one as the camera records images.



Interchangeable Lens Digital Camera  
ILCE-7M3 α7III

## WB bracket

Shoots a total of three images, each with different color tones according to the selected settings for white balance, color temperature and color filter.

- 1 Select  /  (Drive Mode) of the control wheel → [WB bracket].
  - You can also set the drive mode by selecting MENU →  1 (Camera Settings1) → [Drive Mode].
- 2 Select the desired mode using the right/left side of the control wheel.
- 3 Adjust the focus and shoot the image.

### Menu item details

#### White Balance Bracket: Lo:

Records a series of three images with small changes in the white balance (within the range of 10MK<sup>-1\*</sup>).

#### White Balance Bracket: Hi:

Records a series of three images with large changes in the white balance (within the range of 20MK<sup>-1\*</sup>).

\* MK<sup>-1</sup> is the unit that indicates the capability of color temperature conversion filters and indicates the same value as "mired."

#### Note

- The last shot is shown on the auto review.

### Related Topic



- [Bracket Settings](#)

Interchangeable Lens Digital Camera  
ILCE-7M3 α7III

## DRO Bracket

---

You can record a total of three images, each at a different degree of D-Range Optimizer value.

- 1 Select  /  (Drive Mode) of the control wheel → [DRO Bracket].
  - You can also set the drive mode by selecting MENU →  1 (Camera Settings1) → [Drive Mode].
- 2 Select the desired mode using the right/left side of the control wheel.
- 3 Adjust the focus and shoot the image.

### Menu item details

#### DRO Bracket: Lo:

Records a series of three images with small changes in the D-Range Optimizer value (Lv 1, Lv 2, and Lv 3).

#### DRO Bracket: Hi:

Records a series of three images with large changes in the D-Range Optimizer value (Lv 1, Lv 3, and Lv 5).

#### Note

- The last shot is shown on the auto review.

---

### Related Topic

- [Bracket Settings](#)







Interchangeable Lens Digital Camera  
ILCE-7M3 α7III

## Bracket Settings

---

You can set the self-timer in bracket shooting mode, and the shooting order for exposure bracketing and white balance bracketing.

- 1 Select  /  (Drive Mode) of the control wheel → select bracket shooting mode.
  - You can also set the drive mode by selecting MENU →  1 (Camera Settings1) → [Drive Mode].
- 2 MENU →  1 (Camera Settings1) → [Bracket Settings] → desired setting.

### Menu item details

#### Selftimer during Brkt:

Sets whether to use the self-timer during bracket shooting. Also sets the number of seconds until the shutter is released if using the self-timer.

(OFF/2 Sec/5 Sec/10 Sec)

#### Bracket order:

Sets the order of exposure bracketing and white balance bracketing.

(0→-→+/-→0→+)

---

### Related Topic

- [Cont. Bracket](#)
- [Single Bracket](#)
- [WB bracket](#)
- [DRO Bracket](#)

Interchangeable Lens Digital Camera  
ILCE-7M3 α7III

## Touch Operation

---

Sets whether or not to activate touch operations on the monitor.

**1** MENU →  (Setup) → [Touch Operation] → desired setting.

### Menu item details

**On:**

Activates the touch operation.

**Off:**

Deactivates the touch operation.

---

### Related Topic

- [Touch Focus](#)
- [Touch Pad Settings](#)
- [Touch Panel/Pad](#)

Interchangeable Lens Digital Camera  
ILCE-7M3 α7III

## Touch Panel/Pad

---

Touch operations when shooting with the monitor are referred to as "touch panel operations," and touch operations when shooting with the viewfinder are referred to as "touch pad operations." You can select whether to activate touch panel operations or touch pad operations.

1 MENU →  (Setup) → [Touch Panel/Pad] → desired setting.

### Menu item details

**Touch Panel+Pad:**

Activates both the touch panel operations when shooting with the monitor and touch pad operations when shooting with the viewfinder.

**Touch Panel Only:**

Activates only the touch panel operations when shooting with the monitor.

**Touch Pad Only:**

Activates only the touch pad operations when shooting with the viewfinder.

---

### Related Topic

- [Touch Operation](#)

Interchangeable Lens Digital Camera  
ILCE-7M3 α7III

## Touch Focus

You can select a subject on which to focus using touch operations in the still image and movie recording modes.

1 MENU →  (Setup) → [Touch Operation] → [On].

### Specifying the position where you want to focus in the still image mode

You can focus on the desired position by touching the monitor.

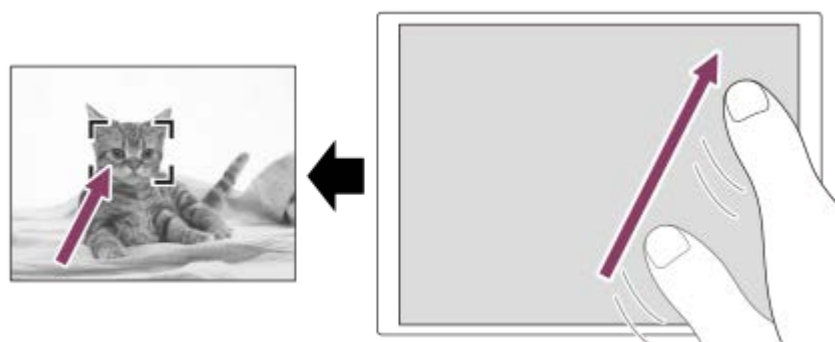

1. Select a [Focus Area] other than [Flexible Spot] or [Expand Flexible Spot].
2. MENU →  1 (Camera Settings1) → [Center Lock-on AF] → [Off].
3. Touch the monitor.
  - When shooting with the monitor, touch the subject to focus.
  - When shooting with the viewfinder, you can move the position of the focus by touching and dragging on the monitor while looking through the viewfinder.



- When the shutter button is pressed halfway down, the camera focuses on the focusing frame. Press the shutter button all the way down to shoot images.
- To cancel focusing with touch operations, touch  or press the center of the control wheel if shooting with the monitor, and press the center of the control wheel if shooting with the viewfinder.

### Specifying the position where you want to focus in the movie recording mode (spot focus)

The camera will focus on the touched subject. Spot focus is not available when shooting with the viewfinder.

1. Select a [Focus Area] other than [Flexible Spot] or [Expand Flexible Spot].
2. MENU →  1 (Camera Settings1) → [Center Lock-on AF] → [Off].
3. Touch the subject on which you want to focus before or during recording.
  - When you touch the subject, the focus mode temporarily switches to manual focus and the focus can be adjusted using the focus ring.
  - To cancel spot focus, touch  or press the center of the control wheel.

#### Hint

- In addition to the touch focus function, touch operations such as the following are also available.
  - When [Focus Area] is set to [Flexible Spot] or [Expand Flexible Spot], the focusing frame can be moved using touch operations.
  - When the [Focus Mode] is set to [Manual Focus], the focus magnifier can be used by double-tapping the monitor.

#### Note

- The touch focus function is not available in the following situations:
  - When [Focus Mode] is set to [Manual Focus].
  - When using the digital zoom
  - When using the LA-EA2 or LA-EA4
  - When using the LA-EA1 or LA-EA3, and the shooting mode is set to Movie

---

### Related Topic

- [Touch Operation](#)
- [Touch Panel/Pad](#)

4-732-947-11(1) Copyright 2018 Sony Corporation

Interchangeable Lens Digital Camera  
ILCE-7M3 α7III

## Touch Pad Settings

You can adjust settings related to touch pad operations during viewfinder shooting.

1 MENU →  (Setup) → [Touch Pad Settings] → desired setting.

### Menu item details

#### Operation in V Orient.:

Sets whether to enable touch pad operations during vertically oriented viewfinder shooting. You can prevent erroneous operations during vertically oriented shooting caused by your nose, etc. touching the monitor.

#### Touch Pos. Mode:

Sets whether to move the focusing frame to the position touched on the screen ([Absolute Position]), or move the focusing frame to the desired position based on the direction of dragging and the amount of movement ([Relative Position]).

#### Operation Area:

Sets the area to be used for touch pad operations. Restricting the operational area can prevent erroneous operations caused by your nose, etc. touching the monitor.

### About Touch Positioning Mode

Selecting [Absolute Position] lets you move the focusing frame to a distant position more quickly because you can directly specify the position of the focusing frame with touch operations.

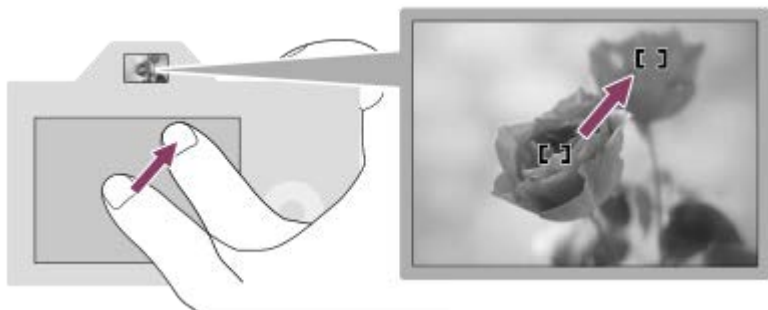

Selecting [Relative Position] lets you operate the touch pad from wherever is easiest, without having to move your finger over a wide area.

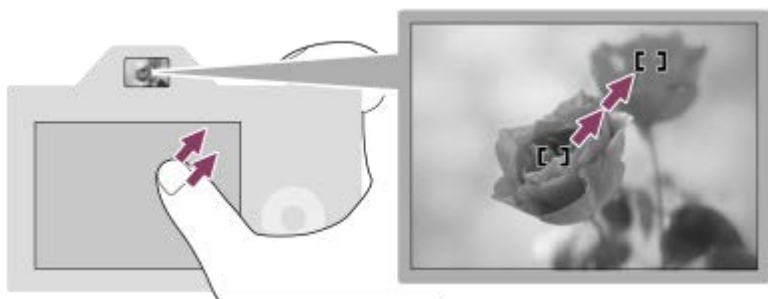

#### Hint

- In touch pad operations when [Touch Pos. Mode] is set to [Absolute Position], the area set in [Operation Area] is treated as the entire screen.

---

---

## Related Topic



- [Touch Operation](#)

4-732-947-11(1) Copyright 2018 Sony Corporation

Interchangeable Lens Digital Camera  
ILCE-7M3 α7III

## JPEG Image Size (still image)

The larger the image size, the more detail will be reproduced when the image is printed on large-format paper. The smaller the image size, the more images can be recorded.

1 MENU →  (Camera Settings1) → [ JPEG Image Size] → desired setting.

### Menu item details

When [  Aspect Ratio] is set to 3:2	
L: 24M	6000×4000 pixels
M: 10M	3936×2624 pixels
S: 6.0M	3008×2000 pixels

When [  Aspect Ratio] is set to 16:9	
L: 20M	6000×3376 pixels
M: 8.7M	3936×2216 pixels
S: 5.1M	3008×1688 pixels

### When recording in the APS-C-equivalent size

When [  Aspect Ratio] is set to 3:2	
L: 10M	3936×2624 pixels
M: 6.0M	3008×2000 pixels
S: 2.6M	1968×1312 pixels

When [  Aspect Ratio] is set to 16:9	
L: 8.7M	3936×2216 pixels
M: 5.1M	3008×1688 pixels
S: 2.2M	1968×1112 pixels

#### Note

- When [ File Format] is set to [RAW] or [RAW & JPEG], the image size for RAW images corresponds to "L."



- Aspect Ratio (still image)



4-732-947-11(1) Copyright 2018 Sony Corporation

Interchangeable Lens Digital Camera  
ILCE-7M3 α7III

## JPEG Quality (still image)

---

Selects the JPEG image quality when [ File Format] is set to [RAW & JPEG] or [JPEG].

**1** MENU →  1 (Camera Settings1) → [ JPEG Quality] → **desired setting.**

### Menu item details

#### Extra fine/Fine/Standard:

Since the compression rate increases from [Extra fine] to [Fine] to [Standard], the file size decreases in the same order. This allows more files to be recorded on one memory card, but the image quality is lower.

---



### Related Topic

- [File Format \(still image\)](#)

Interchangeable Lens Digital Camera  
ILCE-7M3 α7III

## Aspect Ratio (still image)

---

① MENU →  1 (Camera Settings1) → [ Aspect Ratio] → desired setting.

### Menu item details

**3:2:**

Same aspect ratio as 35 mm plate film

**16:9:**



An aspect ratio suitable for viewing on a TV that supports high definition

Interchangeable Lens Digital Camera  
ILCE-7M3 α7III

## File Format (still image)

---

Sets the file format for still images.

1 MENU →  1 (Camera Settings1) → [ File Format] → desired setting.

### Menu item details

#### RAW:

Images before processing are recorded in this file format. Select this format to process images on a computer for professional purposes.



#### RAW & JPEG:

A RAW image and a JPEG image are created at the same time. This is suitable when you need two image files, a JPEG for viewing, and a RAW for editing.

#### JPEG:

The image is recorded in the JPEG format.

### About RAW images

- To open a RAW image file recorded with this camera, the software Imaging Edge is needed. With Imaging Edge, you can open a RAW image file, then convert it into a popular image format such as JPEG or TIFF, or readjust the white balance, saturation or contrast of the image.
- You cannot apply [Auto HDR] or [Picture Effect] functions with RAW images.
- RAW images recorded with this camera have a resolution of 14 bits per pixel. However, resolution is limited to 12 bits in the following shooting modes:
  - [ Long Exposure NR]
  - [BULB]
  - [Cont. Shooting] when [ RAW File Type] is set to [Compressed]
- You can set whether RAW images are compressed or uncompressed using [ RAW File Type].

#### Note

- If you do not intend to edit the images on your computer, we recommend that you record in JPEG format.
- You cannot add DPOF (print order) registration marks to RAW images.

---

### Related Topic



- [JPEG Image Size \(still image\)](#)
- [RAW File Type \(still image\)](#)

Interchangeable Lens Digital Camera  
ILCE-7M3 α7III

## RAW File Type (still image)

---

Selects the file type for RAW images.

1 MENU →  1 (Camera Settings1) → [ RAW File Type] → desired setting.

### Menu item details



#### Compressed:

Records images in compressed RAW format.

#### Uncompressed:

Records images in uncompressed RAW format. When [Uncompressed] is selected for [ RAW File Type], the file size of the image will be larger than if it were recorded in compressed RAW format.

#### Note

- When [Uncompressed] is selected for [ RAW File Type], the icon on the screen switches to  .  is also displayed while an image shot in uncompressed RAW format is played back.

Interchangeable Lens Digital Camera  
ILCE-7M3 α7III

## APS-C/Super 35mm

Sets whether to record in APS-C-equivalent size for still images and in Super 35mm-equivalent size for movies. You can use an APS-C-size dedicated lens with this product by recording in an APS-C-equivalent size or Super 35 mm-equivalent size.

1 MENU →  1 (Camera Settings1) → [APS-C/Super 35mm] → desired setting.

### Menu item details

#### APS-C S35 Shooting:

Sets whether the camera automatically determines the capture range based on the lens. (Auto/Manual)

#### APS-C S35 Shoot.: Manual:

Sets whether to record in either an APS-C-equivalent size or Super 35mm-equivalent size when [ APS-C S35 Shooting] is set to [Manual]. (Off/On)

#### Note

- If you try to perform full-frame shooting with an APS-C-compatible lens attached, you may not achieve the desired shooting results.
- When APS-C/Super 35 mm shooting is activated, the central part of the image sensor is used and the angle of view is equivalent to that of an APS-C-size image sensor.

Interchangeable Lens Digital Camera  
ILCE-7M3 α7III

## Angle of view

The angle of view switches to the equivalent of full frame or APS-C/Super 35mm, depending on the setting for [APS-C/Super 35mm] and the attached lens. The angle of view is also different for still image shooting and movie shooting.

### Angle of view equivalent to full frame



(A) When shooting still images (with [Aspect Ratio] set to [3:2])

(B) When recording movies

The camera shoots with an angle of view equivalent to full frame in the following situations.

- [APS-C/S35 Shooting] under [APS-C/Super 35mm] is set to [Auto], and a full frame shooting-compatible lens is attached.
- [APS-C/S35 Shooting] under [APS-C/Super 35mm] is set to [Manual], and [APS-C/S35 Shoot.: Manual] is set to [Off].

### Angle of view equivalent to APS-C size/Super 35mm



(A) When shooting still images (with [Aspect Ratio] set to [3:2])

(B) When recording movies

The camera shoots with an angle of view equivalent to APS-C size or Super 35mm in the following situations. The angle of view becomes approx. 1.5 times the focal length indicated on the lens.

- [APS-C/S35 Shooting] under [APS-C/Super 35mm] is set to [Auto], and an APS-C-format dedicated lens is attached.
- [APS-C/S35 Shooting] under [APS-C/Super 35mm] is set to [Manual], and [APS-C/S35 Shoot.: Manual] is set to [On].

#### Note

- When recording full-frame movies with [File Format] set to [XAVC S 4K] and [Record Setting] set to [30p 60M] or [30p 100M], the angle of view (B) is equivalent to approx. 1.2 times the focal length indicated on the lens.



(A) Angle of view equivalent to full-frame

(B) Angle of view during XAVC S 4K movie recording set to [30p 60M]/[30p 100M]

(C) Angle of view equivalent to Super 35mm

---

### Related Topic

- [File Format \(movie\)](#)
- [Record Setting \(movie\)](#)
- [APS-C/Super 35mm](#)



Interchangeable Lens Digital Camera  
ILCE-7M3 α7III

## List of mode dial function

---

You can switch the shooting mode according to the subject or purpose of shooting.

- 1 Turn the mode dial to select the desired shooting mode.

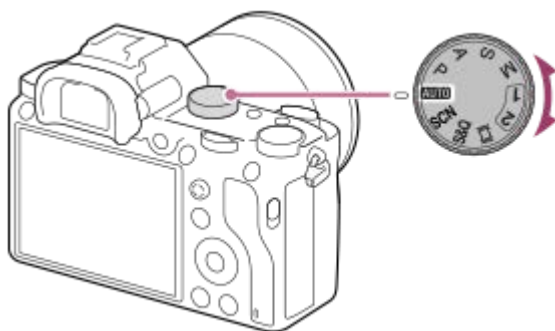

### Available functions

#### **i** (Intelligent Auto):

Allows you to shoot with automatic scene recognition.

#### **P** (Program Auto):

Allows you to shoot with the exposure adjusted automatically (both the shutter speed and the aperture value (F value)). Also you can select various settings using the menu.

#### **A** (Aperture Priority):

Allows you to adjust the aperture and shoot when you want to blur the background, etc.

#### **S** (Shutter Priority):

Allows you to shoot fast-moving subjects etc., by manually adjusting the shutter speed.

#### **M** (Manual Exposure):

Allows you to shoot still images with the desired exposure by adjusting the exposure (both the shutter speed and the aperture value (F value)).

#### **1/2**(Memory recall):

Allows you to shoot an image after recalling often-used modes or numeric settings registered in advance.

#### **Movie** (Movie):

Allows you to change the exposure mode for movie recording.

#### **S&Q** (S&Q Motion):

Allows you to shoot slow-motion and quick-motion movies.

#### **SCN** (Scene Selection):

Allows you to shoot with preset settings according to the scene.

---

### Related Topic

- [Intelligent Auto](#)
- [Program Auto](#)
- [Aperture Priority](#)
- [Shutter Priority](#)
- [Manual Exposure](#)
- [Recall \(Camera Settings1/Camera Settings2\)](#)
- [Movie: Exposure Mode](#)

- S&Q Motion: Exposure Mode
- Scene Selection

4-732-947-11(1) Copyright 2018 Sony Corporation

Interchangeable Lens Digital Camera  
ILCE-7M3 α7III

## Intelligent Auto

The camera shoots with automatic scene recognition.

### 1 Set the mode dial to **AUTO** (Auto Mode).

- The shooting mode will be set to **i** (Intelligent Auto).

### 2 Point the camera at the subject.

When the camera recognized the scene, the icon for the recognized scene appears on the screen.



### 3 Adjust the focus and shoot the image.

#### Note

- The product will not recognize the scene when you shoot images with zoom functions other than optical zoom.
- The product may not properly recognize the scene under certain shooting conditions.
- For [Intelligent Auto] mode, most of the functions are set automatically, and you cannot adjust the settings on your own.

#### Related Topic

- [About Scene Recognition](#)
- [Set. Face Prty in AF](#)
- [Face Prty in Mlti Mtr](#)

Interchangeable Lens Digital Camera  
ILCE-7M3 α7III

## About Scene Recognition











---

Scene Recognition operates in [Intelligent Auto] mode.

This function allows the product to automatically recognize the shooting conditions and shoot the image.

### Scene Recognition

When the product recognizes certain scenes, the following icons and guides are displayed on the first line:

-  (Portrait)
-  (Infant)
-  (Night Portrait)
-  (Night Scene)
-  (Backlight Portrait)
-  (Backlight)
-  (Landscape)
-  (Macro)
-  (Spotlight)
-  (Low Light)
-  (Night Scene using a tripod)

---

#### Related Topic

- [Intelligent Auto](#)

Interchangeable Lens Digital Camera  
ILCE-7M3 α7III

## Program Auto

---

Allows you to shoot with the exposure adjusted automatically (both the shutter speed and the aperture value).

You can set shooting functions such as [ISO].

- 1 **Set the mode dial to P (Program Auto).**
- 2 **Set the shooting functions to your desired settings.**
- 3 **Adjust the focus and shoot the subject.**

## Program Shift

When you are not using a flash, you can change the shutter speed and aperture (F-value) combination without changing the appropriate exposure set by the camera.

Turn the front/rear dial to select the aperture value and shutter speed combination.

- “P” on the screen changes to “P\*” when you turn the front/rear dial.
- To cancel program shift, set the shooting mode to other than [Program Auto], or turn off the camera.

### Note

- According to the brightness of the environment, the program shift may not be used.
- Set the shooting mode to another one than “P” or turn off the power to cancel the setting you made.
- When the brightness changes, the aperture (F-value) and shutter speed also change while maintaining the shift amount.

Interchangeable Lens Digital Camera  
ILCE-7M3 α7III

## Aperture Priority

---

You can shoot by adjusting the aperture and changing the range in focus, or by defocusing the background.

**1 Set the mode dial to A (Aperture Priority).**

**2 Select the desired value by turning the front/rear dial.**

- Smaller F-value: The subject is in focus, but objects in front of and beyond the subject are blurred.  
Larger F-value: The subject and its foreground and background are all in focus.
- If the aperture value you have set is not suitable for appropriate exposure, the shutter speed on the shooting screen will blink. If this happens, change the aperture value.

**3 Adjust the focus and shoot the subject.**

The shutter speed is automatically adjusted to obtain proper exposure.

**Note**

- The brightness of the image on the screen may differ from the actual image being shot.

---

**Related Topic**

- [Aperture Preview](#)

Interchangeable Lens Digital Camera  
ILCE-7M3 α7III

## Shutter Priority

You can express the movement of a moving subject in various ways by adjusting the shutter speed, for example, at the instant of the movement with high speed shutter, or as a trailing image with low speed shutter.

**1 Set the mode dial to S (Shutter Priority).**

**2 Select the desired value by turning the front/rear dial.**

- If proper exposure cannot be obtained after setup, the aperture value on the shooting screen blinks. If this happens, change the shutter speed.

**3 Adjust the focus and shoot the subject.**

The aperture is automatically adjusted to obtain proper exposure.

### Hint

- Use a tripod to prevent camera-shake when you have selected a slow shutter speed.
- When you shoot indoor sports scenes, set the ISO sensitivity to a higher value.

### Note

- The SteadyShot warning indicator does not appear in shutter speed priority mode.
- When [  Long Exposure NR ] is set to [On] and the shutter speed is 1 second(s) or longer, noise reduction will be done after shooting for the same amount of time that the shutter was open. However, you cannot shoot any more while noise reduction is in progress.
- The brightness of the image on the screen may differ from the actual image being shot.

### Related Topic

- [Long Exposure NR \(still image\)](#)

## Manual Exposure

You can shoot with the desired exposure setting by adjusting both the shutter speed and aperture.

### 1 Set the mode dial to M (Manual Exposure).

### 2 Select the desired aperture value by turning the front dial. Select the desired shutter speed by turning the rear dial.

- You can change the setting of the front/rear dial using MENU →  2 (Camera Settings2) → [Dial Setup].
- You can also set [ISO] to [ISO AUTO] in manual exposure mode. The ISO value automatically changes to achieve the appropriate exposure using the aperture value and shutter speed you have set.
- When [ISO] is set to [ISO AUTO], the ISO value indicator will blink if the value you have set is not suitable for appropriate exposure. If this happens, change the shutter speed or aperture value.
- When [ISO] is set to other than [ISO AUTO], use MM (Metered Manual)\* to check the exposure value.

**Toward +:** Images become brighter.

**Toward -:** Images become darker.

**0:** Appropriate exposure analyzed by the product.

\* Indicates under/over for appropriate exposure. It is displayed using a numerical value on the monitor and with a metering indicator on the viewfinder.

### 3 Adjust the focus and shoot the subject.

#### Hint

- You can change the shutter speed and aperture (F-value) combination without changing the set exposure value by rotating the front/rear dial while pressing the AEL button. (Manual shift)

#### Note

- The Metered Manual indicator does not appear when [ISO] is set to [ISO AUTO].
- When the amount of ambient light exceeds the metering range of the Metered Manual, the Metered Manual indicator flashes.
- The SteadyShot warning indicator does not appear in manual exposure mode.
- The brightness of the image on the screen may differ from the actual image being shot.



Interchangeable Lens Digital Camera  
ILCE-7M3 α7III

## Bulb shooting

You can shoot a trailing image of the movement of a subject with long exposure. Bulb shooting is suitable for shooting trails from stars or fireworks, etc.

- 1 **Set the mode dial to M (Manual Exposure).**
- 2 **Turn the rear dial clockwise until [BULB] is indicated.**
- 3 **Select the aperture value (F-value) using the front dial.**
- 4 **Press the shutter button halfway down to focus.**
- 5 **Press and hold the shutter button for the duration of the shooting.**

As long as the shutter button is pressed, the shutter remains open.

### Hint

- When shooting fireworks, etc., focus at infinity in manual focus mode. If you use a lens whose infinity point is unclear, adjust the focus on the fireworks in the area you want to focus on in advance.
- In order to perform bulb shooting without causing the image quality to deteriorate, we recommend that you start shooting while the camera is cool.
- Images shot in [BULB] mode tend to be blurry. We recommend that you use a tripod and a remote commander (sold separately) that has a shutter button lock function. Use a remote commander supporting connection via multi/micro USB jack.

### Note

- The longer the exposure time, the more noise will be visible on the image.
- After shooting, noise reduction will be done for the same amount of time that the shutter was open. However, you cannot shoot any more while noise reduction is in progress.
- You cannot set the shutter speed to [BULB] in the following situations:
  - [Auto HDR]
  - [Picture Effect] is set to [Rich-tone Mono.].
  - When [Drive Mode] is set to the following:
    - [Cont. Shooting]
    - [Self-timer(Cont)]
    - [Cont. Bracket]
  - [ Silent Shooting]

If you use the above functions when the shutter speed is set to [BULB], the shutter speed is temporarily set to 30 seconds.

### Related Topic

- [Manual Exposure](#)



Interchangeable Lens Digital Camera  
ILCE-7M3 α7III

## Scene Selection

---

Allows you to shoot with preset settings according to the scene.

- 1 Set the mode dial to SCN (Scene Selection).
- 2 Turn the front dial to select the desired setting.

### Menu item details

#### **Portrait:**

Blurs background and sharpens the subject. Accentuates the skin tones softly.



#### **Sports Action:**

Shoots a moving subject at a fast shutter speed so that the subject looks as if it is standing still. The product shoots images continuously while the shutter button is pressed.



#### **Macro:**

Shoots close-ups of the subjects, such as flowers, insects, food, or small items.



#### **Landscape:**

Shoots the entire range of a scenery in sharp focus with vivid colors.



#### **Sunset:**

Shoots the red of the sunset beautifully.



### Night Scene:

Shoots night scenes without losing the dark atmosphere.



### Night Portrait:

Shoots night scene portraits using the flash (sold separately).



#### Hint

- To change the scene, rotate the front dial on the shooting screen and select a new scene.

#### Note

- Under the following settings, the shutter speed is slower, so use of a tripod, etc. is recommended to prevent the image from blurring:
  - [Night Scene]
  - [Night Portrait]
- The minimum distance that you can come close to a subject does not change even if you select [Macro]. For the minimum in-focus range, refer to the minimum distance of the lens attached to the product.



---

#### Related Topic

- [Using flash \(sold separately\)](#)



Interchangeable Lens Digital Camera  
ILCE-7M3 α7III

## Recall (Camera Settings1/Camera Settings2)

Allows you to shoot an image after recalling often-used modes or camera settings registered with [**MR** 1/2 Memory] in advance.

**1** Set the mode dial to 1, 2 (Memory recall).



**2** Press the center of the control wheel to confirm.

- You can also recall registered modes or settings by selecting MENU → 1 (Camera Settings1) → [**MR** 1/2 Recall].

### Hint

- To recall settings registered to the memory card, set the mode dial to 1, 2 (Memory recall), then select the desired number by pressing the left/right side of the control wheel.
- If you recall settings registered to the memory card, the settings are recalled from the memory card in the slot specified in [**MR** Select Media]. You can confirm the memory card slot by selecting MENU → 1 (Camera Settings1) → [**MR** Select Media].
- Settings registered to a memory card using another camera of the same model name can be recalled with this camera.

### Note

- If you set [**MR** 1/2 Recall] after completing the shooting settings, the registered settings are given priority and the original settings may become invalid. Check the indicators on the screen before shooting.

### Related Topic



- [Memory \(Camera Settings1/Camera Settings2\)](#)

Interchangeable Lens Digital Camera  
ILCE-7M3 α7III

## Movie: Exposure Mode

---

You can set the exposure mode for movie shooting.

- 1 Set the mode dial to  (Movie).
- 2 MENU →  2 (Camera Settings2) → [ Exposure Mode] → desired setting.
- 3 Press the MOVIE (movie) button to start recording.
  - Press the MOVIE button again to stop recording.

### Menu item details

#### Program Auto:

Allows you to shoot with the exposure adjusted automatically (both the shutter speed and the aperture value).

#### Aperture Priority:

Allows you to shoot after adjusting the aperture value manually.

#### Shutter Priority:

Allows you to shoot after adjusting the shutter speed manually.

#### Manual Exposure:

Allows you to shoot after adjusting the exposure (both the shutter speed and the aperture value) manually.

Interchangeable Lens Digital Camera  
ILCE-7M3 α7III

## S&Q Motion: Exposure Mode

---

You can select the exposure mode for slow-motion/quick-motion shooting. You can change the setting and playback speed for slow-motion/quick-motion shooting with [**S&Q** S&Q Settings].

- 1 Set the mode dial to **S&Q** (S&Q Motion).
- 2 MENU →  2 (Camera Settings2) → [**S&Q** Exposure Mode] → desired setting.
- 3 Press the **MOVIE** (movie) button to start recording.
  - Press the **MOVIE** button again to stop recording.

### Menu item details

#### **S&Q** **P** Program Auto:

Allows you to shoot with the exposure adjusted automatically (both the shutter speed and the aperture value).

#### **S&Q** **A** Aperture Priority:

Allows you to shoot after adjusting the aperture value manually.

#### **S&Q** **S** Shutter Priority:

Allows you to shoot after adjusting the shutter speed manually.

#### **S&Q** **M** Manual Exposure:

Allows you to shoot after adjusting the exposure (both the shutter speed and the aperture value) manually.

---

### Related Topic

- [S&Q Settings](#)

Interchangeable Lens Digital Camera  
ILCE-7M3 α7III

## Exposure Comp.

Normally, exposure is set automatically (auto exposure). Based on the exposure value set by auto exposure, you can make the entire image brighter or darker if you adjust [Exposure Comp.] to the plus side or minus side, respectively (exposure compensation).

### 1 Turn the exposure compensation dial (A).

**+ (over) side:**

Images become brighter.

**- (under) side:**

Images become darker.

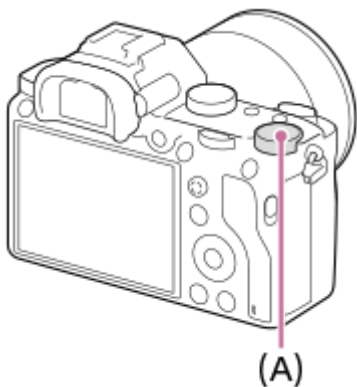

- You can adjust the exposure compensation value within the range of -3.0 EV to +3.0 EV.
- You can confirm the exposure compensation value that you set on the shooting screen.

#### Monitor

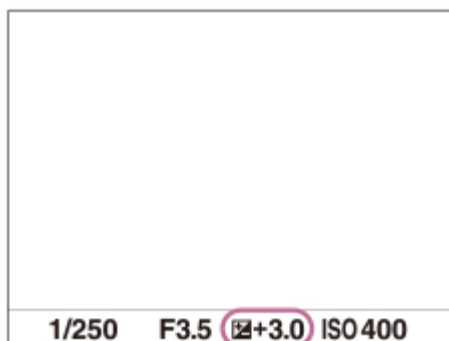

#### Viewfinder

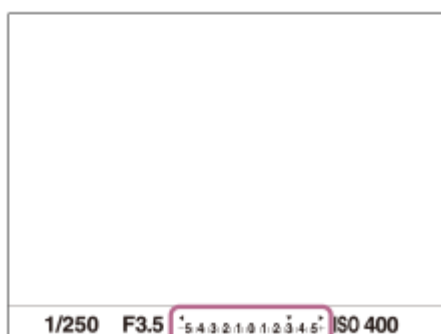



## To set the exposure compensation value using the MENU

You can adjust the exposure compensation value within a range of -5.0 EV to +5.0 EV when the exposure compensation dial is set to "0."

MENU →  1 (Camera Settings1) → [Exposure Comp.] → desired setting.

### Note

- You cannot perform the exposure compensation in the following shooting modes:
  - [Intelligent Auto]
  - [Scene Selection]
- When using [Manual Exposure], you can perform the exposure compensation only when [ISO] is set to [ISO AUTO].
- The settings of the exposure compensation dial will be prioritized over [Exposure Comp.] or [Dial Ev Comp] in MENU.
- Only a value between -3.0 EV and +3.0 EV with the equivalent image brightness appears on the screen when shooting. If you set an exposure compensation value outside this range, the image brightness on the screen will not be affected, but the value will be reflected in the recorded image.
- You can adjust the exposure compensation value within the range of -2.0 EV to +2.0 EV for movies.
- If you shoot a subject in extremely bright or dark conditions, or when you use the flash, you may not be able to get a satisfactory effect.
- When you set the exposure compensation dial to "0" from a setting other than "0," the exposure value switches to "0" regardless of the [Exposure Comp.] setting.

---

### Related Topic

- [Exposure step](#)
- [Dial Ev Comp](#)
- [Exp.comp.set](#)
- [Cont. Bracket](#)
- [Single Bracket](#)
- [Zebra Setting](#)

Interchangeable Lens Digital Camera  
ILCE-7M3 α7III

## Reset EV Comp.

---

Sets whether to maintain the exposure value set using [Exposure Comp.] when you turn off the power when the exposure compensation dial position is set to “0.”

**1** MENU →  1 (Camera Settings1) → [Reset EV Comp.] → desired setting.

### Menu item details

**Maintain:**

Maintains the settings.

**Reset:**

Resets the settings.

Interchangeable Lens Digital Camera  
ILCE-7M3 α7III

## Dial Ev Comp

---

You can adjust the exposure using the front dial or rear dial when the exposure compensation dial is set to "0." You can adjust the exposure in a range of -5.0 EV to +5.0 EV.

- 1 Set the exposure compensation dial to "0."
- 2 MENU →  2 (Camera Settings2) → [Dial Ev Comp] → desired setting.

### Menu item details

#### Off:

Does not enable exposure compensation with the front or rear dial.

#### Front dial/ Rear dial:

Enables exposure compensation with the front or rear dial.

#### Note

- When the exposure compensation function is assigned to the front or rear dial, any function that had been assigned to that dial previously is re-assigned to another dial.
- The settings of the exposure compensation dial will be prioritized over [Exposure Comp.] in MENU or the exposure settings using the front or rear dial.

---

### Related Topic

- [Exposure Comp.](#)

Interchangeable Lens Digital Camera  
ILCE-7M3 α7III

## Exposure Set. Guide

---

You can set whether to display a guide when you change the exposure.

**1** MENU →  2 (Camera Settings2) → [Exposure Set. Guide] → desired setting.

### Menu item details

**Off:**

Does not display the guide.

**On:**

Displays the guide.

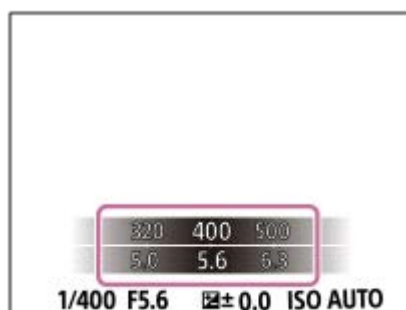

Interchangeable Lens Digital Camera  
ILCE-7M3 α7III

## Exposure step

---

You can adjust the setting increment for the shutter speed, aperture, and exposure compensation values.

1 MENU →  (Camera Settings1) → [Exposure step] → desired setting.

### Menu item details

0.3EV/0.5EV

#### Note

- Even if you set [Exposure step] to [0.5EV], the exposure value adjusted using the exposure compensation dial changes in steps of 0.3EV.

Interchangeable Lens Digital Camera  
ILCE-7M3 α7III

## Metering Mode

Selects the metering mode that sets which part of the screen to measure for determining the exposure.

1 MENU →  (Camera Settings1) → [Metering Mode] → desired setting.

### Menu item details

#### Multi:

Measures light on each area after dividing the total area into multiple areas and determines the proper exposure of the entire screen (Multi-pattern metering).

#### Center:

Measures the average brightness of the entire screen, while emphasizing the central area of the screen (Center-weighted metering).

#### Spot:

Measures only the central area (Spot metering). This mode is suitable for measuring light on a specified part of the entire screen. The size of the metering circle can be selected from [Spot: Standard] and [Spot: Large]. The position of the metering circle depends on the setting for [Spot Metering Point].

#### Entire Screen Avg.:

Measures the average brightness of the entire screen. The exposure will be stable even if the composition or the position of the subject changes.

#### Highlight:

Measures the brightness while emphasizing the highlighted area on the screen. This mode is suitable for shooting the subject while avoiding overexposure.

### Hint

- When [Spot] is selected and [Focus Area] is set to either [Flexible Spot] or [Expand Flexible Spot] while [Spot Metering Point] is set to [Focus Point Link], the spot metering point can be coordinated with the focus area.
- When [Multi] is selected and [Face Prty in Mlti Mtr] is set to [On], the camera measures brightness based on detected faces.
- When [Metering Mode] is set to [Highlight] and the [D-Range Opt.] or [Auto HDR] function is activated, the brightness and the contrast will be corrected automatically by dividing the image into small areas and analyzing the contrast of light and shadow. Make settings based on the shooting circumstances.

### Note

- [Metering Mode] is locked to [Multi] in the following shooting modes:
  - [Intelligent Auto]
  - [Scene Selection]
  - Other zoom functions than the optical zoom
- In [Highlight] mode, the subject may be dark if a brighter part exists on the screen.

### Related Topic

- [AE lock](#)
- [Spot Metering Point](#)
- [Face Prty in Mlti Mtr](#)
- [D-Range Opt. \(DRO\)](#)
- [Auto HDR](#)



Interchangeable Lens Digital Camera  
ILCE-7M3 α7III

## Face Prty in Mlti Mtr

---

Sets whether the camera measures brightness based on detected faces when [Metering Mode] is set to [Multi].

**1** MENU →  1 (Camera Settings1) → [Face Prty in Mlti Mtr] → desired setting.

### Menu item details

**On:**

The camera measures brightness based on detected faces.

**Off:**

The camera measures brightness using the [Multi] setting, without detecting faces.

**Note**

- When the shooting mode is set to [Intelligent Auto], [Face Prty in Mlti Mtr] is locked to [On].

---

### Related Topic

- [Metering Mode](#)



Interchangeable Lens Digital Camera  
ILCE-7M3 α7III

## Spot Metering Point

---

Sets whether to coordinate the spot metering position with the focus area when [Focus Area] is set to [Flexible Spot] or [Expand Flexible Spot].

1 MENU →  1 (Camera Settings1) → [Spot Metering Point] → desired setting.

### Menu item details

#### Center:

The spot metering position does not coordinate with the focus area, but always meters brightness at the center.

#### Focus Point Link:

The spot metering position coordinates with the focus area.

#### Note

- When [Focus Area] is set to other than [Flexible Spot] or [Expand Flexible Spot], the spot metering position is locked to the center.
- When [Focus Area] is set to [Lock-on AF: Flexible Spot] or [Lock-on AF:Expand Flexible Spot], the spot metering position coordinates to the Lock-on AF start position, but does not coordinate with the tracking of the subject.

---

### Related Topic

- [Focus Area](#)
- [Metering Mode](#)

Interchangeable Lens Digital Camera  
ILCE-7M3 α7III

## AE lock

When the contrast between the subject and background is high, such as when shooting a backlit subject or a subject near a window, meter the light at a spot where the subject appears to have the appropriate brightness and lock the exposure before shooting. To reduce the brightness of the subject, meter the light at a spot brighter than the subject and lock the exposure of the entire screen. To make the subject brighter, meter the light at a spot darker than the subject and lock the exposure of the entire screen.

**1 Adjust the focus on the spot at which the exposure is adjusted.**

**2 Press the AEL button.**

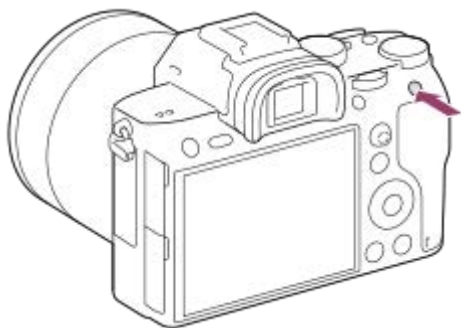

The exposure is locked, and **\*** (AE lock) is displayed.

**3 Keep pressing the AEL button and focus on the subject again, then shoot the picture.**

- Keep holding the AEL button down while taking a shot if you want to continue shooting with the fixed exposure. Release the button to reset the exposure.

### Hint

- If you select the MENU → 2 (Camera Settings2) → [ Custom Key] or [ Custom Key] → [AEL Button] → [AEL toggle], you can lock the exposure without holding down the button.



### Note

- [ AEL hold] and [ AEL toggle] are not available when using zoom functions other than optical zoom.

Interchangeable Lens Digital Camera  
ILCE-7M3 α7III

## AEL w/ shutter (still image)

Sets whether to fix the exposure when you press the shutter button halfway down.  
Select [Off] to adjust the focus and the exposure separately.

1 MENU →  (Camera Settings1) → [ AEL w/ shutter] → desired setting.

### Menu item details

#### Auto:

Fixes the exposure after adjusting the focus automatically when you press the shutter button halfway down when [Focus Mode] is set to [Single-shot AF]. When [Focus Mode] is set to [Automatic AF], and the product determines that the subject is moving, or you shoot burst images, the fixed exposure is cancelled.

#### On:

Fixes the exposure when you press the shutter button halfway down.

#### Off:

Does not fix the exposure when you press the shutter button halfway down. Use this mode when you want to adjust focus and exposure separately.

The product keeps adjusting the exposure while shooting in [Cont. Shooting] mode.

#### Note

- Operation using the AEL button is prioritized over the [ AEL w/ shutter] settings.

Interchangeable Lens Digital Camera  
ILCE-7M3 α7III

## Exposure Std. Adjust

Adjusts this camera's standard for the correct exposure value for each metering mode.

1 MENU →  1 (Camera Settings1) → [Exposure Std. Adjust] → desired metering mode.

2 Select the desired value as the metering standard.

- You can set a value from -1 EV to +1 EV in 1/6 EV increments.

## Metering Mode

The set standard value will be applied when you select the corresponding metering mode in MENU →  1 (Camera Settings1) → [Metering Mode].

 Multi/  Center/  Spot/  Entire Screen Avg./  Highlight

### Note

- The exposure compensation will not be affected when [Exposure Std. Adjust] is changed.
- The exposure value will be locked according to the value set for [  Spot] during using spot AEL.
- The standard value for M.M (Metered Manual) will be changed according to the value set in [Exposure Std. Adjust].
- The value set in [Exposure Std. Adjust] is recorded in Exif data separately from the exposure compensation value. The amount of exposure standard value will not be added to the exposure compensation value.
- If you set [Exposure Std. Adjust] during bracketing shooting, the number of shots for the bracketing will be reset.

## Related Topic

- [Metering Mode](#)

Interchangeable Lens Digital Camera  
ILCE-7M3 α7III

## Exp.comp.set

---

Sets whether to apply the exposure compensation value to control both flash light and ambient light, or just ambient light.

**1** MENU →  (Camera Settings1) → [Exp.comp.set] → desired setting.

### Menu item details

**Ambient&flash:**

Applies the exposure compensation value to control both flash light and ambient light.

**Ambient only:**

Applies the exposure compensation value to control ambient light only.

---

### Related Topic

- [Flash Comp.](#)

Interchangeable Lens Digital Camera  
ILCE-7M3 α7III

## Zebra Setting

Sets a zebra pattern, which appears over part of an image if the brightness level of that part meets the IRE level that you have set. Use this zebra pattern as a guide to adjust the brightness.

1 MENU →  2 (Camera Settings2) → [Zebra Setting] → desired setting.

### Menu item details

#### Zebra Display:

Sets whether to display the zebra pattern.

#### Zebra Level:

Adjusts the brightness level of the zebra pattern.

#### Hint

- You can register values to check the correct exposure or overexposure as well as the brightness level for [Zebra Level]. The settings for correct exposure confirmation and overexposure confirmation are registered to [Custom1] and [Custom2] respectively in the default settings.
- To check the correct exposure, set a standard value and the range for the brightness level. The zebra pattern will appear on areas that fall within the range you set.
- To check the overexposure, set a minimum value for the brightness level. The zebra pattern will appear over areas with a brightness level equal to or higher than the value you set.

#### Note

- The zebra pattern is not displayed on devices connected via HDMI.

Interchangeable Lens Digital Camera  
ILCE-7M3 α7III

## D-Range Opt. (DRO)

By dividing the image into small areas, the product analyzes the contrast of light and shadow between the subject and the background, and creates an image with the optimal brightness and gradation.

- 1 MENU →  1 (Camera Settings1) → [DRO/Auto HDR] → [D-Range Opt.].
- 2 Select the desired setting using the left/right sides of the control wheel.

### Menu item details

#### D-Range Optimizer: Auto:

Corrects the brightness automatically.

#### D-Range Optimizer: Lv1 — D-Range Optimizer: Lv5:

Optimizes the gradation of a recorded image for each divided area. Select the optimization level from Lv1 (weak) to Lv5 (strong).

#### Note

- In the following situations, [D-Range Opt.] is fixed to [Off]:
  - When [Picture Effect] is set to other than [Off]
  - When [Picture Profile] is set to other than [Off]
- [DRO/Auto HDR] is fixed to [Off] when the following modes are selected in [Scene Selection].
  - [Sunset]
  - [Night Scene]
  - [Night Portrait]

The setting is fixed to [D-Range Optimizer: Auto] when [Scene Selection] modes other than the above modes are selected.

- When shooting with [D-Range Opt.], the image may be noisy. Select the proper level by checking the recorded image, especially when you enhance the effect.

Interchangeable Lens Digital Camera  
ILCE-7M3 α7III

## Auto HDR

Shoots three images using different exposures and combines the images with correct exposure, the bright parts of an underexposed image, and the dark parts of an overexposed image to create images with a greater range of gradation (High Dynamic Range). One image with proper exposure and one overlaid image are recorded.

1 MENU →  1 (Camera Settings1) → [DRO/Auto HDR] → [Auto HDR].

2 Select the desired setting using the left/right sides of the control wheel.

### Menu item details

 **Auto HDR: Exposure Diff. Auto:**

Corrects the brightness automatically.

 **Auto HDR: Exposure Diff. 1.0EV — Auto HDR: Exposure Diff. 6.0EV:**



Sets the exposure difference, based on the contrast of the subject. Select the optimization level from 1.0EV (weak) to 6.0EV (strong).

For example, if you set the exposure value to 2.0 EV, three images will be composed with the following exposure levels: -1.0 EV, correct exposure and +1.0 EV.

#### Hint

- The shutter is released three times for one shot. Be careful about the following:
  - Use this function when the subject is motionless or does not flash light.
  - Do not change the composition before shooting.

#### Note

- This function is not available when the [ File Format] is [RAW] or [RAW & JPEG].
- [Auto HDR] is not available in the following shooting modes:
  - [Intelligent Auto]
  - [Scene Selection]
- [Auto HDR] is not available in the following situations:
  - When [Picture Effect] is set to other than [Off].
  - When [Picture Profile] is set to other than [Off].
- You cannot start the next shot until the capture process is completed after you shoot.
- You may not obtain the desired effect depending on the luminance difference of a subject and the shooting conditions.
- When the flash is used, this function has little effect.
- When the contrast of the scene is low or when product shake or subject blur occurs, you may not obtain good HDR images.   will be displayed over the recorded image to inform you when the camera detects image blurring. Change the composition or re-shoot the image carefully to avoid image blur, as needed.



Interchangeable Lens Digital Camera  
ILCE-7M3 α7III

## ISO

Sensitivity to light is expressed by the ISO number (recommended exposure index). The larger the number, the higher the sensitivity.

### 1 ISO (ISO) on the control wheel → select desired setting.

- You can also select MENU →  1 (Camera Settings1) → [ISO].
- You can change the value by 1/3 EV steps by turning the front dial as well as by turning the control wheel. You can change the value by 1 EV steps by turning the rear dial.

### Menu item details

#### ISO AUTO:

Sets the ISO sensitivity automatically.

#### ISO 50 – ISO 204800:

Sets the ISO sensitivity manually. Selecting a larger number increases the ISO sensitivity.

#### Hint

- You can change the range of ISO sensitivity that is set automatically in [ISO AUTO] mode. Select [ISO AUTO] and press the right side of the control wheel, and set the desired values for [ISO AUTO Maximum] and [ISO AUTO Minimum].

#### Note

- [ISO AUTO] is selected when using the following functions:
  - [Intelligent Auto]
  - [Scene Selection]
- When the ISO sensitivity is set to a value lower than ISO 100, the range for recordable subject brightness (dynamic range) may decrease.
- The higher the ISO value, the more noise will appear on the images.
- The available ISO settings will differ depending on whether you are shooting still images, shooting movies, or shooting slow-motion/quick-motion movies.
- When shooting movies, ISO values between 100 and 102400 are available. If the ISO value is set to a value larger than 102400, the setting is automatically switched to 102400. When you finish recording the movie, the ISO value returns to the original setting.
- When shooting movies, ISO values between 100 and 102400 are available. If the ISO value is set to a value smaller than 100, the setting is automatically switched to 100. When you finish recording the movie, the ISO value returns to the original setting.
- When you select [ISO AUTO] with the shooting mode set to [P], [A], [S] or [M], the ISO sensitivity will be automatically adjusted within the set range.

Interchangeable Lens Digital Camera  
ILCE-7M3 α7III

## ISO AUTO Min. SS

If you select [ISO AUTO] when the shooting mode is P (Program Auto) or A (Aperture Priority), you can set the shutter speed at which the ISO sensitivity starts changing.

This function is effective for shooting moving subjects. You can minimize subject blurring while also preventing camera shake.

1 MENU →  1 (Camera Settings1) → [ISO AUTO Min. SS] → desired setting.

### Menu item details

#### **FASTER (Faster)/FAST (Fast):**

The ISO sensitivity will start to change at shutter speeds faster than [Standard], so you can prevent camera shake and subject blurring.

#### **STD (Standard):**

The camera automatically sets the shutter speed based on the focal length of the lens.

#### **SLOW (Slow)/SLOWER (Slower):**

The ISO sensitivity will start to change at shutter speeds slower than [Standard], so you can shoot images with less noise.

#### **1/8000 — 30":**

The ISO sensitivity starts to change at the shutter speed you have set.

#### Hint

- The difference in shutter speed at which ISO sensitivity starts to change between [Faster], [Fast], [Standard], [Slow], and [Slower] is 1 EV.

#### Note

- If the exposure is insufficient even when the ISO sensitivity is set to [ISO AUTO Maximum] in [ISO AUTO], in order to shoot with an appropriate exposure, the shutter speed will be slower than the speed set in [ISO AUTO Min. SS].
- In the following situations, the shutter speed may not function as set:
  - When using the flash to shoot bright scenes. (The maximum shutter speed is limited to the flash-syncing speed of 1/250 second.)
  - When using the flash to shoot dark scenes with the [Flash Mode] set to [Fill-flash]. (The minimum shutter speed is limited to the speed automatically determined by the camera.)

### Related Topic

- [Program Auto](#)
- [Aperture Priority](#)
- [ISO](#)

Interchangeable Lens Digital Camera  
ILCE-7M3 α7III

## The zoom features available with this product

The zoom feature of the product provides a higher magnification zoom by combining various zoom features. The icon displayed on the screen changes, according to the selected zoom feature.

When a power zoom lens is mounted:

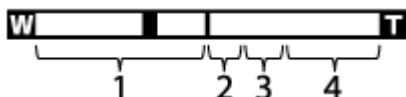

When a lens other than a power zoom lens is mounted:

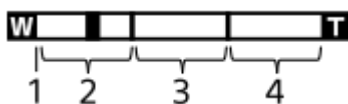

### 1. Optical zoom range

Zoom images in the zoom range of a lens.

When a power zoom lens is mounted, the zoom bar of the optical zoom range is displayed.

When a lens other than a power zoom lens is mounted, the zoom slider is fixed at the left end of the zoom bar while the zoom position is in the optical zoom range (displayed as  $\times 1.0$ ).

### 2. Smart Zoom range ( )

Zoom images without causing the original quality to deteriorate by partially cropping an image (only when [  JPEG Image Size] is set to [M] or [S]).





### 3. Clear Image Zoom range ( )

Zoom images using an image process with less deterioration. When you set [Zoom Setting] to [On:ClearImage Zoom] or [On:Digital Zoom], you can use this zoom function.

### 4. Digital Zoom range ( )

You can magnify images using an image process. When you set [Zoom Setting] to [On:Digital Zoom], you can use this zoom function.

#### Note

- The default setting for the [Zoom Setting] is [Optical zoom only].
- The default setting for the [  JPEG Image Size] is [L]. To use the smart zoom, change [  JPEG Image Size] to [M] or [S].
- Zoom functions other than the optical zoom are not available when shooting in the following situations:
  - [  File Format] is set to [RAW] or [RAW & JPEG].
  - [  Record Setting] is set to [120p]/[100p].
  - During slow-motion/quick-motion shooting with the [  Frame Rate] set to [120fps]/[100fps]
- You cannot use the Smart Zoom function with movies.
- When a power zoom lens is mounted, you cannot use [Zoom] under MENU. If you enlarge image past the optical zoom range, the product automatically switches to another [Zoom] function than the optical zoom.
- When you use a zoom function other than the optical zoom, [Metering Mode] is fixed to [Multi].
- When using a zoom function other than the optical zoom, the following functions are not available:
  - Face Priority in AF
  - Face Prty in Mlti Mtr
  - Lock-on AF

- To use another zoom function than the optical zoom for movies, assign [Zoom] to the desired key using [ Custom Key].

---

### Related Topic

- [Clear Image Zoom/Digital Zoom \(Zoom\)](#)
- [Zoom Setting](#)
- [About zoom scale](#)



4-732-947-11(1) Copyright 2018 Sony Corporation

Interchangeable Lens Digital Camera  
ILCE-7M3 α7III



## Clear Image Zoom/Digital Zoom (Zoom)

---

When you use a zoom function other than the optical zoom, you can exceed the zoom range of the optical zoom.

- 1 MENU →  (Camera Settings2) → [Zoom Setting] → [On:ClearImage Zoom] or [On:Digital Zoom].
- 2 When a power zoom lens is mounted, move the zoom lever or the zoom ring of the zoom lens to enlarge subjects.
  - When you exceed the zoom range of the optical zoom, the camera automatically switches to another zoom than the optical zoom.
- 3 When a lens other than a power zoom lens is mounted, select MENU →  (Camera Settings2) → [Zoom] → desired value.

Press the center of the control wheel to exit.

  - You can also assign the [Zoom] function to the desired button by selecting MENU →  (Camera Settings2) → [ Custom Key] or [ Custom Key].

---

### Related Topic

- [Zoom Setting](#)
- [The zoom features available with this product](#)
- [Custom Key \(still image/movie/playback\)](#)

Interchangeable Lens Digital Camera  
ILCE-7M3 α7III

## Zoom Setting

---

You can select the zoom setting of the product.

**1** MENU →  2 (Camera Settings2) → [Zoom Setting] → desired setting.

### Menu item details

#### Optical zoom only:

Limits the zoom range to the optical zoom. You can use the Smart Zoom function if you set [  JPEG Image Size] to [M] or [S].

#### On:ClearImage Zoom:

Select this setting to use Clear Image Zoom. Even if the zoom range exceeds the optical zoom, the product magnifies images within the range in which image quality does not deteriorate significantly.

#### On:Digital Zoom:

When the zoom range of the Clear Image Zoom is exceeded, the product magnifies images to the largest scale. However, the image quality will deteriorate.

#### Note

- Set [Optical zoom only] if you want to magnify images within the range in which image quality does not deteriorate.

---

### Related Topic

- [The zoom features available with this product](#)
- [About zoom scale](#)

## About zoom scale

The zoom scale that is used in combination with the zoom of the lens changes according to the selected image size.

When [ Aspect Ratio] is [3:2]

Zoom Setting	 JPEG Image Size	Full-frame/APS-C	Zoom scale
Optical zoom only (including smart zoom)	L	-	-
	M	Full-frame	Approx. 1.5×
		APS-C	Approx. 1.3×
	S	Full-frame	Approx. 2×
		APS-C	Approx. 2×
	On:ClearImage Zoom	L	Full-frame
APS-C			Approx. 2×
M		Full-frame	Approx. 3×
		APS-C	Approx. 2.6×
S		Full-frame	Approx. 4×
		APS-C	Approx. 4×
On:Digital Zoom	L	Full-frame	Approx. 4×
		APS-C	Approx. 4×
	M	Full-frame	Approx. 6.1×
		APS-C	Approx. 5.2×
	S	Full-frame	Approx. 8×
		APS-C	Approx. 8×

### Related Topic

- [Clear Image Zoom/Digital Zoom \(Zoom\)](#)
- [The zoom features available with this product](#)
- [Zoom Setting](#)
- [JPEG Image Size \(still image\)](#)

Interchangeable Lens Digital Camera  
ILCE-7M3 α7III

## Zoom Ring Rotate

---

Assigns zoom in (T) or zoom out (W) functions to the zoom ring rotation direction. Available only with power zoom lenses that support this function.

**1** MENU →  2 (Camera Settings2) → [Zoom Ring Rotate] → desired setting.

### Menu item details

#### Left(W)/Right(T):

Assigns zoom out (W) function to left-handed rotation and zoom-in (T) function to right-handed rotation.

#### Right(W)/Left(T):

Assigns zoom in (T) function to left-handed rotation and zoom-out (W) function to right-handed rotation.















Interchangeable Lens Digital Camera  
ILCE-7M3 α7III

## White Balance

Corrects the tone effect of the ambient light condition to record a neutral white subject in white. Use this function when the color tones of the image did not come out as you expected, or when you want to change the color tones on purpose for photographic expression.

1 MENU →  1 (Camera Settings1) → [White Balance] → desired setting.

### Menu item details

   Auto/  Daylight/  Shade/  Cloudy/  Incandescent/  -1 Fluor.: Warm White/  0 Fluor.: Cool White/  +1 Fluor.: Day White/  +2 Fluor.: Daylight/  Flash/  Underwater Auto: When you select a light source that illuminates the subject, the product adjusts the color tones to suit to the selected light source (preset white balance). When you select [Auto], the product automatically detects the light source and adjusts the color tones.

#### C.Temp./Filter:

Adjusts the color tones depending on the light source. Achieves the effect of CC (Color Compensation) filters for photography.

#### Custom 1/Custom 2/Custom 3:



Uses the white balance setting saved in [Custom Setup].

#### SET Custom Setup:

Memorizes the basic white color under the light conditions for the shooting environment.

Select a memorized custom white balance number.

### Hint

- You can display the fine adjustment screen and perform fine adjustments of the color tones as required by pressing the right side of the control wheel.
- If the color tones do not come out as you expected in the selected settings, perform [WB bracket] shooting.
-  or  is displayed only when [Priority Set in AWB] is set to [Ambience] or [White].

### Note

- [White Balance] is fixed to [Auto] in the following shooting modes:
  - [Intelligent Auto]
  - [Scene Selection]
- If you use a mercury lamp or a sodium lamp as a light source, the accurate white balance will not be obtained because of the characteristics of the light. It is recommended to shoot images using a flash or select [Custom Setup].

### Related Topic

- [Capturing a basic white color in \[Custom Setup\] mode](#)
- [Priority Set in AWB](#)
- [WB bracket](#)

Interchangeable Lens Digital Camera  
ILCE-7M3 α7III

## Priority Set in AWB

---

Selects which tone to prioritize when shooting under lighting conditions such as incandescent light when [White Balance] is set to [Auto].

1 MENU →  1 (Camera Settings1) → [Priority Set in AWB] → desired setting.

### Menu item details

AWB  
STD **Standard:**

Shoots with standard auto white balance. The camera automatically adjusts the color tones.

AWB  
Ambi **Ambience:**

Prioritizes the color tone of the light source. This is suitable when you want to produce a warm atmosphere.

AWB  
White **White:**

Prioritizes a reproduction of white color when the color temperature of the light source is low.

---

### Related Topic

- [White Balance](#)

## Capturing a basic white color in [Custom Setup] mode

In a scene where the ambient light consists of multiple types of light sources, it is recommended to use the custom white balance in order to accurately reproduce the whiteness. You can register 3 settings.

**1** MENU →  1 (Camera Settings1) → [White Balance] → [Custom Setup].

**2** Hold the product so that the white area fully covers the circle located in the center of the screen, and then press the center of the control wheel.

After the shutter sound beeps, the calibrated values (Color Temperature and Color Filter) are displayed.

**3** Select a registration number using the left/right sides of the control wheel, and then press the center.

The monitor returns to the recording information display while retaining the memorized custom white balance setting.

- The registered custom white balance setting will remain memorized until overwritten by the another setting.

### Note

- The message [Custom WB Error] indicates that the value is in the unexpected range, for example when the subject is too vivid. You can register the setting at this point, but it is recommended that you set the white balance again. When an error value is set, the indicator  turns orange on the recording information display. The indicator will be displayed in white when the set value is in the expected range.
- If you use a flash when capturing a shot, the custom white balance will be registered with the flash light. Shoot images with a flash when recalling a setting registered with the flash.

## Creative Style

Allows you to set the desired image processing and finely adjust contrast, saturation and sharpness for each image style. You can adjust exposure (shutter speed and aperture) as you like with this function, unlike with [Scene Selection], where the product adjusts the exposure.

- 1 **MENU** → 1 (Camera Settings1) → [Creative Style].
- 2 Select the desired style or [Style Box] using the top/bottom sides of the control wheel.
- 3 To adjust (Contrast), (Saturation) and (Sharpness), select the desired item using the right/left sides, and then select the value using the top/bottom sides.

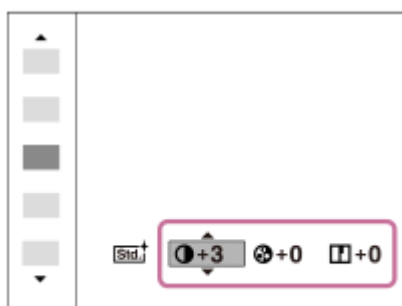

- 4 When selecting [Style Box], move to the right side using the right side of the control wheel, and then select the desired style.

- You can call up the same style with slightly different settings.

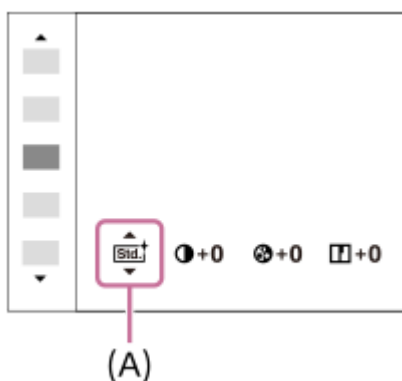

(A): Displayed only when Style Box is selected

### Menu item details

#### Standard:

For shooting various scenes with rich gradation and beautiful colors.

#### Vivid:

The saturation and contrast are heightened for shooting striking images of colorful scenes and subjects such as flowers, spring greenery, blue sky, or ocean views.

#### Neutral:

The saturation and sharpness are lowered for shooting images in subdued tones. This is also suitable for capturing image material to be modified with a computer.

 **Clear:**

For shooting images in clear tones with limpid colors in highlight, suitable for capturing radiant light.

 **Deep:**

For shooting images with deep and dense colors, suitable for capturing the solid presence of the subject.

 **Light:**

For shooting images with bright and simple colors, suitable for capturing a refreshingly light ambience.

 **Portrait:**

For capturing skin in a soft tone, ideally suited for shooting portraits.

 **Landscape:**

The saturation, contrast, and sharpness are heightened for shooting vivid and crisp scenery. Distant landscapes also stand out more.

 **Sunset:**

For shooting the beautiful red of the setting sun.

 **Night Scene:**

The contrast is lowered for reproducing night scenes.

 **Autumn leaves:**

For shooting autumn scenes, vividly highlighting the reds and yellows of changing leaves.

 **Black & White:**

For shooting images in black and white monotone.

 **Sepia:**

For shooting images in sepia monotone.

 **Registering preferred settings (Style Box):**

Select the six style box (the boxes with numbers on the left side (  )) to register preferred settings. Then select the desired settings using the right button.

You can call up the same style with slightly different settings.

## To set [Contrast], [Saturation] and [Sharpness]

[Contrast], [Saturation], and [Sharpness] can be adjusted for each image style preset such as [Standard] and [Landscape], and for each [Style Box] to which you can register preferred settings.

Select an item to be set by pressing the right/left sides of the control wheel, then set the value using the top/bottom sides of the control wheel.

 **Contrast:**

The higher the value selected, the more the difference of light and shadow is accentuated, and the bigger the effect on the image.

 **Saturation:**

The higher the value selected, the more vivid the color. When a lower value is selected, the color of the image is restrained and subdued.

 **Sharpness:**

Adjusts the sharpness. The higher the value selected, the more the contours are accentuated, and the lower the value selected, the more the contours are softened.

### Note

- [Creative Style] is fixed to [Standard] in the following situations:
  - [Intelligent Auto]
  - [Scene Selection]
  - [Picture Effect] is set to other than [Off].
  - [Picture Profile] is set to other than [Off].
- When this function is set to [Black & White] or [Sepia], [Saturation] cannot be adjusted.

Interchangeable Lens Digital Camera  
ILCE-7M3 α7III

## Picture Effect

Select the desired effect filter to achieve more impressive and artistic images.

1 MENU →  (Camera Settings1) → [Picture Effect] → desired setting.

### Menu item details

 **Off:**

Disables the [Picture Effect] function.

 **Toy Camera:**

Creates a soft image with shaded corners and reduced sharpness.

 **Pop Color:**

Creates a vivid look by emphasizing color tones.

 **Posterization:**

Creates a high contrast, abstract look by heavily emphasizing primary colors, or in black and white.

 **Retro Photo:**

Creates the look of an aged photo with sepia color tones and faded contrast.

 **Soft High-key:**

Creates an image with the indicated atmosphere: bright, transparent, ethereal, tender, soft.

 **Partial Color:**

Creates an image which retains a specific color, but converts others to black and white.

 **High Contrast Mono.:**

Creates a high-contrast image in black and white.

 **Rich-tone Mono.:**

Creates an image in black and white with rich gradation and reproduction of details.

### Hint

- You can perform detailed settings for some items using the left/right sides of the control wheel.

### Note

- When you use a zoom function other than the optical zoom, setting the zoom scale larger makes [Toy Camera] less effective.
- When [Partial Color] is selected, images may not retain the selected color, depending on the subject or shooting conditions.
- You cannot check the following effects on the shooting screen, because the product processes the image after the shot. Also, you cannot shoot another image until image processing is finished. You cannot use these effects with movies.
  - [Rich-tone Mono.]
- In the case of [Rich-tone Mono.], the shutter is released three times for one shot. Be careful about the following:
  - Use this function when the subject is motionless or does not flash light.
  - Do not change the composition during shooting.

When the contrast of the scene is low or when significant camera-shake or subject blur has occurred, you may not be able to obtain good HDR images. If the product detects such a situation,  appear on the recorded image to inform you of this situation. Change the composition or re-shoot the image carefully to avoid image blur, as needed.



- This function is not available in the following shooting modes:
  - [Intelligent Auto]
  - [Scene Selection]
- When [ File Format] is set to [RAW] or [RAW & JPEG], this function is not available.



Interchangeable Lens Digital Camera  
ILCE-7M3 α7III

## Color Space (still image)

The way colors are represented using combinations of numbers or the range of color reproduction is called “color space.” You can change the color space depending on the purpose of the image.

1 MENU →  (Camera Settings1) → [ Color Space] → desired setting.

### Menu item details

#### sRGB:

This is the standard color space of the digital camera. Use [sRGB] in normal shooting, such as when you intend to print out the images without any modification.

#### AdobeRGB:

This color space has a wide range of color reproduction. When a large part of the subject is vivid green or red, Adobe RGB is effective. The file name of the recorded image starts with “\_.”

#### Note

- [AdobeRGB] is for applications or printers that support color management and DCF2.0 option color space. Images may not be printed or viewed in the correct colors if you use applications or printers that do not support Adobe RGB.
- When displaying images that were recorded with [AdobeRGB] on non-Adobe RGB-compliant devices, the images will be displayed with low saturation.





Interchangeable Lens Digital Camera  
ILCE-7M3 α7III

## Anti-flicker Shoot. (still image)

Detects flickering/blinking from artificial light sources such as fluorescent lighting and times the shooting of images to moments when flickering will have less of an impact.

This function reduces differences in the exposure and color tone caused by flickering between the upper area and the lower area of an image shot with fast shutter speed and during continuous shooting.

- 1 MENU →  1 (Camera Settings1) → [ Anti-flicker Shoot.] → [On].
- 2 Press the shutter button halfway down, and then shoot the image.
  - The product detects flickering when the shutter button is pressed halfway down.



### Menu item details

- Off:**  
Does not reduce influences caused by flickering.
- On:**  
Reduces influences caused by flickering. When the camera detects flickering while the shutter button is pressed halfway down, **Flicker** (flicker icon) will be displayed.

#### Hint

- The color tone of the shot result may vary when you shoot the same scene using a different shutter speed. If that happens, we recommend that you shoot in [Shutter Priority] or [Manual Exposure] mode with a fixed shutter speed.
- You can perform anti-flicker shooting by pressing the shutter button halfway down even when in manual focus mode.

#### Note

- The shutter release lag may increase slightly. In continuous shooting mode, the shooting speed may slow down or the interval between each shot may become unequal.
- The camera detects flickering when the frequency of the light source is 100 Hz or 120 Hz only.
- The camera cannot detect flickering depending on the light source and shooting conditions, such as a dark background.
- Even if the camera detects flickering, the influences caused by flickering may not be reduced enough depending on the light source or the shooting situation. We recommend that you take test shots beforehand.
- [ Anti-flicker Shoot.] is not available when shooting in the following situations:
  - While bulb shooting
  - [ Silent Shooting]
  - Movie shooting mode
  - When shooting an image without pressing the shutter button halfway down in manual focus mode
- The color tone of the shot results may differ depending on the setting of [ Anti-flicker Shoot.].

Interchangeable Lens Digital Camera  
ILCE-7M3 α7III

## Release w/o Lens

---

Sets whether or not the shutter can be released when no lens is attached.

**1** MENU →  2 (Camera Settings2) → [Release w/o Lens] → desired setting.

### Menu item details

**Enable:**

Releases the shutter when no lens is attached. Select [Enable] when attaching the product to an astronomical telescope, etc.

**Disable:**

Does not release the shutter when a lens is not attached.

**Note**

- Correct metering cannot be achieved when you use lenses that do not provide a lens contact, such as the lens of an astronomical telescope. In such cases, adjust the exposure manually by checking it on the recorded image.

Interchangeable Lens Digital Camera  
ILCE-7M3 α7III

## Release w/o Card

---

Sets whether the shutter can be released when no memory card has been inserted.

**1** MENU →  2 (Camera Settings2) → [Release w/o Card] → desired setting.

### Menu item details

**Enable:**

Releases the shutter even if no memory card has been inserted.

**Disable:**

Does not release the shutter when no memory card has been inserted.



**Note**

- When no memory card has been inserted, the images shot will not be saved.
- The default setting is [Enable]. It is recommended that you select [Disable] prior to actual shooting.

Interchangeable Lens Digital Camera  
ILCE-7M3 α7III

## Silent Shooting (still image)

You can shoot images without the shutter sound.

1 MENU →  2 (Camera Settings2) → [ Silent Shooting] → desired setting.

### Menu item details













#### On:

You can shoot images without the shutter sound.

#### Off:

[ Silent Shooting] is deactivated.

#### Note

- Use the [ Silent Shooting] function on your own responsibility, while taking sufficient consideration to the privacy and portrait rights of the subject.
- Even if [ Silent Shooting] is set to [On], it will not be completely silent.
- Even if [ Silent Shooting] is set to [On], the operating sound of the aperture and focus will sound.
- When shooting still images using the [ Silent Shooting] function with low ISO sensitivity, if you point the camera at a very bright light source, high intensity areas on the monitor may be recorded in darker tones.
- When the power is turned off, the shutter sound may beep in rare occasions. This is not a malfunction.
- Image distortion caused by the movement of the subject or the camera may occur. The distortion may become more noticeable when [ RAW File Type] is set to [Uncompressed]. To decrease the distortion, set [ File Format] to [JPEG]. If you want to shoot images in the RAW format with less distortion, set [Drive Mode] to [Cont. Shooting] and [ RAW File Type] to [Compressed].
- If you shoot images under instantaneous lightning or flickering lights, such as the flash light from other cameras or fluorescent lighting, a striping effect may occur on the image.
- If you want to turn off the beep that sounds when the subject is in focus or the self-timer operates, set [Audio signals] to [Off].
- Even if [ Silent Shooting] is set to [On], the shutter sound may beep under the following circumstances:
  - When you capture a basic white color while the camera is set to the [Custom Setup] mode under [White Balance]
  - When you register faces using [Face Registration]
- You cannot select [ Silent Shooting] when the mode dial is set to other than P/A/S/M.
- When [ Silent Shooting] is set to [On], the following functions are not available:
  - Flash shooting
  - Auto HDR
  - Picture Effect
  - Picture Profile
  -  Long Exposure NR
  - e-Front Curtain Shut.
  - BULB shooting
- After you turn the camera on, the time in which you can start recording is extended by approximately 0.5 seconds.
- Bracket shooting is unavailable during silent shooting when [ File Format] is set to [RAW] or [RAW & JPEG] and [ RAW File Type] is set to [Uncompressed].



Interchangeable Lens Digital Camera  
ILCE-7M3 α7III

## e-Front Curtain Shut.

The electronic front curtain shutter function shortens the time lag between when the shutter button is pressed and the shutter is released.

1 MENU →  2 (Camera Settings2) → [e-Front Curtain Shut.] → desired setting.

### Menu item details

#### On:

Uses the electronic front curtain shutter function.

#### Off:

Does not use the electronic front curtain shutter function.

#### Note

- When you shoot at high shutter speeds with a large-aperture lens attached, out-of-focus circle produced by the bokeh effect may get cut off because of the shutter mechanism. If this happens, set [e-Front Curtain Shut.] to [Off].
- When a lens made by another manufacturer (including a Minolta/Konica-Minolta lens) is used, set this function to [Off]. If you set this function to [On], the correct exposure will not be set or the image brightness will be uneven.
- When you shoot at high shutter speeds, the image brightness may become uneven depending on the shooting environment. In such cases, set [e-Front Curtain Shut.] to [Off].

Interchangeable Lens Digital Camera  
ILCE-7M3 α7III

## SteadyShot

---

Sets whether or not to use the SteadyShot function.

**1** MENU →  **2** (Camera Settings2) → [SteadyShot] → desired setting.

### Menu item details

**On:**

Uses [SteadyShot].

**Off:**

Does not use [SteadyShot].

We recommend that you set [Off] when using a tripod, etc.

Interchangeable Lens Digital Camera  
ILCE-7M3 α7III

## SteadyShot Settings

You can shoot with an appropriate SteadyShot setting for the attached lens.

- 1 MENU →  2 (Camera Settings2) → [SteadyShot] → [On].
- 2 [SteadyShot Settings] → [SteadyShot Adjust.] → desired setting.

### Menu item details

#### Auto:

Performs the SteadyShot function automatically according to the information obtained from the attached lens.



#### Manual:

Performs the SteadyShot function according to the focal-length set using [SteadyS. Focal Len.]. (8mm-1000mm)

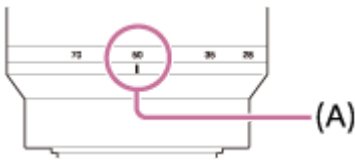
- Check the focal-length index (A) and set the focal-length.



### Note

- The SteadyShot function may not work optimally when the power has just been turned on, right after you point the camera towards a subject, or when the shutter button has been pressed all the way down without stopping halfway.
- When using a tripod, etc., make sure to turn off the SteadyShot function because this can cause any malfunction when shooting.
- [SteadyShot Settings] will be unavailable when MENU →  2 (Camera Settings2) → [SteadyShot] is set to [Off].
- When the camera cannot obtain focal length information from the lens, the SteadyShot function does not work correctly. Set [SteadyShot Adjust.] to [Manual] and set [SteadyS. Focal Len.] to match the lens you are using. The current set value of the SteadyShot focal length will display to the side of .
- When using an SEL16F28 lens (sold separately) with a teleconverter, etc., set [SteadyShot Adjust.] to [Manual] and set the focal length.
- When you set [SteadyShot] to [On]/[Off], the SteadyShot settings of the camera and lens switch at the same time.
- If a lens equipped with a SteadyShot switch is attached, the settings can only be changed using that switch on the lens. You cannot switch the settings using the camera.

### Related Topic

- [SteadyShot](#)



Interchangeable Lens Digital Camera  
ILCE-7M3 α7III

## Lens Comp.

Compensates for shading in the corners of the screen or distortion of the screen, or reduces color deviation at the corners of the screen caused by certain lens characteristics.

1 MENU →  (Camera Settings1) → [Lens Comp.] → desired setting.

### Menu item details

#### Shading Comp.:

Sets whether to automatically compensate for darkness in the corners of the screen. ([Auto]/[Off])

#### Chro. Aber. Comp.:

Sets whether to automatically reduce color deviation at the corners of the screen. ([Auto]/[Off])

#### Distortion Comp.:

Sets whether to automatically compensate for distortion of the screen. ([Auto]/[Off])



#### Note

- This function is only available when using an automatic compensation compliant lens.
- Darkness in the corners of the screen may not be corrected with [Shading Comp.], depending on the lens type.
- Depending on the attached lens, [Distortion Comp.] is fixed to [Auto], and you cannot select [Off].

Interchangeable Lens Digital Camera  
ILCE-7M3 α7III

## Long Exposure NR (still image)

When you set the shutter speed to 1 second(s) or longer (long exposure shooting), noise reduction is turned on for the duration that the shutter is open. With the function turned on, the grainy noise typical of long exposures is reduced.



1 MENU →  1 (Camera Settings1) → [ Long Exposure NR] → desired setting.

### Menu item details

**On:**  
Activates noise reduction for the same duration that the shutter is open. When noise reduction is in progress, a message appears and you cannot take another picture. Select this to prioritize the image quality.

**Off:**  
Does not activate noise reduction. Select this to prioritize the timing of shooting.



#### Note

- Noise reduction may not be activated even if [ Long Exposure NR] is set to [On] in the following situations:
  - [Drive Mode] is set to [Cont. Shooting] or [Cont. Bracket].
  - The shooting mode is set to [Scene Selection] and [Sports Action] is selected.
- [ Long Exposure NR] cannot be set to [Off] in the following shooting modes:
  - [Intelligent Auto]
  - [Scene Selection]
- Depending on the shooting conditions, the camera may not perform noise reduction, even if the shutter speed is 1 second(s) or longer.

Interchangeable Lens Digital Camera  
ILCE-7M3 α7III

## High ISO NR (still image)

When shooting with high ISO sensitivity, the product reduces noise that becomes more noticeable when the product sensitivity is high.

1 MENU →  1 (Camera Settings1) → [ High ISO NR] → desired setting.

### Menu item details

**Normal:**

Activates high ISO noise reduction normally.





**Low:**

Activates high ISO noise reduction moderately.

**Off:**

Does not activate high ISO noise reduction. Select this to prioritize the timing of shooting.

**Note**

- [ High ISO NR] is not available in the following shooting modes:
  - [Intelligent Auto]
  - [Scene Selection]
- When [ File Format] is set to [RAW], this function is not available.
- [ High ISO NR] does not work for RAW images when the [ File Format] is [RAW & JPEG].

Interchangeable Lens Digital Camera  
ILCE-7M3 α7III

## Regist. Faces Priority

---

Sets whether to focus with higher priority on faces registered using [Face Registration] when [Face Priority in AF] is set to [On].

1 MENU →  1 (Camera Settings1) → [Regist. Faces Priority] → desired setting.

### Menu item details

**On:**

Focuses with higher priority on faces registered using [Face Registration].

**Off:**

Focuses without giving higher priority to registered faces.

---

### Related Topic

- [Set. Face Prty in AF](#)
- [Face Registration \(New Registration\)](#)
- [Face Registration \(Order Exchanging\)](#)

Interchangeable Lens Digital Camera  
ILCE-7M3 α7III

## Face Registration (New Registration)

---

If you register faces in advance, the product can focus on the registered face as a priority when [Face Priority in AF] is set to [On].

- 1 MENU →  (Camera Settings1) → [Face Registration] → [New Registration].
- 2 Align the guide frame with the face to be registered, and press the shutter button.
- 3 When a confirmation message appears, select [Enter].

### Note

- Up to eight faces can be registered.
- Shoot the face from the front in a brightly lit place. The face may not be registered correctly if it is obscured by a hat, a mask, sunglasses, etc.

---

### Related Topic

- [Set. Face Prty in AF](#)

Interchangeable Lens Digital Camera  
ILCE-7M3 α7III

## Face Registration (Order Exchanging)

---

When multiple faces are registered to be given priority, the face registered first will be given priority. You can change the priority order.

- 1 MENU →  1 (Camera Settings1) → [Face Registration] → [Order Exchanging].
  - 2 Select a face to change the order of priority.
  - 3 Select the destination.
- 

### Related Topic

- [Set. Face Prty in AF](#)

Interchangeable Lens Digital Camera  
ILCE-7M3 α7III

## Face Registration (Delete)

---

Deletes a registered face.

**1** MENU →  1 (Camera Settings1) → [Face Registration] → [Delete].

If you select [Delete All], you can delete all registered faces.

### Note

- Even if you execute [Delete], the data for registered face will remain in the product. To delete the data for registered faces from the product, select [Delete All].

Interchangeable Lens Digital Camera  
ILCE-7M3 α7III

## Using flash (sold separately)

In dark environments, use the flash to light up the subject while shooting. Also use the flash to prevent camera-shake.

For details on the flash, refer to the instruction manual for the flash.

### 1 Attach the flash (sold separately) to the product.

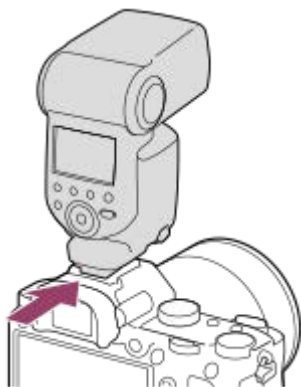

### 2 Shoot after you have turned on the flash and it is fully charged.

⚡● blinking: Charging is in progress

⚡● lit up: Charging is finished

- The available flash modes depend on the shooting mode and function.

#### Note

- The light of the flash may be blocked if the lens hood is attached and the lower part of a recorded image may be shaded. Remove the lens hood.
- When using the flash, stand 1 m or more away from the subject.
- You cannot use the flash when recording movies. (You can use an LED light when using a flash (sold separately) with an LED light.)
- Before attaching/removing an accessory such as a flash to/from the Multi Interface Shoe, turn off the product first. When attaching an accessory, make sure that the accessory is fixed securely to the product.
- Do not use the Multi Interface Shoe with a commercially available flash that applies voltage of 250 V or more or has the reverse polarity of the camera. Doing so may cause a malfunction.
- When shooting with the flash and the zoom is set to W, the shadow of the lens may appear on the screen, depending on the shooting conditions. If this happens, shoot away from the subject or set the zoom to T and shoot with the flash again.
- The corners of a recorded image may be shaded, depending on the lens.
- When shooting with an external flash, light and dark stripes may appear on the image if the shutter speed is set to faster than 1/4000 seconds. If this occurs, Sony recommends shooting in the manual flash mode and setting the flash level to 1/2 or higher.
- For details on compatible accessories for the Multi Interface Shoe, visit the Sony website, or consult your Sony dealer or local authorized Sony service facility.



---

---

**Related Topic**

- [Flash Mode](#)
- [Wireless Flash](#)

4-732-947-11(1) Copyright 2018 Sony Corporation

Interchangeable Lens Digital Camera  
ILCE-7M3 α7III

## Red Eye Reduction

---

When using the flash, it is fired two or more times before shooting to reduce the red-eye phenomenon.

**1** MENU →  1 (Camera Settings1) → [Red Eye Reduction] → desired setting.

### Menu item details

**On:**

The flash is always fired to reduce the red-eye phenomenon.

**Off:**

Does not use Red Eye Reduction.

**Note**

- Red Eye Reduction may not produce the desired effects. It depends on individual differences and conditions, such as distance to the subject, or whether the subject looks at the pre-strobe or not.

Interchangeable Lens Digital Camera  
ILCE-7M3 α7III

## Flash Mode

---

You can set the flash mode.

1 MENU →  1 (Camera Settings1) → [Flash Mode] → desired setting.

### Menu item details

#### Flash Off:

The flash does not operate.

#### Autoflash:

The flash works in dark environments or when shooting towards bright light.

#### Fill-flash:

The flash works every time you trigger the shutter.

#### Slow Sync.:

The flash works every time you trigger the shutter. Slow sync shooting allows you to shoot a clear image of both the subject and the background by slowing the shutter speed.

#### Rear Sync.:

The flash works right before the exposure is completed every time you trigger the shutter. Rear sync shooting allows you to shoot a natural image of the trail of a moving subject such as a moving car or a walking person.

#### Note

- The default setting depends on the shooting mode.
- Some [Flash Mode] settings are not available, depending on the shooting mode.

---

### Related Topic

- [Using flash \(sold separately\)](#)
- [Wireless Flash](#)

Interchangeable Lens Digital Camera  
ILCE-7M3 α7III

## Flash Comp.

Adjusts the amount of flash light in a range of  $-3.0$  EV to  $+3.0$  EV. Flash compensation changes the amount of flash light only. Exposure compensation changes the amount of flash light along with the change of the shutter speed and aperture.

1 MENU →  1 (Camera Settings1) → [Flash Comp.] → desired setting.

- Selecting higher values (+ side) makes the flash level higher, and lower values (- side) makes the flash level lower.

### Note

- [Flash Comp.] does not work when the shooting mode is set to the following modes:
  - [Intelligent Auto]
  - [Scene Selection]
- The higher flash effect (+ side) may not be visible due to the limited amount of flash light available, if the subject is outside the maximum range of the flash. If the subject is very close, the lower flash effect (- side) may not be visible.
- If you attach an ND filter to the lens or attach a diffuser or a color filter to the flash, the appropriate exposure may not be achieved and images may turn out dark. In this case, adjust [Flash Comp.] to the desired value.

### Related Topic



- [Using flash \(sold separately\)](#)

Interchangeable Lens Digital Camera  
ILCE-7M3 α7III

## FEL lock

The flash level is automatically adjusted so that the subject gets the optimum exposure during normal flash shooting. You can also set the flash level in advance.

FEL: Flash Exposure Level

1 MENU →  2 (Camera Settings2) → [ Custom Key] → desired button, then assign the [FEL Lock toggle] function to the button.

2 Center the subject on which FEL is to be locked, and adjust the focus.



3 Press the button to which [FEL Lock toggle] is registered, and set the flash amount.

- A pre-flash flashes.
- The  (FEL lock) lights up.

4 Adjust the composition and shoot the image.



- When you want to release the FEL lock, press the button to which the [FEL Lock toggle] is registered again.

### Hint

- By setting [FEL Lock hold], you can hold the setting while the button is pressed down. Also, by setting [FEL Lock/AEL hold] and [FEL Lock/AEL tgle.], you can shoot images with the AE locked in the following situations.
  - When [Flash Mode] is set to [Flash Off] or [Autoflash].
  - When the flash cannot go off.
  - When using an external flash that is set to manual flash mode.

### Note

- The FEL lock cannot be set when a flash is not attached.
- If a flash that does not support the FEL lock is attached, an error message is displayed.
- When both AE and FEL lock are fixed,  lights up.

---

### Related Topic

- [Custom Key \(still image/movie/playback\)](#)

4-732-947-11(1) Copyright 2018 Sony Corporation

Interchangeable Lens Digital Camera  
ILCE-7M3 α7III

## Wireless Flash

There are two methods for wireless flash shooting: light-signal flash shooting that uses the light of the flash attached to the camera as a signal light, and radio-signal flash shooting that uses wireless communication. To perform radio-signal flash shooting, use a compatible flash or the Wireless Radio Commander (sold separately). For details on how to set each method, refer to the instruction manual of the flash or the Wireless Radio Commander.

- 1 Remove the shoe cap from the camera, and then attach the flash or the Wireless Radio Commander.**
  - When performing wireless flash shooting with a flash attached, set the attached flash as the controller.
- 2 MENU →  1 (Camera Settings1) → [Wireless Flash] → [On].**
- 3 Set up an off-camera flash that is set to wireless mode, or that is attached to the Wireless Radio Receiver (sold separately).**
  - Press the AEL button on the camera to perform a test flashing.

### Menu item details

#### Off:

Does not use the wireless flash function.

#### On:

Uses the wireless flash function to make an external flash or flashes emit light at a distance from the camera.

### Setting of the AEL button

We recommend that you set MENU →  2 (Camera Settings2) → [ Custom Key] → [AEL Button] to [AEL hold] when performing wireless flash shooting.

#### Note

- The off-camera flash may emit light after receiving a light signal from a flash used as the controller of another camera. If this occurs, change the channel of your flash. For details on how to change the channel, refer to the instruction manual for the flash.
- For the flash that is compatible with wireless flash shooting, visit the Sony website, or consult your Sony dealer or local authorized Sony service facility.

Interchangeable Lens Digital Camera  
ILCE-7M3 α7III

## Shooting movies

You can record movies by pressing the MOVIE (Movie) button.

### 1 Press the MOVIE button to start recording.

- Since the [MOVIE Button] is set to [Always] in the default setting, movie recording can be started from any shooting mode.





### 2 Press the MOVIE button again to stop recording.

#### Hint

- You can assign the start/stop movie recording function to a preferred key. MENU → 2 (Camera Settings2) → Custom Key] → set [MOVIE] to the preferred key.
- When you want to specify the area to be focused on, set the area using [Focus Area].
- To keep the focus on a face, arrange the composition so that the focusing frame and face detection frame overlap, or set the [Focus Area] to [Wide].
- You can focus quickly while shooting movies by pressing the shutter button halfway down. (The sound of auto focus operation may be recorded in some cases.)
- To adjust the shutter speed and aperture value to the desired settings, set the shooting mode to (Movie) and select the desired exposure mode.
- An icon indicating that data is being written is displayed after shooting. Do not remove the memory card while the icon is displayed.
- The following settings for still image shooting are applied to the movie shooting:
  - White Balance
  - Creative Style
  - Metering Mode
  - Face Priority in AF
  - Face Prty in Mlti Mtr
  - D-Range Opt.
  - Lens Comp.
- You can change the settings for ISO sensitivity, exposure compensation, and focus area while shooting movies.
- While shooting movies, the recorded image can be output without the shooting information display by setting [HDMI Info. Display] to [Off].



## Note

- The sound of the lens and the product in operation may be recorded during movie recording. You can turn the sound off by selecting MENU → 2 (Camera Settings2) → [Audio Recording] → [Off].
- When shooting, the sound of the shoulder strap hooks (triangular hook) could be recorded, depending on the situation used.
- To prevent the operating sound of the zoom ring from being recorded during movie recording when a power zoom lens is used, we recommend recording movies using the zoom lever. When you move the zoom lever, place your finger lightly on the lever and operate it without flicking.
- The temperature of the camera tends to rise when shooting movies continuously, and you may feel that the camera is warm. This is not a malfunction. Also, [Internal temp. high. Allow it to cool.] may appear. In such cases, turn the power off and cool the camera and wait until the camera is ready to shoot again.
- If the  icon appears, the temperature of the camera has risen. Turn the power off and cool the camera and wait until the camera is ready to shoot again.
- For the continuous shooting time of a movie recording, refer to “Recordable movie times.” When movie recording is finished, you can restart recording by pressing the MOVIE button again. Recording may stop to protect the product, depending on the temperature of the product or the battery.
- When the mode dial is set to  (Movie) or **S&Q** or when shooting movies, you cannot select [Lock-on AF] for [Focus Area].
- In [Program Auto] mode when shooting movies, the aperture value and the shutter speed will be set automatically and cannot be changed. For that reason, the shutter speed may become fast in a bright environment, and the motion of the subject may not record smoothly. By changing the exposure mode and adjusting the aperture value and the shutter speed, the motion of the subject can be recorded smoothly.
- When shooting movies, ISO values between ISO 100 and ISO 102400 are available. If the ISO value is set to a value larger than ISO 102400, the setting is automatically switched to ISO 102400. When you finish recording the movie, the ISO value returns to the original setting.
- In movie shooting mode, ISO sensitivity can be selected from ISO 100 to ISO 102400. If the ISO value is set to a value smaller than ISO 100, the setting is automatically switched to ISO 100. When you finish recording the movie, the ISO value returns to the original setting.
- In movie shooting mode, the following settings cannot be set in [Picture Effect]. When a movie recording starts, [Off] will be set temporarily.
  - Rich-tone Mono.
- If you point the camera at an extremely strong light source while shooting a movie at low ISO sensitivity, the highlighted area in the image may be recorded as a black area.
- If the display mode of the monitor is set to [For viewfinder], the display mode will switch to [Display All Info.] when movie shooting starts.
- Use PlayMemories Home when importing XAVC S movies and AVCHD movies to a computer.

---

## Related Topic

- [MOVIE Button](#)
- [Movie w/ shutter](#)
- [File Format \(movie\)](#)
- [Recordable movie times](#)
- [Custom Key \(still image/movie/playback\)](#)
- [Focus Area](#)

Interchangeable Lens Digital Camera  
ILCE-7M3 α7III

## Movie w/ shutter

---

You can start or stop recording movies by pressing the shutter button, which is bigger and easier to press than the MOVIE (Movie) button.

1 MENU →  2 (Camera Settings2) → [Movie w/ shutter] → desired setting.

### Menu item details

#### On:

Enables movie recording using the shutter button when the shooting mode is set to [Movie] or [S&Q Motion].

#### Off:

Disables movie recording using the shutter button.

#### Hint

- When [Movie w/ shutter] is set to [On], you can still start or stop recording movies using the MOVIE button.
- When [Movie w/ shutter] is set to [On], you can use the shutter button to start or stop recording movies on an external recording/playback device using [ REC Control].

#### Note

- When [Movie w/ shutter] is set to [On], you cannot focus by pressing the shutter button halfway down during movie recording.

---

### Related Topic

- [Shooting movies](#)

Interchangeable Lens Digital Camera  
ILCE-7M3 α7III

## Movie recording formats

---

The following movie recording formats are available with this camera.

### What is XAVC S?

Records movies in high definition such as 4K by converting them into MP4 movies using the MPEG-4 AVC/H.264 codec. MPEG-4 AVC/H.264 is capable of compressing images with higher efficiency. You can record high-quality images while reducing the amount of data.

### XAVC S/AVCHD recording format

#### XAVC S 4K:

Bit-rate: Approx. 100 Mbps or approx. 60 Mbps

Records movies in 4K resolution (3840×2160).

#### XAVC S HD:

Bit-rate: Approx. 100 Mbps, approx. 60 Mbps, approx. 50 Mbps, approx. 25 Mbps, or approx. 16 Mbps

Records movies in crisper quality than AVCHD with larger amounts of data.

#### AVCHD:

Bit-rate: Approx. 24 Mbps (maximum) or approx. 17 Mbps (average)

The AVCHD format has a high degree of compatibility with storage devices other than computers.

- Bit rate is the amount of data processed within a given period of time.

---



### Related Topic

- [File Format \(movie\)](#)
- [Record Setting \(movie\)](#)
- [AVCHD format](#)

Interchangeable Lens Digital Camera  
ILCE-7M3 α7III

## File Format (movie)



Selects the movie file format.

1 MENU →  2 (Camera Settings2) → [ File Format] → desired setting.

### Menu item details

 File Format	Characteristics	
XAVC S 4K	Records movies in 4K resolution (3840×2160).	You can save movies on a computer using the PlayMemories Home software.
XAVC S HD	Records movies in crisper quality than AVCHD with larger amounts of data.	You can save movies on a computer using the PlayMemories Home software.
AVCHD	The AVCHD format has a high degree of compatibility with storage devices other than computers.	You can save movies on a computer or create a disc that supports this format using the PlayMemories Home software.



#### Note

- When [ File Format] is set to [AVCHD], the file size of movies is limited to approx. 2 GB. If the movie file size reaches approx. 2 GB during recording, a new movie file will be created automatically.
- If you set [ File Format] to [XAVC S 4K] and shoot movies while the camera is connected to an HDMI device, images will not be displayed on the monitor.

Interchangeable Lens Digital Camera  
ILCE-7M3 α7III

## Record Setting (movie)

Selects the frame rate and bit-rate for movie recording.

1 MENU →  2 (Camera Settings2) → [ Record Setting] → desired setting.

- The higher the bit-rate, the higher the image quality.

### Menu item details

When [ File Format] is set to [XAVC S 4K]

 Record Setting	Bit-rate	Description
30p 100M/25p 100M	Approx. 100 Mbps	Records movies in 3840×2160 (30p/25p).
30p 60M/25p 60M	Approx. 60 Mbps	Records movies in 3840×2160 (30p/25p).
24p 100M*	Approx. 100 Mbps	Records movies in 3840×2160 (24p).
24p 60M*	Approx. 60 Mbps	Records movies in 3840×2160 (24p).

\* Only when [NTSC/PAL Selector] is set to NTSC

When [ File Format] is set to [XAVC S HD]

 Record Setting	Bit-rate	Description
60p 50M/50p 50M	Approx. 50 Mbps	Records movies in 1920×1080 (60p/50p).
60p 25M/50p 25M	Approx. 25 Mbps	Records movies in 1920×1080 (60p/50p).
30p 50M/25p 50M	Approx. 50 Mbps	Records movies in 1920×1080 (30p/25p).
30p 16M/25p 16M	Approx. 16 Mbps	Records movies in 1920×1080 (30p/25p).
24p 50M*	Approx. 50 Mbps	Records movies in 1920×1080 (24p).
120p 100M/100p 100M	Approx. 100 Mbps	Records high-speed movies in 1920×1080 (120p/100p). You can record movies in 120 fps or 100 fps. <ul style="list-style-type: none"> <li>• You can create smoother slow-motion movies by using compatible editing devices.</li> </ul>



 Record Setting	Bit-rate	Description
120p 60M/100p 60M	Approx. 60 Mbps	Records high-speed movies in 1920×1080 (120p/100p). You can record movies in 120 fps or 100 fps. <ul style="list-style-type: none"> <li>You can create smoother slow-motion movies by using compatible editing devices.</li> </ul>

\* Only when [NTSC/PAL Selector] is set to NTSC

### When [ File Format] is set to [AVCHD]

 Record Setting	Bit-rate	Description
60i 24M(FX)/50i 24M(FX)	24 Mbps at maximum	Records movies in 1920×1080 (60i/50i).
60i 17M(FH)/50i 17M(FH)	Approx. 17 Mbps on average	Records movies in 1920×1080 (60i/50i).

#### Note



- Creating an AVCHD recording disc from movies that were recorded with [60i 24M(FX)]/[50i 24M(FX)] as the [ Record Setting] takes a long time because the image quality of movies is converted. If you want to store movies without converting them, use a Blu-ray Disc.
- [120p]/[100p] cannot be selected for the following settings.
  - [Intelligent Auto]
  - [Scene Selection]
- In full-frame shooting, the angle of view will be narrower under the following conditions:
  - When [ File Format] is set to [XAVC S 4K] and [ Record Setting] is set to [30p]

#### Related Topic

- [APS-C/Super 35mm](#)
- [Angle of view](#)

## S&Q Settings

You can record a moment that cannot be captured by the naked eye (slow-motion recording), or record a long-term phenomenon into a compressed movie (quick-motion recording). For example, you can record an intense sports scene, the moment when a bird starts to fly, a blooming flower, and a changing view of clouds or a starry sky. Sound will not be recorded.

- 1 Set the mode dial to **S&Q** (S&Q Motion).
- 2 Select MENU →  (Camera Settings2) → [ **S&Q** Exposure Mode ] → and select the desired setting of slow-motion/quick-motion ( **S&Q** Program Auto, **S&Q** Aperture Priority, **S&Q** Shutter Priority, or **S&Q** Manual Exposure).
- 3 Select MENU →  (Camera Settings2) → [ **S&Q** S&Q Settings ] and select the desired settings for [ **S&Q** Record Setting ] and [ **S&Q** Frame Rate ].
- 4 Press the **MOVIE** (movie) button to start recording.
  - Press the **MOVIE** button again to stop recording.

### Menu item details

**S&Q Record Setting:**

Selects the frame rate of the movie.

**S&Q Frame Rate:**

Selects the shooting frame rate.

### Playback speed

The playback speed will vary as below depending on the assigned [ **S&Q** Record Setting ] and [ **S&Q** Frame Rate ].

#### When [NTSC/PAL Selector] is set to NTSC

<b>S&amp;Q</b> Frame Rate	<b>S&amp;Q</b> Record Setting		
	24p	30p	60p
120fps	5 times slower	4 times slower	-
60fps	2.5 times slower	2 times slower	Normal playback speed
30fps	1.25 times slower	Normal playback speed	2 times quick
15fps	1.6 times quick	2 times quick	4 times quick
8fps	3 times quick	3.75 times quick	7.5 times quick
4fps	6 times quick	7.5 times quick	15 times quick
2fps	12 times quick	15 times quick	30 times quick
1fps	24 times quick	30 times quick	60 times quick

## When [NTSC/PAL Selector] is set to PAL

S&Q Frame Rate	S&Q Record Setting	
	25p	50p
100fps	4 times slower	-
50fps	2 times slower	Normal playback speed
25fps	Normal playback speed	2 times quick
12fps	2.08 times quick	4.16 times quick
6fps	4.16 times quick	8.3 times quick
3fps	8.3 times quick	16.6 times quick
2fps	12.5 times quick	25 times quick
1fps	25 times quick	50 times quick

- When [S&Q Frame Rate] is set to [120fps]/[100fps], you cannot set [S&Q Record Setting] to [60p]/[50p].

### Note

- In slow-motion recording, the shutter speed becomes faster and you may not be able to obtain the proper exposure. If this happens, decrease the aperture value or adjust the ISO sensitivity to a higher value.
- For an estimation of recordable time, refer to "Recordable movie times."
- The bit-rate of a recorded movie varies depending on the settings for [S&Q Frame Rate] and [S&Q Record Setting].
- The movie will be recorded in XAVC S HD format.
- During slow-motion/quick-motion recording, the following functions are not available.
  - [TC Run] under [TC/UB Settings]
  - [TC Output] under [HDMI Settings]
  - [4K Output Sel.]

### Related Topic

- [S&Q Motion: Exposure Mode](#)
- [Recordable movie times](#)



Interchangeable Lens Digital Camera  
ILCE-7M3 α7III

## Proxy Recording

Sets whether to simultaneously record low-bit-rate proxy movies when recording XAVC S movies. Since proxy movies are small in file size, they are suitable for transferring to smartphones or uploading to websites.

1 MENU →  2 (Camera Settings2) → [**Px** Proxy Recording] → desired setting.

### Menu item details

#### On :

Proxy movies are simultaneously recorded.



#### Off :

Proxy movies are not recorded.

#### Hint

- Proxy movies are recorded in the XAVC S HD format (1280×720) at 9 Mbps. The frame rate of the proxy movie is the same as that of the original movie.
- Proxy movies are not displayed on the playback screen (single-image playback screen or image index screen). **Px** is displayed over movies for which a proxy movie was simultaneously recorded.

#### Note

- Proxy movies cannot be played back on this camera.
- Proxy recording is not available in the following situations.
  - When [ File Format] is set to [AVCHD]
  - When [ File Format] is set to [XAVC S HD] and [ Record Setting] is set to [120p]/[100p]
- Deleting/protecting movies that have proxy movies removes/protects both the original and proxy movies. You cannot delete/protect only original movies or proxy movies.
- Movies cannot be edited on this camera.

### Related Topic

- [Snd to Smrtphn Func: Sending Target \(proxy movies\)](#)
- [Movie recording formats](#)
- [Playing back images on the image index screen \(Image Index\)](#)
- [Memory cards that can be used](#)

Interchangeable Lens Digital Camera  
ILCE-7M3 α7III

## Audio Recording

---

Sets whether to record sounds when shooting movies. Select [Off] to avoid recording the sounds of the lens and the camera operating.

**1** MENU →  2 (Camera Settings2) → [Audio Recording] → desired setting.

### Menu item details

**On:**

Records sound (stereo).

**Off:**

Does not record sound.

Interchangeable Lens Digital Camera  
ILCE-7M3 α7III

## Audio Level Display

---

Sets whether to display the audio level on the screen.

**1** MENU →  2 (Camera Settings2) → [Audio Level Display] → desired setting.

### Menu item details

**On:**

Displays the audio level.

**Off:**

Does not display the audio level.

**Note**

- The audio level is not displayed in the following situations:
  - When [Audio Recording] is set to [Off].
  - When DISP (Display Setting) is set to [No Disp. Info].
  - During slow-motion/quick-motion shooting
- The audio level is also displayed while shooting stand-by in movie recording mode.

Interchangeable Lens Digital Camera  
ILCE-7M3 α7III

## Audio Rec Level

---

You can adjust the audio recording level while checking the level meter.

- 1 MENU →  2 (Camera Settings2) → [Audio Rec Level].
- 2 Select the desired level using the right/left sides of the control wheel.

### Menu item details

+:

Turns up the audio recording level.

-:

Turns down the audio recording level.

**Reset:**

Resets the audio recording level to the default setting.

#### Hint

- When you record audio movies with loud volumes, set [Audio Rec Level] to a lower sound level. Doing so enables you to record more realistic audio. When you record audio movies with lower volumes, set [Audio Rec Level] to a greater sound level to make the sound easier to hear.

#### Note

- Regardless of the [Audio Rec Level] settings, the limiter always operates.
- [Audio Rec Level] is available only when the shooting mode is set to movie mode.
- [Audio Rec Level] is unavailable during slow-motion/quick-motion shooting.
- The [Audio Rec Level] settings are applied for both the internal microphone and the  (microphone) terminal input.

Interchangeable Lens Digital Camera  
ILCE-7M3 α7III

## Audio Out Timing

---

You can set echo cancellation during audio monitoring and prevent undesirable deviations between video and audio during HDMI output.

**1** MENU →  2 (Camera Settings2) → [Audio Out Timing] → desired setting.

### Menu item details

**Live:**

Outputs audio without delay. Select this setting when audio deviation is a problem during audio monitoring.

**Lip Sync:**

Outputs audio and video in sync. Select this setting to prevent undesirable deviations between video and audio.

Interchangeable Lens Digital Camera  
ILCE-7M3 α7III

## Wind Noise Reduct.

---

Sets whether or not to reduce wind noise by cutting the low-range sound of the input audio from the built-in microphone.

**1** MENU →  2 (Camera Settings2) → [Wind Noise Reduct.] → desired setting.

### Menu item details

**On:**

Reduces wind noise.

**Off:**

Does not reduce wind noise.

**Note**

- Setting this item to [On] where wind is not blowing sufficiently hard may cause normal sound to be recorded with too low volume.
- When an external microphone (sold separately) is used, [Wind Noise Reduct.] does not function.

Interchangeable Lens Digital Camera  
ILCE-7M3 α7III

## Picture Profile

Allows you to change the settings for the color, gradation, etc. For details on "Picture Profile," refer to <http://helpguide.sony.net/di/pp/v1/en/index.html>.

### Customizing the picture profile

You can customize the picture quality by adjusting picture profile items such as [Gamma] and [Detail]. When setting these parameters, connect the camera to a TV or monitor, and adjust them while observing the picture on the screen.

- 1 MENU →  1 (Camera Settings1) → [Picture Profile] → the profile you want to change.
- 2 Move to the item index screen by pressing the right side of the control wheel.
- 3 Select the item to change using the top/bottom sides of the control wheel.
- 4 Select the desired value using the top/bottom sides of the control wheel and press in the center.

### Using the preset of the picture profile

The default settings [PP1] through [PP10] for movies have been set in advance in the camera based on various shooting conditions.

MENU →  1 (Camera Settings1) → [Picture Profile] → desired setting.

#### PP1:

Example setting using [Movie] gamma.

#### PP2:

Example setting using [Still] gamma.

#### PP3:

Example setting of natural color tone using the [ITU709] gamma.

#### PP4:

Example setting of a color tone faithful to the ITU709 standard.

#### PP5:

Example setting using [Cine1] gamma.

#### PP6:

Example setting using [Cine2] gamma.

#### PP7:

Example setting using [S-Log2] gamma.

#### PP8:

Example setting using the [S-Log3] gamma and the [S-Gamut3.Cine] under [Color Mode].

#### PP9:

Example setting using the [S-Log3] gamma and the [S-Gamut3] under [Color Mode].

#### PP10:

Example setting for recording HDR movies using [HLG2] gamma.

### HDR movie recording

The camera can record HDR movies when a gamma from [HLG], [HLG1] to [HLG3] is selected in the picture profile. Picture profile preset [PP10] provides an example setting for HDR recording. Movies recorded using [PP10] can be viewed with a wider range of brightness than usual when played back on a TV supporting Hybrid Log-Gamma (HLG).

This way, even scenes with a wide range of brightness can be recorded and displayed faithfully, without looking under or over-exposed. HLG is used in HDR TV program production, as defined in the international standard Recommendation ITU-R BT.2100.

## Items of the picture profile

### Black Level

Sets the black level. (-15 to +15)

### Gamma

Selects a gamma curve.

Movie: Standard gamma curve for movies

Still: Standard gamma curve for still images

Cine1: Softens the contrast in dark parts and emphasizes gradation in bright parts to produce a relaxed color movie. (equivalent to HG4609G33)

Cine2: Similar to [Cine1] but optimized for editing with up to 100% video signal. (equivalent to HG4600G30)

Cine3: Intensifies the contrast in light and shade more than [Cine1] and strengthens gradation in black.

Cine4: Strengthens the contrast in dark parts more than [Cine3].

ITU709: Gamma curve that corresponds to ITU709.

ITU709(800%): Gamma curve for confirming scenes on the assumption of shooting using [S-Log2] or [S-Log3].

S-Log2: Gamma curve for [S-Log2]. This setting is based on the assumption that the picture will be processed after shooting.

S-Log3: Gamma curve for [S-Log3] with more similar features to film. This setting is based on the assumption that the picture will be processed after shooting.

HLG: Gamma curve for HDR recording. Equivalent to the HDR standard Hybrid Log-Gamma, ITU-R BT.2100.

HLG1: Gamma curve for HDR recording. Emphasizes noise reduction. However, shooting is restricted to a narrower dynamic range than with [HLG2] or [HLG3].

HLG2: Gamma curve for HDR recording. Provides a balance of dynamic range and noise reduction.

HLG3: Gamma curve for HDR recording. Wider dynamic range than [HLG2]. However, noise may increase.

- [HLG1], [HLG2], and [HLG3] all apply a gamma curve with the same characteristics, but each offers a different balance between dynamic range and noise reduction. Each has a different maximum video output level, as follows: [HLG1]: approx. 87%, [HLG2]: approx. 95%, [HLG3]: approx. 100%.

### Black Gamma

Corrects gamma in low intensity areas.

[Black Gamma] is fixed at "0" and cannot be adjusted when [Gamma] is set to [HLG], [HLG1], [HLG2], or [HLG3].

Range: Selects the correcting range. (Wide / Middle / Narrow)

Level: Sets the correcting level. (-7 (maximum black compression) to +7 (maximum black stretch))

### Knee

Sets knee point and slope for video signal compression to prevent over-exposure by limiting signals in high intensity areas of the subject to the dynamic range of your camera.

[Knee] is disabled if [Mode] is set to [Auto] when [Gamma] is set to [Still], [Cine1], [Cine2], [Cine3], [Cine4], [ITU709(800%)], [S-Log2], [S-Log3], [HLG], [HLG1], [HLG2], or [HLG3]. To enable [Knee], set [Mode] to [Manual].

Mode: Selects auto/manual settings.

- Auto: The knee point and slope are set automatically.
- Manual: The knee point and slope are set manually.

Auto Set: Settings when [Auto] is selected for [Mode].

- Max Point: Sets the maximum point of the knee point. (90% to 100%)
- Sensitivity: Sets the sensitivity. (High / Mid / Low)

Manual Set: Settings when [Manual] is selected for [Mode].

- Point: Sets the knee point. (75% to 105%)



- Slope: Sets the knee slope. (-5 (gentle) to +5 (steep))

### Color Mode

Sets type and level of colors.

In [Color Mode], only [BT.2020] and [709] are available when [Gamma] is set to [HLG], [HLG1], [HLG2], or [HLG3].

Movie: Suitable colors when [Gamma] is set to [Movie].

Still: Suitable colors when [Gamma] is set to [Still].

Cinema: Suitable colors when [Gamma] is set to [Cine1] or [Cine2].

Pro: Similar color tones to the standard image quality of Sony professional cameras (when combined with ITU709 gamma)

ITU709 Matrix: Colors corresponding to ITU709 standard (when combined with ITU709 gamma)

Black & White: Sets the saturation to zero for shooting in black and white.

S-Gamut: Setting based on the assumption that the pictures will be processed after shooting. Used when [Gamma] is set to [S-Log2].

S-Gamut3.Cine: Setting based on the assumption that the pictures will be processed after shooting. Used when [Gamma] is set to [S-Log3]. This setting allows you to shoot in a color space that can easily be converted for digital cinema.

S-Gamut3: Setting based on the assumption that the pictures will be processed after shooting. Used when [Gamma] is set to [S-Log3]. This setting allows you to shoot in a wide color space.

BT.2020: Standard color tone when [Gamma] is set to [HLG], [HLG1], [HLG2], or [HLG3].

709: Color tone when [Gamma] is set to [HLG], [HLG1], [HLG2], or [HLG3] and movies are recorded with HDTV color (BT.709).

### Saturation

Sets the color saturation. (-32 to +32)

### Color Phase

Sets the color phase. (-7 to +7)

### Color Depth

Sets the color depth for each color phase. This function is more effective for chromatic colors and less effective for achromatic colors. The color looks deeper as you increase the setting value towards the positive side, and lighter as you decrease the value towards the negative side. This function is effective even if you set [Color Mode] to [Black & White].

[R] -7 (light red) to +7 (deep red)

[G] -7 (light green) to +7 (deep green)

[B] -7 (light blue) to +7 (deep blue)

[C] -7 (light cyan) to +7 (deep cyan)

[M] -7 (light magenta) to +7 (deep magenta)

[Y] -7 (light yellow) to +7 (deep yellow)

### Detail

Sets items for [Detail].

Level: Sets the [Detail] level. (-7 to +7)

Adjust: The following parameters can be selected manually.

- Mode: Selects auto/manual setting. (Auto (automatic optimization) / Manual (The details are set manually.))
- V/H Balance: Sets the vertical (V) and horizontal (H) balance of DETAIL. (-2 (off to the vertical (V) side) to +2 (off to the horizontal (H) side))
- B/W Balance: Selects the balance of the lower DETAIL (B) and the upper DETAIL (W). (Type1 (off to the lower DETAIL (B) side) to Type5 (off to the upper DETAIL (W) side))
- Limit: Sets the limit level of [Detail]. (0 (Low limit level: likely to be limited) to 7 (High limit level: unlikely to be limited))
- Crisping: Sets the crisping level. (0 (shallow crisping level) to 7 (deep crisping level))
- Hi-Light Detail: Sets the [Detail] level in the high intensity areas. (0 to 4)

### To copy the settings to another picture profile number

You can copy the settings of the picture profile to another picture profile number.

MENU →  1 (Camera Settings1) → [Picture Profile] → [Copy].

### To Reset the picture profile to the default setting

You can reset the picture profile to the default setting. You cannot reset all picture profile settings at once.

MENU →  1 (Camera Settings1) → [Picture Profile] → [Reset].

#### Note

- Since the parameters are shared for movie and still images, adjust the value when you change the shooting mode.
- If you develop RAW images with shooting settings, the following settings are not reflected:
  - Black Level
  - Black Gamma
  - Knee
  - Color Depth
- If you change [Gamma], the available ISO value range changes.
- There may be more noise in dark parts depending on the gamma settings. It may improve by setting the lens compensation to [Off].
- When using S-Log2 or S-Log3 gamma, the noise becomes more noticeable compared to when using other gammas. If the noise still is significant even after processing pictures, it may be improved by shooting with a brighter setting. However, the dynamic range becomes narrower accordingly when you shoot with a brighter setting. We recommend checking the picture in advance by test shooting when using S-Log2 or S-Log3.
- Setting [ITU709(800%)], [S-Log2] or [S-Log3] may cause an error in the white balance custom setup. In this case, perform custom setup with a gamma other than [ITU709(800%)], [S-Log2], or [S-Log3] first, and then reselect [ITU709(800%)], [S-Log2], or [S-Log3] gamma.
- Setting [ITU709(800%)], [S-Log2] or [S-Log3] disables the [Black Level] setting.
- If you set [Slope] to +5 in [Manual Set] under [Knee], [Knee] is set to [Off].
- S-Gamut, S-Gamut3.Cine, and S-Gamut3 are color spaces exclusive to Sony. However, this camera's S-Gamut setting does not support the whole S-Gamut color space; it is a setting to achieve a color reproduction equivalent to S-Gamut.

---

#### Related Topic

- [Gamma Disp. Assist](#)

Interchangeable Lens Digital Camera  
ILCE-7M3 α7III

## Gamma Disp. Assist

Movies with S-Log gamma are assumed to be processed after shooting in order to make use of the wide dynamic range. Movies with the HLG gamma are assumed to be displayed on HDR-compatible monitors. They are therefore displayed in low contrast during shooting and may be difficult to monitor, using [Gamma Disp. Assist], contrast equivalent to that of normal gamma can be reproduced. In addition, [Gamma Disp. Assist] can also be applied when playing back movies on the camera's monitor/viewfinder.

- 1 **MENU** →  (Setup) → [Gamma Disp. Assist].
- 2 Select the desired setting using the top/bottom sides of the control wheel.

### Menu item details

Assist  
OFF **Off:**

Does not apply [Gamma Disp. Assist].

Assist  
AUTO **Auto:**

Displays movies with an [S-Log2→709(800%)] effect when the gamma set in [Picture Profile] is [S-Log2], and with an [S-Log3→709(800%)] effect when the gamma is set to [S-Log3]. Displays movies with an [HLG(BT.2020)] effect when the gamma set in [Picture Profile] is [HLG], [HLG1], [HLG2] or [HLG3], and [Color Mode] is set to [BT.2020].

Displays movies with an [HLG(709)] effect when the gamma set in [Picture Profile] is [HLG], [HLG1], [HLG2] or [HLG3], and [Color Mode] is set to [709].

Assist  
S-Log2 **S-Log2→709(800%):**

Displays movies with an S-Log2 gamma reproducing contrast equivalent to ITU709 (800%).

Assist  
S-Log3 **S-Log3→709(800%):**

Displays movies with an S-Log3 gamma reproducing contrast equivalent to ITU709 (800%).

Assist  
HLG 2020 **HLG(BT.2020):**

Displays movies after adjusting the image quality of the monitor or viewfinder to a quality that is almost the same as when movies are displayed on an [HLG(BT.2020)] compatible monitor.

Assist  
HLG 709 **HLG(709):**

Displays movies after adjusting the image quality of the monitor or viewfinder to a quality that is almost the same as when movies are displayed on an [HLG(709)] compatible monitor.

### Note

- Movies in the XAVC S 4K or XAVC S HD format with the [HLG], [HLG1], [HLG2], or [HLG3] gamma are displayed with an [HLG(BT.2020)] effect or [HLG(709)] effect depending on the movie's gamma value and color mode. In other situations, movies are displayed according to the gamma setting and color mode setting in [Picture Profile].
- [Gamma Disp. Assist] is not applied to movies when displayed on a TV or monitor connected to the camera.



### Related Topic

- [Picture Profile](#)

Interchangeable Lens Digital Camera  
ILCE-7M3 α7III

## Auto Slow Shut. (movie)

Sets whether or not to adjust the shutter speed automatically when recording movies if the subject is dark.

1 MENU →  2 (Camera Settings2) → [ Auto Slow Shut.] → desired setting.

### Menu item details



#### On:

Uses Auto Slow Shutter. The shutter speed automatically slows when recording in dark locations. You can reduce noise in the movie by using a slow shutter speed when recording in dark locations.

#### Off:

Does not use Auto Slow Shutter. The recorded movie will be darker than when [On] is selected, but you can record movies with smoother motion and less object blur.

#### Note



- [ Auto Slow Shut.] does not function in the following situations:
  - During slow-motion/quick-motion shooting
  -  (Shutter Priority)
  -  (Manual Exposure)
  - When [ISO] is set to other than [ISO AUTO]

Interchangeable Lens Digital Camera  
ILCE-7M3 α7III

## AF drive speed (movie)

---

You can switch focusing speed when using autofocus in movie mode.

**1** MENU →  2 (Camera Settings2) → [ AF drive speed] → desired setting.

### Menu item details

**Fast:**

Sets the AF drive speed to fast. This mode is suitable for shooting active scenes, such as sports.

**Normal:**

Sets the AF drive speed to normal.

**Slow:**



Sets the AF drive speed to slow. With this mode, the focus switches smoothly when the subject to be focused is changed.

Interchangeable Lens Digital Camera  
ILCE-7M3 α7III

## AF Track Sens (movie)

---

You can set the AF sensitivity in movie mode.

**1** MENU →  2 (Camera Settings2) → [ AF Track Sens] → desired setting.

### Menu item details

**Responsive:**

Sets the AF sensitivity to high. This mode is useful when recording movies in which the subject is moving quickly.

**Standard:**

Sets the AF sensitivity to normal. This mode is useful when there are obstacles in front of the subject or in crowded places.

Interchangeable Lens Digital Camera  
ILCE-7M3 α7III

## TC/UB Settings

The time code (TC) and the user bit (UB) information can be recorded as data attached to movies.

- 1 MENU →  (Setup) → [TC/UB Settings] → setting value you want to change.

### Menu item details

#### TC/UB Disp. Setting:

Sets the display for the counter, time code, and user bit.

#### TC Preset:

Sets the time code.

#### UB Preset:

Sets the user bit.

#### TC Format:

Sets the recording method for the time code. (Only when [NTSC/PAL Selector] is set to NTSC.)

#### TC Run:

Sets the count up format for the time code.

#### TC Make:

Sets the recording format for the time code on the recording medium.



#### UB Time Rec:

Sets whether or not to record the time as a user bit.

### How to set the time code (TC Preset)

1. MENU →  (Setup) → [TC/UB Settings] → [TC Preset].
2. Turn the control wheel and select the first two digits.
  - The time code can be set between the following range.
    - When [60i] is selected: 00:00:00:00 to 23:59:59:29
    - \* When [24p] is selected, you can select the last two digits of the time code in multiples of four from 0 to 23 frames.
    - When [50i] is selected: 00:00:00:00 to 23:59:59:24
3. Set the other digits following the same procedure as in step 2, then press in the center of the control wheel.



### How to reset the time code

1. MENU →  (Setup) → [TC/UB Settings] → [TC Preset].
  2. Press the  (Delete) button to reset the time code (00:00:00:00).
- You can also reset the time code (00:00:00:00) using the RMT-VP1K remote commander (sold separately).

### How to set the user bit (UB Preset)

1. MENU →  (Setup) → [TC/UB Settings] → [UB Preset].
2. Turn the control wheel and select the first two digits.
3. Set the other digits following the same procedure as in step 2, then press in the center of the control wheel.

### How to reset the user bit

1. MENU →  (Setup) → [TC/UB Settings] → [UB Preset].
2. Press the  (Delete) button to reset the user bit (00 00 00 00).

### How to select the recording method for the time code (TC Format<sup>\*1</sup>)

1. MENU →  (Setup) → [TC/UB Settings] → [TC Format].

#### **DF:**

Records the time code in Drop Frame<sup>\*2</sup> format.

#### **NDF:**

Records the time code in Non-Drop Frame format.

\*1 Only when [NTSC/PAL Selector] is set to NTSC.

\*2 The time code is based on 30 frames per second. However, a gap between the actual time and the time code will occur during extended periods of recording as the frame frequency of the NTSC image signal is approximately 29.97 frames per second. Drop frame corrects this gap to make the time code and actual time equal. In drop frame, the first 2 frame numbers are removed every minute except for every tenth minute. The time code without this correction is called non-drop frame.

- The setting is fixed to [NDF] when recording in 4K/24p or 1080/24p.

### **How to select the count up format for the time code (TC Run)**

1. MENU →  (Setup) → [TC/UB Settings] → [TC Run].

#### **Rec Run:**

Sets the stepping mode for the time code to advance only while recording. The time code is recorded sequentially from the last time code of the previous recording.

#### **Free Run:**

Sets the stepping mode for the time code to advance anytime, regardless of the camera operation.

- The time code may not be recorded sequentially in the following situations even when the time code advances in [Rec Run] mode.
  - When the recording format is changed.
  - When the recording medium is removed.







### **How to select how the time code is recorded (TC Make)**

1. MENU →  (Setup) → [TC/UB Settings] → [TC Make].

#### **Preset:**

Records the newly set time code on the recording medium.

#### **Regenerate:**





Reads the last time code for the previous recording from the recording medium and records the new time code consecutively from the last time code. The time code is read from the memory card in the slot 1 when [Recording Mode] under [Rec. Media Settings] is set to [Simult. (  )] or [Simult. (  /  )]. The time code is read from the memory card to which the movies will be recorded when [Recording Mode] is set to [Standard], [Simult. (  )], [Sort(RAW/JPEG)], [Sort(JPEG/RAW)] or [Sort(  /  )]. The time code advances in [Rec Run] mode regardless of the [TC Run] setting.



Interchangeable Lens Digital Camera  
ILCE-7M3 α7III

## TC/UB Disp. Switch

Allows you to display the time code (TC) and user bit (UB) of a movie by pressing the key to which [TC/UB Disp. Switch] function has been assigned.

- 1 MENU →  2 (Camera Settings2) → [ Custom Key], [ Custom Key], or [ Custom Key] → assign the [TC/UB Disp. Switch] function to the desired key.
- 2 Press the key to which [TC/UB Disp. Switch] is assigned.
  - Each time you press the key, the monitor display will switch from the movie recording time counter → time code (TC) → user bit (UB), in that order.

Interchangeable Lens Digital Camera  
ILCE-7M3 α7III

## MOVIE Button

---

Sets whether or not to activate the MOVIE (Movie) button.

**1** MENU →  2 (Camera Settings2) → [MOVIE Button] → desired setting.

### Menu item details

**Always:**

Starts movie recording when you press the MOVIE button in any mode.

**Movie Mode Only:**



Starts movie recording when you press the MOVIE button only if the shooting mode is set to [Movie] or [S&Q Motion] mode.

Interchangeable Lens Digital Camera  
ILCE-7M3 α7III

## Marker Display (movie)

---

Sets whether or not to display markers set using [ Marker Settings] on the monitor or the viewfinder while shooting movies.

1 MENU →  2 (Camera Settings2) → [ Marker Display] → desired setting.

### Menu item details

**On:**

Markers are displayed. The markers are not recorded.

**Off:**

No marker is displayed.

**Note**

- The markers are displayed when the mode dial is set to  (Movie) or **S&Q**, or when shooting movies.
- You cannot display markers when using [Focus Magnifier].
- The markers are displayed on the monitor or viewfinder. (You cannot output the markers.)

---

### Related Topic



- [Marker Settings \(movie\)](#)

Interchangeable Lens Digital Camera  
ILCE-7M3 α7III

## Marker Settings (movie)

---

Sets the markers to be displayed while shooting movies.

1 MENU →  2 (Camera Settings2) → [ Marker Settings] → desired setting.

### Menu item details

**Center:**

Sets whether or not to display the center marker in the center of the shooting screen.

[Off]/[On]

**Aspect:**

Sets the aspect marker display.

[Off]/[4:3]/[13:9]/[14:9]/[15:9]/[1.66:1]/[1.85:1]/[2.35:1]

**Safety Zone:**

Sets the safety zone display. This becomes the standard range that can be received by a general household TV.

[Off]/[80%]/[90%]

**Guideframe:**

Sets whether or not to display the guide frame. You can verify whether the subject is level or perpendicular to the ground.

[Off]/[On]



**Hint**

- You can display several markers at the same time.
- Place the subject on the cross point of the [Guideframe] to make a balanced composition.

Interchangeable Lens Digital Camera  
ILCE-7M3 α7III

## 4K Output Sel. (movie)

You can set how to record movies and perform HDMI output when your camera is connected to 4K-compatible external recording/playback devices, etc.

- 1 Turn the mode dial to  (movie).
- 2 Connect the camera to the desired device via an HDMI cable.
- 3 MENU →  (Setup) → [ 4K Output Sel.] → desired setting.

### Menu item details

#### Memory Card+HDMI:

Simultaneously outputs to the external recording/playback device and records on the camera's memory card.

#### HDMI Only(30p):

Outputs a 4K movie in 30p to the external recording/playback device without recording on the camera's memory card.

#### HDMI Only(24p):

Outputs a 4K movie in 24p to the external recording/playback device without recording on the camera's memory card.

#### HDMI Only(25p)\*:

Outputs a 4K movie in 25p to the external recording/playback device without recording on the camera's memory card.

\* Only when [NTSC/PAL Selector] is set to PAL.

### Note

- This item can be set only when the camera is in movie mode and connected to a 4K-compatible device.
- When [HDMI Only(30p)], [HDMI Only(24p)] or [HDMI Only(25p)] is set, [HDMI Info. Display] will temporarily be set to [Off].
- A 4K movie is not output to the connected 4K-compatible device during slow-motion/quick-motion shooting.
- When [HDMI Only(30p)], [HDMI Only(24p)] or [HDMI Only(25p)] is set, the counter does not move forward (the actual recording time is not counted) while the movie is being recorded on an external recording/playback device.
- When [ File Format] is set to [XAVC S 4K] and the camera is connected via HDMI, the following functions are not available.
  - [Face Priority in AF]
  - [Face Prty in Mlti Mtr]
  - [Center Lock-on AF]

### Related Topic

- [HDMI Settings: REC Control \(movie\)](#)
- [File Format \(movie\)](#)
- [Record Setting \(movie\)](#)
- [HDMI Settings: HDMI Info. Display](#)

Interchangeable Lens Digital Camera  
ILCE-7M3 α7III

## Video Light Mode

---

Sets the illumination setting for the HVL-LBPC LED light (sold separately).

**1** MENU →  2 (Camera Settings2) → [Video Light Mode] → desired setting.

### Menu item details

**Power Link:**

The video light turns on/off in sync with the ON/OFF operation of this camera.

**REC Link:**

The video light turns on/off in sync with movie recording start/stop.

**REC Link&STBY:**

The video light turns on when movie recording starts and dims when not recording (STBY).

**Auto:**

The video light automatically turns on when it is dark.

Interchangeable Lens Digital Camera  
ILCE-7M3 α7III

## Playing back still images

---

Plays back the recorded images.

- 1 Press the  (Playback) button to switch to the playback mode.
- 2 Select the image with the control wheel.
  - Continuously shot images are displayed as one group. To play back the images in the group, press the center of the control wheel.

### Hint

- The product creates an image database file on a memory card to record and play back images. An image that is not registered in the image database file may not be played back correctly. To play back images shot using other devices, register those images to the image database file using MENU →  (Setup) → [Recover Image DB].
- If you play back the images right after continuous shooting, the monitor may display an icon indicating that data is being written/the number of images left to write. During writing, some functions are not available.
- You can also enlarge an image by double-tapping the monitor. In addition, you can drag and move the magnified position on the monitor. Set [Touch Operation] to [On] beforehand.

---

### Related Topic



- [Recover Image DB](#)
- [Selecting which memory card to play back \(Select PB Media\)](#)

## Enlarging an image being played back (Enlarge Image)

Enlarges the image being played back. Use this function to check the focus of the image, etc.

- 1 Display the image you want to enlarge, and then press the  button.**
  - Turn the control wheel to adjust the zoom scale. By rotating the front/rear dial, you can switch to the previous or next image while keeping the same zoom scale.
  - The view will zoom in on the part of the image where the camera focused during shooting. If the focus location information cannot be obtained, the camera will zoom in on the center of the image.
- 2 Select the portion you want to enlarge by pressing the top/bottom/right/left sides of the control wheel.**
- 3 Press the MENU button or the center of the control wheel to exit the playback zoom.**

### Hint

- You can also enlarge an image being played back using MENU.
- You can change the initial magnification and initial position of enlarged images by selecting MENU →  (Playback) → [ Enlarge Init. Mag.] or [ Enlarge Initial Pos.].
- You can also enlarge an image by double-tapping the monitor. In addition, you can drag and move the magnified position on the monitor. Set [Touch Operation] to [On] beforehand.

### Note

- You cannot enlarge movies.

### Related Topic

- [Touch Operation](#)
- [Enlarge Init. Mag.](#)
- [Enlarge Initial Pos.](#)



Interchangeable Lens Digital Camera  
ILCE-7M3 α7III

## Rotating recorded images automatically (Display Rotation)

---

Selects the orientation when playing back recorded images.

1 MENU →  (Playback) → [Display Rotation] → desired setting.

### Menu item details

#### Auto:

When you rotate the camera, the displayed image rotates automatically by detecting the orientation of the camera.

#### Manual:

Images shot vertically are displayed vertically. If you have set the image orientation using the [Rotate] function, the image will be displayed accordingly.

#### Off:

Images are always displayed horizontally.

---

### Related Topic

- [Rotating an image \(Rotate\)](#)

Interchangeable Lens Digital Camera  
ILCE-7M3 α7III

## Rotating an image (Rotate)

---

Rotates a recorded still image counter-clockwise.

**1** Display the image to be rotated, then select MENU →  (Playback) → [Rotate].

**2** Press the center of the control wheel.

The image is rotated counter-clockwise. The image rotates as you press the center.

If you rotate the image once, the image remains rotated even after the product is turned off.

### Note

- You cannot rotate the movies.
- You may not be able to rotate images shot using other products.
- When viewing rotated images on a computer, the images may be displayed in their original orientation depending on the software.

Interchangeable Lens Digital Camera  
ILCE-7M3 α7III

## Enlarge Init. Mag.

---

Sets the initial magnification scale when playing back enlarged images.

1 MENU →  (Playback) → [ Enlarge Init. Mag.] → **desired setting.**

### Menu item details

#### Standard. Mag.:

Displays an image with the standard magnification.

#### Previous Mag.:

Displays an image with the previous magnification. The previous magnification is stored even after exiting the playback zoom mode.

---

### Related Topic

- [Enlarging an image being played back \(Enlarge Image\)](#)
- [Enlarge Initial Pos.](#)

Interchangeable Lens Digital Camera  
ILCE-7M3 α7III

## Enlarge Initial Pos.

---

Sets the initial position when enlarging an image in playback.

**1** MENU →  (Playback) → [ Enlarge Initial Pos.] → **desired setting.**

### Menu item details

**Focused Position:**

Enlarges the image from the point of focus during shooting.

**Center:**

Enlarges the image from the center of the screen.

---

### Related Topic

- [Enlarging an image being played back \(Enlarge Image\)](#)
- [Enlarge Init. Mag.](#)

Interchangeable Lens Digital Camera  
ILCE-7M3 α7III













## Playing back movies

Plays back the recorded movies.

- 1 Press the  (playback) button to switch to playback mode.
- 2 Select the movie to be played back using the control wheel and press the center of the control wheel to start playback.

### Available operations during movie playback

You can perform slow playback and sound volume adjustment, etc. by pressing the down side of the control wheel.

-  : Playback
-  : Pause
-  : Fast-forward
-  : Fast-rewind
-  : Forward slow playback
-  : Reverse slow playback
-  : Next movie file
-  : Previous movie file
-  : Displays the next frame
-  : Displays the previous frame
-  : Photo Capture
-  : Sound volume adjustment
-  : Closes the operation panel

#### Hint

- “Forward slow playback,” “Reverse slow playback,” “Displays the next frame” and “Displays the previous frame” are available during pause.
- Movie files recorded using other products may not be able to be playable on this camera.

#### Related Topic

- [Switching between still images and movies \(View Mode\)](#)
- [Selecting which memory card to play back \(Select PB Media\)](#)

Interchangeable Lens Digital Camera  
ILCE-7M3 α7III

## Volume Settings

---

Sets the sound volume for movie playback.

**1** MENU →  (Setup) → [Volume Settings] → desired setting.

### Adjusting the volume during playback



Press the bottom side of the control wheel while playing back movies to display the operation panel, then adjust the volume. You can adjust the volume while listening to the actual sound.

Interchangeable Lens Digital Camera  
ILCE-7M3 α7III

## Photo Capture

---

Captures a chosen scene in a movie to save as a still image. First shoot a movie, then pause the movie during playback to capture decisive moments that tend to be missed when shooting still images, and save them as still images.

- 1 **Display the movie that you want to capture as a still image.**
  - 2 **MENU →  (Playback) → [Photo Capture].**
  - 3 **Play back the movie and pause it.**
  - 4 **Find the desired scene using forward slow playback, reverse slow playback, displays the next frame, and displays the previous frame, and then stop the movie.**
  - 5 **Press  (Photo Capture) to capture the chosen scene.**  
The scene is saved as a still image.
- 

### Related Topic

- [Shooting movies](#)
- [Playing back movies](#)

Interchangeable Lens Digital Camera  
ILCE-7M3 α7III

## Playing back images on the image index screen (Image Index)

---

You can display multiple images at the same time in playback mode.

- 1 Press the  (Image Index) button while the image is being played back.
- 2 Select the image by pressing the top/bottom/right/left sides of the control wheel or turning the control wheel.

### To change the number of images to be displayed

MENU →  (Playback) → [Image Index] → desired setting.

#### Menu item details

9 Images/25 Images

### To return to single-image playback

Select the desired image and press the center of the control wheel.

### To display a desired image quickly

Select the bar on the left of the image index screen using the control wheel, then press the top/bottom sides of the control wheel. While the bar is being selected, you can display the calendar screen or folder selection screen by pressing the center. In addition, you can switch View Mode by selecting an icon.

---

#### Related Topic

- [Switching between still images and movies \(View Mode\)](#)



Interchangeable Lens Digital Camera  
ILCE-7M3 α7III

## Setting the method for jumping between images (Image Jump Setting)

---

Sets which dial and method to use for jumping between images during playback. You can quickly find protected images or images set with a particular rating.

1 MENU →  (Playback) → [Image Jump Setting] → desired setting.

### Menu item details

#### Select Dial:

Selects the dial to use for jumping between images.

#### Image Jump Method:

Sets the type of images to be played back with Image Jump.

#### Note

- [Image Jump Setting] is available only when [View Mode] is set to [Date View]. If [View Mode] is not set to [Date View], the camera will always play back every image without jumping when you use the dial selected with [Select Dial].
- When you use the Image Jump function, movie files are always skipped.

---

### Related Topic

- [Rating](#)
- [Protecting images \(Protect\)](#)

Interchangeable Lens Digital Camera  
ILCE-7M3 α7III

## Switching between still images and movies (View Mode)

---

Sets the View Mode (image display method).

1 MENU →  (Playback) → [View Mode] → desired setting.

### Menu item details

 **Date View:**

Displays the images by date.

 **Folder View(Still):**

Displays only still images.

 **AVCHD AVCHD View:**

Displays only AVCHD-format movies.

 **XAVC S HD View:**

Displays only XAVC S HD-format movies.

 **XAVC S 4K View:**

Displays only XAVC S 4K-format movies.

Interchangeable Lens Digital Camera  
ILCE-7M3 α7III

## Disp Cont Shoot Grp

Sets whether to display continuously shot images as a group.

1 MENU →  (Playback) → [Disp Cont Shoot Grp] → desired setting.

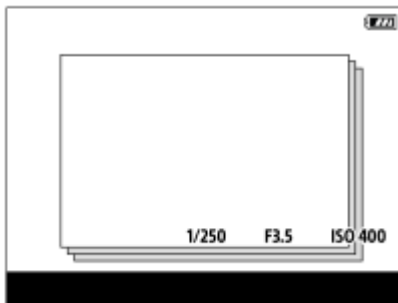

### Menu item details

#### On:

Displays continuously shot images as a group.

#### Off:

Does not display continuously shot images as a group.

#### Hint

- Images shot with [Drive Mode] set to [Cont. Shooting] are grouped. One sequence of images shot continuously by holding down the shutter button during continuous shooting becomes one group.
- On the image index screen,  is displayed over the continuous shooting group.

#### Note

- Images can be grouped and displayed only when [View Mode] is set to [Date View]. When it is not set to [Date View], images cannot be grouped and displayed, even if [Disp Cont Shoot Grp] is set to [On].
- If you delete the continuous shooting group, all the images in the group will be deleted.

### Related Topic

- [Cont. Shooting](#)

Interchangeable Lens Digital Camera  
ILCE-7M3 α7III

## Selecting which memory card to play back (Select PB Media)

---

Selects the memory card slot to be played back.

**1** MENU →  (Playback) → [Select PB Media] → desired slot.

### Menu item details

#### Slot 1:

Selects the slot 1.

#### Slot 2:

Selects the slot 2.

#### Note

- No image is played back when no memory card is inserted in the selected slot. Select a slot into which a memory card has been inserted.
- When you select [Date View] in [View Mode], the camera only plays back images from a memory card selected using [Select PB Media].

---

### Related Topic

- [Switching between still images and movies \(View Mode\)](#)
- [Rec. Media Settings: Prioritize Rec. Media](#)

Interchangeable Lens Digital Camera  
ILCE-7M3 α7III

## Copying images from one memory card to another (Copy)

You can copy images from a memory card in a slot that is selected using [Select PB Media] to a memory card in another slot.

### 1 MENU → (Playback) → [Copy].

All of the contents with a date or in a folder currently being played back will be copied to a memory card in another slot.

#### Hint

- You can select the type of images to be displayed by selecting MENU →  (Playback) → [View Mode].

#### Note

- If images in a continuous shooting group are copied, the copied images will not be displayed as a group on the destination memory card.
- If protected images are copied, the protection will be canceled on the destination memory card.
- It may take a long time when many images are to be copied. Use a sufficiently charged battery pack.
- XAVC S movies can only be copied to a memory card that supports XAVC S movies. A message will be displayed on the monitor of the camera when images cannot be copied.

#### Related Topic

- [Selecting which memory card to play back \(Select PB Media\)](#)
- [Switching between still images and movies \(View Mode\)](#)

Interchangeable Lens Digital Camera  
ILCE-7M3 α7III

## Playing back images using slideshow (Slide Show)

---

Automatically plays back images continuously.

1 MENU →  (Playback) → [Slide Show] → desired setting.

2 Select [Enter].

### Menu item details

#### Repeat:

Select [On], in which images are played back in a continuous loop, or [Off], in which the product exits the slideshow when all the images are played back once.

#### Interval:

Select the display interval for images from among [1 Sec], [3 Sec], [5 Sec], [10 Sec] or [30 Sec].

### To quit the slideshow in the middle of playback

Press the MENU button to quit the slideshow. You cannot pause the slideshow.

#### Hint

- During playback, you can display the next/previous image by pressing the right/left side of the control wheel.
- You can activate a slideshow only when [View Mode] is set to [Date View] or [Folder View(Still)].

## Protecting images (Protect)



Protects recorded images against accidental erasure. The  mark is displayed on protected images.

1 MENU →  (Playback) → [Protect] → desired setting.

### Menu item details

#### Multiple Img.:

Applies or cancels the protection of the selected multiple images.

(1) Select the image to be protected, then press the center of the control wheel. The  mark is displayed in the check box. To cancel the selection, press the center again to remove the  mark.

(2) To protect other images, repeat step (1).

(3) MENU → [OK].

#### All in this Folder:

Protects all images in the selected folder.

#### All with this date:

Protects all images in the selected date range.

#### Cancel All in this Folder:

Cancels the protection of all images in the selected folder.

#### Cancel All with this date:

Cancels the protection of all images in the selected date range.

#### All in Cont. Shoot Grp:

Protects all the images in the selected continuous shooting group.

#### Cancel All in Cnt Sht Grp:

Cancels the protection of all the images in the selected continuous shooting group.

#### Hint

- The [Protect] function is assigned to the C3 button in the default settings.
- If you select a continuous shooting group in [Multiple Img.], all the images in the group will be protected. To select and protect particular images within the group, execute [Multiple Img.] while displaying the images within the group.

#### Note

- The menu items that can be selected vary according to the [View Mode] setting and the selected content.

Interchangeable Lens Digital Camera  
ILCE-7M3 α7III

## Rating

You can assign ratings to recorded images on a scale from ★ to ★★★ to make it easier to find images. Combining this function with [Image Jump Setting] allows you to find a desired image quickly.

- 1 MENU →  (Playback) → [Rating].**  
The image rating selection screen will appear.
- 2 Press the left/right sides of the control wheel to display an image to which you want to assign a rating, and then press the center.**
- 3 Select the number of ★ (Rating) by pressing the left/right sides of the control wheel, and then press the center.**
- 4 Press the MENU button to exit the rating setting screen.**

### Hint

- You can also assign ratings when playing back images by using the custom key. Assign [Rating] to the desired key using [ Custom Key] beforehand, and then press the custom key while playing back an image to which you want to assign a rating. The number of ★ (Rating) changes each time you press the custom key.

### Note

- You can assign ratings to still images only.

### Related Topic

- [Custom Key \(still image/movie/playback\)](#)
- [Rating Set\(Cust Key\)](#)
- [Setting the method for jumping between images \(Image Jump Setting\)](#)



Interchangeable Lens Digital Camera  
ILCE-7M3 α7III

## Rating Set(Cust Key)

---

Sets the available number of ★ when rating images with the key to which you have assigned [Rating] using [  Custom Key].

**1** MENU →  (Playback) → [Rating Set(Cust Key)].

**2** Add a ✓ mark to the number of ★ that you want to activate.

You can select the checked number when setting [Rating] using the custom key.

---

### Related Topic

- [Rating](#)
- [Custom Key \(still image/movie/playback\)](#)

Interchangeable Lens Digital Camera  
ILCE-7M3 α7III

## Specifying images to be printed (Specify Printing)



You can specify in advance on the memory card which still images you want to print out later. The **DPOF** (print order) icon will appear on the specified images. DPOF refers to “Digital Print Order Format.” DPOF setting will be retained after the image is printed. We recommend that you cancel this setting after printing.

1 MENU →  (Playback) → [Specify Printing] → desired setting.

### Menu item details

#### Multiple Img.:

Selects images to order printing.

(1) Select an image and press the center of the control wheel. The  mark is displayed in the check box. To cancel the selection, press the center again and delete the  mark.

(2) Repeat step (1) to print other images. To select all the images from a certain date or in a certain folder, select the check box for the date or folder.

(3) MENU → [OK].

#### Cancel All:

Clears all DPOF marks.

#### Print Setting:

Sets whether to print the date on images registered with DPOF marks.

- The position or size of the date (inside or outside of the image) may differ depending on the printer.

#### Note

- You cannot add the DPOF mark to the following files:
  - RAW images
- The number of copies cannot be specified.
- Some printers do not support the date print function.

Interchangeable Lens Digital Camera  
ILCE-7M3 α7III

## Deleting a displayed image

---

You can delete an image displayed. Once you have deleted an image, you cannot restore it. Confirm the image to be deleted beforehand.

- 1 Display the image you want to delete.
- 2 Press the  (Delete) button.
- 3 Select [Delete] using the control wheel.

### Note

- The protected images cannot be deleted.

---

### Related Topic

- [Deleting multiple selected images \(Delete\)](#)

Interchangeable Lens Digital Camera  
ILCE-7M3 α7III

## Deleting multiple selected images (Delete)



You can delete multiple selected images. Once you have deleted an image, you cannot restore it. Confirm the image to be deleted beforehand.

- 1 MENU →  (Playback) → [Delete] → desired setting.

### Menu item details

#### Multiple Img.:

Deletes the selected images.

(1) Select the images to be deleted, then press the center of the control wheel. The  mark is displayed in the check box. To cancel the selection, press the center again to remove the  mark.

(2) To delete other images, repeat step (1).

(3) MENU → [OK].

#### All in this Folder:

Deletes all images in the selected folder.

#### All with this date:

Deletes all images in the selected date range.

#### All Other Than This Img.:

Deletes all images in the continuous shooting group except the selection.

#### All in Cont. Shoot Grp:

Deletes all images in the selected continuous shooting group.

### Hint

- Perform [Format] to delete all images, including protected images.
- To display the desired folder or date, select the desired folder or date during playback by performing the following procedure:  
 (Image Index) button → select the bar on the left using the control wheel → select the desired folder or date using the top/bottom sides of the control wheel.
- If you select a continuous shooting group in [Multiple Img.], all the images in the group will be deleted. To select and delete particular images within the group, execute [Multiple Img.] while displaying the images within the group.

### Note

- The protected images cannot be deleted.
- The menu items that can be selected vary according to the [View Mode] setting and the selected content.

### Related Topic

- [Deleting a displayed image](#)
- [Format](#)

Interchangeable Lens Digital Camera  
ILCE-7M3 α7III

## Delete confirm.

---

You can set whether [Delete] or [Cancel] is selected as a default on the delete confirmation screen.

**1** MENU →  (Setup) → [Delete confirm.] → desired setting.

### Menu item details

**"Delete" first:**

[Delete] is selected as the default setting.

**"Cancel" first:**

[Cancel] is selected as the default setting.

Interchangeable Lens Digital Camera  
ILCE-7M3 α7III

## Viewing images on a TV using an HDMI cable

To view images stored on this product using a TV, an HDMI cable (sold separately) and an HD TV equipped with an HDMI jack are required.

- 1 Turn off both this product and the TV.
- 2 Connect the HDMI micro terminal of this product to the HDMI jack of the TV using an HDMI cable (sold separately).

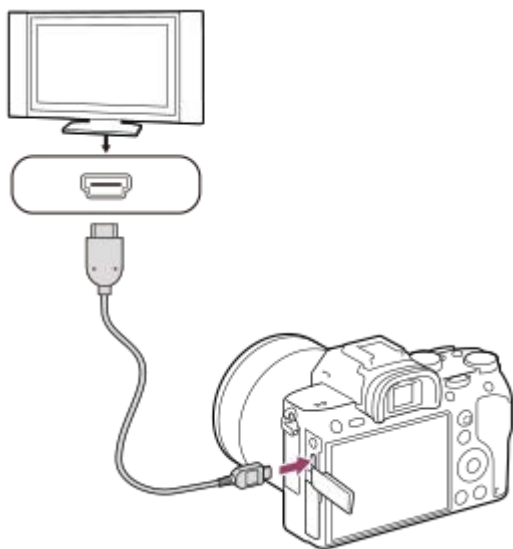

- 3 Turn on the TV and switch the input.
- 4 Turn on this product.  
Images shot with the product appear on the TV screen.
- 5 Select an image using the right/left sides of the control wheel.
  - The monitor of this camera is not lit up on the playback screen.
  - If the playback screen is not displayed, press the  (Playback) button.

### “BRAVIA” Sync

By connecting this product to a TV that supports “BRAVIA” Sync using an HDMI cable (sold separately), you can operate this product’s playback functions with the TV remote control.







1. After performing the steps above to connect this camera to a TV, select MENU →  (Setup) → [HDMI Settings] → [CTRL FOR HDMI] → [On].
2. Press the SYNC MENU button on the TV remote control, and select the desired mode.
  - If you connect this camera to a TV using an HDMI cable, available menu items are limited.
  - Only TVs that support “BRAVIA” Sync can provide SYNC MENU operations. For details, refer to the operating instructions supplied with the TV.

- If the product performs unwanted operations in response to the TV remote control when the product is connected to another manufacturer's TV using an HDMI connection, select MENU →  (Setup) → [HDMI Settings] → [CTRL FOR HDMI] → [Off].

### Hint

- This product is compatible with the PhotoTV HD standard. If you connect Sony PhotoTV HD-compatible devices using an HDMI cable (sold separately), the TV is set to the image quality suitable for viewing still images, and a whole new world of photos can be enjoyed in breathtaking high quality.
- You can connect this product to Sony PhotoTV HD-compatible devices with a USB terminal using the USB cable.
- The PhotoTV HD allows for a highly-detailed, photo-like expression of subtle textures and colors.
- For details, refer to the operating instructions supplied with the compatible TV.



### Note

- Do not connect this product and another device using the output terminals of both. Doing so may cause a malfunction.
- Some devices may not work properly when connected to this product. For example, they may not output video or audio.
- Use an HDMI cable with the HDMI logo or a genuine Sony cable.
- Use an HDMI cable that is compatible with the HDMI micro terminal of the product and the HDMI jack of the TV.
- When [ TC Output] is set to [On], the image may not be output properly to the TV or recording device. In such cases, set [ TC Output] to [Off].
- If images do not appear on the TV screen properly, select MENU →  (Setup) → [HDMI Settings] → [HDMI Resolution] → [2160p/1080p], [1080p] or [1080i] according to the TV to be connected.
- During HDMI output, when you switch the movie from 4K to HD image quality or vice-versa, or change the movie to a different frame rate or different color mode, the screen may become dark. This is not a malfunction.
- If you set [ File Format] to [XAVC S 4K] and shoot movies while the camera is connected to an HDMI device, images will not be displayed on the monitor.
- When [NTSC/PAL Selector] is set to PAL, the screen may black out for an instant in the following situations. This is not a malfunction.
  - When you start or stop recording movies while the shooting mode is set to a mode other than  (Movie) or **S&Q**.
  - When you change the shooting mode from  (Movie) or **S&Q** to another mode.
  - When you play back a movie for the first time after switching to the playback mode.

Interchangeable Lens Digital Camera  
ILCE-7M3 α7III

## Memory (Camera Settings1/Camera Settings2)

Allows you to register up to 2 often-used modes or product settings to the product and up to 4 (M1 through M4) to the memory card. You can recall the settings using just the mode dial.

- 1 Set the product to the setting you want to register.
- 2 MENU →  1 (Camera Settings1) → [   1 /  2 Memory ] → desired number.
- 3 Press the center of the control wheel to confirm.

### Items that can be registered

- You can register various functions for shooting. The items that can actually be registered are displayed on the menu of the camera.
- Aperture (F number)
- Shutter speed

### To change registered settings

Change the setting to the desired one and re-register the setting to the same mode number.

#### Note

- M1 through M4 can be selected only when a memory card is inserted into the product.
- When registering the settings on a memory card, only a memory card that has been selected using [  Select Media ] can be used.
- Program Shift cannot be registered.

### Related Topic

- [Recall \(Camera Settings1/Camera Settings2\)](#)



Interchangeable Lens Digital Camera  
ILCE-7M3 α7III

## Select Media (Memory recall)

---

Selects the memory card slot from which settings are recalled or to which settings are registered for M1 through M4.

**1** MENU →  1 (Camera Settings1) → [ **MR** Select Media ] → desired slot.

### Menu item details

**Slot 1:**

Selects the slot 1.

**Slot 2:**

Selects the slot 2.

Interchangeable Lens Digital Camera  
ILCE-7M3 α7III

## Registering shooting settings to a custom key (Reg Cust Shoot Set)

You can register shooting settings (such as exposure, focus setting, drive mode, etc.) to a custom key in advance and temporarily recall them while holding down the key. Simply press the custom key to switch the settings quickly and release the key to go back to the original settings. This function is useful when recording active scenes such as sports.

- 1 MENU →  1 (Camera Settings1) → [Reg Cust Shoot Set] → Select a registration number from [Recall Custom hold 1] to [Recall Custom hold 3].**

The setting screen for the selected number will be displayed.

- 2 Using the top/bottom/left/right side of the control wheel, select the check boxes for the functions that you want to recall with one of the registration numbers and press the center to check each box.**

A  mark will be displayed in the boxes for the functions.

- To cancel a selection, press the center again.

- 3 Select the function that you want to adjust using the top/bottom/left/right side of the control wheel, and press the center to adjust the function to the desired setting.**



- Select [Import Current Setting] to register the current settings of the camera to the registration number that you chose.

- 4 Select [Register].**

### Items that can be registered

- You can register various functions for shooting. The items that can actually be registered are displayed on the menu of the camera.
- Exposure
- Focus setting
- Drive mode (other than self-timer)

### To recall registered settings

1. MENU →  2 (Camera Settings2) → [ Custom Key] → Select the desired key and then select one of the registration numbers from [Recall Custom hold 1] to [Recall Custom hold 3].
2. On the shooting screen, press the shutter button while holding down the key to which you assigned one of the registration numbers.  
The registered settings are activated while you are holding down the custom key.

#### Hint

- You can change the settings for [Reg Cust Shoot Set] after assigning one of the registration numbers to the custom key using [ Custom Key].

#### Note

- The registration numbers [Recall Custom hold 1] through [Recall Custom hold 3] are available only when the shooting mode is set to P/A/S/M.
- Depending on the attached lens and the status of the camera when the registered setting recall is executed, the registered settings may not take effect.

---

---

## Related Topic

- [Custom Key \(still image/movie/playback\)](#)

4-732-947-11(1) Copyright 2018 Sony Corporation

## Custom Key (still image/movie/playback)

You can assign a desired function to a desired key.

Some functions are available only when they are assigned to a custom key. For example, if you assign [Eye AF] to [Center Button] for [📷 Custom Key], you can easily recall [Eye AF] simply by pressing the center of the control wheel while shooting.

**1** MENU → 📷 2 (Camera Settings2) → [📷 Custom Key], [📺 Custom Key] or [▶ Custom Key].

**2** Select the key to which you want to assign the function on the selection screen, and press the center of the control wheel.

- The keys that can be assigned functions are different for [📷 Custom Key], [📺 Custom Key] and [▶ Custom Key].
- You can assign the desired functions to the following keys.

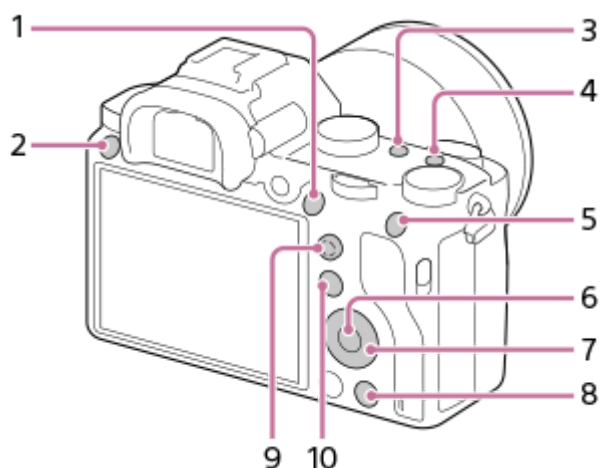

1. AF-ON Button
2. Custom Button 3
3. Custom Button 2
4. Custom Button 1
5. AEL Button
6. Center Button
7. Control Wheel/Down Button/Left Button/Right Button
8. Custom Button 4
9. Multi-Slc Center Btn
10. Fn/📷 Button

- You can also assign a shooting function to the focus hold button on the lens. However, some lenses do not have a focus hold button.

**3** Select the function to be assigned.

- The functions that can be assigned differ depending on the keys.

 **Custom Key:**

Sets the custom key function to use when shooting still images.

 **Custom Key:**

Sets the custom key function to use when recording movies. You can assign a different function from the one used when shooting still images.

 **Custom Key:**

Sets the custom key function to use when playing back images.

---

**Related Topic**

- [Using the control wheel](#)
- [Using the multi-selector](#)
- [Focus Standard](#)

Interchangeable Lens Digital Camera  
ILCE-7M3 α7III

## Function Menu Set.

---

You can assign the functions to be called up when you press the Fn (Function) button.

- 1 **MENU** →  **2 (Camera Settings2)** → **[Function Menu Set.]** → **set a function to the desired location.**
  - The functions that can be assigned are displayed on the setup item selection screen.

Interchangeable Lens Digital Camera  
ILCE-7M3 α7III

## Dial Setup

---

You can switch the functions of the front/rear dial.

1 MENU →  2 (Camera Settings2) → [Dial Setup] → desired setting.

### Menu item details

 Tv  Av:

The front dial is used to change the shutter speed and the rear dial to change the aperture value.

 Av  Tv:

The front dial is used to change the aperture value and the rear dial to change the shutter speed.

#### Note

- The [Dial Setup] function is enabled when the shooting mode is set to "M."

Interchangeable Lens Digital Camera  
ILCE-7M3 α7III

## Av/Tv Rotate

---

Sets the direction of rotation for the front dial, rear dial, or control wheel when changing the aperture value or shutter speed.

**1** MENU →  **2** (Camera Settings2) → [Av/Tv Rotate] → desired setting.

### Menu item details

**Normal:**

Does not change the direction of rotation for the front dial, rear dial, or control wheel.

**Reverse:**

Reverses the direction of rotation for the front dial, rear dial, or control wheel.



Interchangeable Lens Digital Camera  
ILCE-7M3 α7III

## Lock Operation Parts

You can set whether the multi-selector, dials, and wheel can be locked by pressing and holding down the Fn (Function) button.

1 MENU →  2 (Camera Settings2) → [Lock Operation Parts] → desired setting.

- To lock the operating parts, hold down the Fn (function) button until the message “Locked.” appears on the monitor.

### Menu item details

**Off:**  
Does not lock the multi-selector, front dial, rear dial, or control wheel even if you press and hold down the Fn (Function) button.

**Multi-Selector Only:**  
Locks the multi-selector.

**Dial + Wheel:**  
Locks the front dial, rear dial, and control wheel.

**All:**  
Locks the multi-selector, front dial, rear dial, and control wheel.

#### Hint

- You can release the lock by holding the Fn (Function) button down again.

#### Note

- If you set [ AF Area Regist.] to [On], [Lock Operation Parts] will be fixed to [Off].

### Related Topic

- [Registering the current focus area \(AF Area Regist.\) \(still image\)](#)

Interchangeable Lens Digital Camera  
ILCE-7M3 α7III

## Add Item

---

You can register the desired menu items to ★ (My Menu) under MENU.

- 1 MENU → ★ (My Menu) → [Add Item].
- 2 Select an item that you want to add to ★ (My Menu) using the top/bottom/left/right sides of the control wheel.
- 3 Select a destination using the top/bottom/left/right sides of the control wheel.

### Hint

- You can add up to 30 items to ★ (My Menu).

### Note

- You cannot add the following items to ★ (My Menu).
  - Any item under MENU →  (Playback)
  - [View on TV]

---

### Related Topic

- [Sort Item](#)
- [Delete Item](#)
- [Using MENU items](#)

Interchangeable Lens Digital Camera  
ILCE-7M3 α7III

## Sort Item

---

You can rearrange the menu items added to ★ (My Menu) under MENU.

- 1 MENU → ★ (My Menu) → [Sort Item].
  - 2 Select an item that you want to move using the top/bottom/left/right sides of the control wheel.
  - 3 Select a destination using the top/bottom/left/right sides of the control wheel.
- 

### Related Topic

- [Add Item](#)

Interchangeable Lens Digital Camera  
ILCE-7M3 α7III

## Delete Item

---

You can delete menu items added to ★ (My Menu) of MENU.

- 1 MENU → ★ (My Menu) → [Delete Item].
- 2 Select an item that you want to delete using the top/bottom/left/right sides of the control wheel, and then press the center to delete the selected item.

### Hint

- To delete all the items on a page, select MENU → ★ (My Menu) → [Delete Page].
- You can delete all the items added to ★ (My Menu) by selecting MENU → ★ (My Menu) → [Delete All].

---

### Related Topic

- [Delete Page](#)
- [Delete All](#)
- [Add Item](#)

Interchangeable Lens Digital Camera  
ILCE-7M3 α7III

## Delete Page

---

You can delete all the menu items added to a page under ★ (My Menu) in MENU.

**1** MENU → ★ (My Menu) → [Delete Page].

**2** Select a page that you want to delete using the left/right sides of the control wheel, and then press the center of the control wheel to delete the items.

---

### Related Topic

- [Add Item](#)
- [Delete All](#)

Interchangeable Lens Digital Camera  
ILCE-7M3 α7III

## Delete All

---

You can delete all the menu items added to ★ (My Menu) in MENU.

- 1 MENU → ★ (My Menu) → [Delete All].
  - 2 Select [OK].
- 

### Related Topic

- [Add Item](#)
- [Delete Page](#)

Interchangeable Lens Digital Camera  
ILCE-7M3 α7III

## Auto Review

---

You can check the recorded image on the screen right after the shooting. You can also set the display time for Auto Review.

1 MENU →  2 (Camera Settings2) → [Auto Review] → desired setting.

### Menu item details

#### 10 Sec/5 Sec/2 Sec:

Displays the recorded image on the screen right after shooting for the selected duration of time. If you perform a magnifying operation during Auto Review, you can check that image using the magnified scale.

#### Off:

Does not display the Auto Review.

#### Note

- When you use a function that performs image processing, the image before processing may be displayed temporarily, followed by the image after processing.
- The DISP (Display Setting) settings are applied for the Auto Review display.

---

### Related Topic



- [Enlarging an image being played back \(Enlarge Image\)](#)

Interchangeable Lens Digital Camera  
ILCE-7M3 α7III

## Aperture Preview

---

While you press and hold the key to which you assigned the [Aperture Preview] function, the aperture is stepped down to the set aperture value and you can check the blurriness prior to shooting.

1 MENU →  2 (Camera Settings2) → [ Custom Key] → set the [Aperture Preview] function to the desired key.

2 Confirm the image by pressing the key to which [Aperture Preview] was assigned.

### Hint

- Although you can change the aperture value during the preview, the subject may be defocused if you select a brighter aperture. We recommend that you adjust the focus again.

---

### Related Topic

- [Custom Key \(still image/movie/playback\)](#)
- [Shot. Result Preview](#)





Interchangeable Lens Digital Camera  
ILCE-7M3 α7III

## Shot. Result Preview

---

While pressing down the key to which [Shot. Result Preview] is assigned, you can check the image preview with the DRO, shutter speed, aperture and ISO sensitivity settings applied. Check the shooting result preview before shooting.

- 1 MENU →  2 (Camera Settings2) → [ Custom Key] → set the [Shot. Result Preview] function to the desired key.
- 2 Confirm the image by pressing the key to which [Shot. Result Preview] was assigned.

### Hint

- The DRO settings, shutter speed, aperture and ISO sensitivity settings you have set are reflected on the image for [Shot. Result Preview], but some effects cannot be previewed depending on the shooting settings. Even in that case, the settings you have selected will be applied to the images you shoot.

---

### Related Topic

- [Custom Key \(still image/movie/playback\)](#)
- [Aperture Preview](#)

Interchangeable Lens Digital Camera  
ILCE-7M3 α7III

## Live View Display

Sets whether or not to show images altered with effects of the exposure compensation, white balance, [Creative Style], or [Picture Effect] on the screen.

1 MENU →  2 (Camera Settings2) → [Live View Display] → desired setting.

### Menu item details

#### Setting Effect ON:

Displays Live View in conditions close to what your picture will look like as a result of applying all your settings. This setting is useful when you want to shoot pictures while checking the results of the shot on the Live View screen.

#### Setting Effect OFF:

Displays Live View without the effects of exposure compensation, white balance, [Creative Style], or [Picture Effect]. When this setting is used, you can easily check the image composition.

Live View is always displayed with the appropriate brightness even in [Manual Exposure] mode.

When [Setting Effect OFF] is selected, the **VIEW** icon is displayed on the Live View screen.

#### Hint

- When you use a third-party flash, such as a studio flash, Live View Display may be dark for some shutter speed settings. When [Live View Display] is set to [Setting Effect OFF], Live View Display will be displayed brightly, so that you can easily check the composition.

#### Note

- [Live View Display] cannot be set to [Setting Effect OFF] in the following shooting modes:
  - [Intelligent Auto]
  - [Movie]
  - [S&Q Motion]
  - [Scene Selection]
- When [Live View Display] is set to [Setting Effect OFF], the brightness of the shot image will not be the same as that of the displayed Live View.

Interchangeable Lens Digital Camera  
ILCE-7M3 α7III

## Grid Line

---

Sets whether the grid line is displayed or not. The grid line will help you to adjust the composition of images.

**1** MENU →  2 (Camera Settings2) → [Grid Line] → desired setting.

### Menu item details

#### Rule of 3rds Grid:

Place main subjects close to one of the grid lines that divide the image into thirds for a well-balanced composition.

#### Square Grid:

Square grids make it easier to confirm the horizontal level of your composition. This is suitable to determine the quality of the composition when shooting landscape, close-up, or duplicated images.

#### Diag. + Square Grid:

Place a subject on the diagonal line to express an uplifting and powerful feeling.

#### Off:

Does not display the grid line.

Interchangeable Lens Digital Camera  
ILCE-7M3 α7III

## FINDER/MONITOR

Sets the method for switching the display between Electronic Viewfinder and the screen.

1 MENU →  2 (Camera Settings2) → [FINDER/MONITOR] → desired setting.

### Menu item details

#### Auto:

When you look into the Electronic Viewfinder, the eye sensor reacts and the display is switched to the Electronic Viewfinder automatically.





#### Viewfinder(Manual):

The screen is turned off and the image is displayed only in the Electronic Viewfinder.

#### Monitor(Manual):

The Electronic Viewfinder is turned off and the image is always displayed on the screen.

#### Hint

- You can assign the [FINDER/MONITOR] function to your preferred key.  
MENU →  2 (Camera Settings2) → [ Custom Key], [ Custom Key] or [ Custom Key] → set [Finder/Monitor Sel.] to the preferred key.
- If you want to retain the Electronic Viewfinder display or the monitor display, set [FINDER/MONITOR] to [Viewfinder(Manual)] or [Monitor(Manual)] beforehand.  
You can keep the monitor off when you take your eyes off the Electronic Viewfinder during recording by setting the monitor display to [Monitor Off] using the DISP button. Select MENU →  2 (Camera Settings2) → [DISP Button] → [Monitor] and add a check mark to [Monitor Off] beforehand.

#### Note

- When the monitor is pulled out, the eye sensor of the camera will not detect your eye approaching even if [FINDER/MONITOR] is set to [Auto]. The image will continue to be displayed on the monitor.

### Related Topic

- [Custom Key \(still image/movie/playback\)](#)
- [DISP Button \(Monitor/Finder\)](#)

Interchangeable Lens Digital Camera  
ILCE-7M3 α7III

## Monitor Brightness

---

Adjust the brightness of the screen.

**1** MENU →  (Setup) → [Monitor Brightness] → desired setting.

### Menu item details

**Manual:**

Adjusts the brightness within the range of -2 to +2.

**Sunny Weather:**

Sets the brightness appropriately for shooting outdoors.

**Note**

- The [Sunny Weather] setting is too bright for shooting indoors. Set [Monitor Brightness] to [Manual] for indoor shooting.

Interchangeable Lens Digital Camera  
ILCE-7M3 α7III

## Viewfinder Bright.

---

When using an electronic viewfinder, this product adjusts the brightness of the electronic viewfinder according to the surrounding environment.

**1** MENU →  (Setup) → [Viewfinder Bright.] → desired setting.

### Menu item details

**Auto:**

Adjusts the brightness automatically.

**Manual:**

Selects the brightness of the electronic viewfinder within the range of -2 to +2.

Interchangeable Lens Digital Camera  
ILCE-7M3 α7III

## Finder Color Temp.

---

Adjusts the color temperature of the electronic viewfinder.

**1** MENU →  (Setup) → [Finder Color Temp.] → desired setting.

### Menu item details

#### **-2 to +2:**

When you select “-,” the viewfinder screen changes to a warmer color, and when you select “+,” it changes to a colder color.

Interchangeable Lens Digital Camera  
ILCE-7M3 α7III

## Display Quality

---

You can change the display quality.

**1** MENU →  (Setup) → [Display Quality] → desired setting.

### Menu item details

**High:**

Displays in high quality.

**Standard:**

Displays in standard quality.

**Note**



- When [High] is set, battery consumption will be higher than when [Standard] is set.
- When the temperature of the camera rises, the setting may become locked to [Standard].



Interchangeable Lens Digital Camera  
ILCE-7M3 α7III

## Bright Monitoring

Allows you to adjust the composition when shooting in dark environments. By extending the exposure time, you can check the composition on the viewfinder/monitor even in dark locations such as under the night sky.

- 1 MENU →  2 (Camera Settings2) → [ Custom Key] → assign the [Bright Monitoring] function to the desired key.
- 2 Press the key to which you assigned the [Bright Monitoring] function, then shoot an image.
  - The brightness due to [Bright Monitoring] will continue after shooting.
  - To return the monitor brightness to normal, press the key to which you assigned the [Bright Monitoring] function once again.

### Note

- During [Bright Monitoring], [Live View Display] will automatically switch to [Setting Effect OFF], and setting values such as exposure compensation will not be reflected in the live view display. It is recommended that you use [Bright Monitoring] only in dark locations.
- [Bright Monitoring] will be automatically cancelled in the following situations.
  - When the camera is turned off.
  - When the shooting mode is changed from P/A/S/M to a mode that is not P/A/S/M.
  - When the focus mode is set to other than manual focus.
  - When [ MF Assist] is executed.
  - When [Focus Magnifier] is selected.
  - When [Focus Settings] is selected.
- During [Bright Monitoring], the shutter speed may be slower than normal while shooting in dark locations. Also, because the measured brightness range is expanded, the exposure may change.

### Related Topic

- [Live View Display](#)

Interchangeable Lens Digital Camera  
ILCE-7M3 α7III

## Format

---

When you use a memory card with this camera for the first time, we recommend that you format the card using the camera for stable performance of the memory card. Note that formatting permanently erases all data on the memory card, and is unrecoverable. Save valuable data on a computer, etc.

**1** MENU →  (Setup) → [Format] → desired memory card slot.

### Note

- Formatting permanently erases all data including protected images and registered settings (from M1 to M4).
- The access lamp lights up during formatting. Do not remove the memory card while the access lamp is lit up.
- Format the memory card on this camera. If you format the memory card on the computer, the memory card may not be usable depending on the format type.
- It may take a few minutes to complete formatting, depending on the memory card.
- You cannot format the memory card if the remaining battery charge is less than 1%.

Interchangeable Lens Digital Camera  
ILCE-7M3 α7III

## File Number

---

Selects how to assign file numbers to still images.

1 MENU →  (Setup) → [File Number] → desired setting.

### Menu item details

#### Series:

The product will assign numbers to files sequentially up to "9999" without resetting.

#### Reset:

The product resets numbers when a file is recorded in a new folder and assigns numbers to files starting with "0001".  
(When the recording folder contains a file, a number one higher than the largest number is assigned.)

#### Hint

- The setting for [File Number] will be applied to both slot 1 and slot 2.
- Even if you change the setting of [Prioritize Rec. Media], the file numbers will be sequential across the two memory cards in each slot by setting [File Number] to [Series].

Interchangeable Lens Digital Camera  
ILCE-7M3 α7III

## Set File Name

---

You can specify the first three characters of the file name for images you shoot.

- 1 MENU →  (Setup) → [Set File Name].
- 2 Select the entry field for the file name to display a keyboard on the screen, and then enter three characters of your choice.
  - The setting for [Set File Name] will be applied to both slot 1 and slot 2.

### Note

- Only capital letters, numbers, and underscores can be entered. However, an underscore cannot be used as the first character.
- The three characters of the file name you specify using [Set File Name] will only be applied to images you shoot after changing the setting.

---

### Related Topic

- [How to use the keyboard](#)

Interchangeable Lens Digital Camera  
ILCE-7M3 α7III

## Display Media Info.

---

Displays the recordable time of movies for the inserted memory card. Also displays the number of recordable still images for the inserted memory card.

**1** MENU →  (Setup) → [Display Media Info.] → desired memory card slot.

Interchangeable Lens Digital Camera  
ILCE-7M3 α7III

## Rec. Media Settings: Prioritize Rec. Media

---

Selects the memory card slot on which to record. [Slot 1] is the default setting. If you do not intend to change the settings and will only use one memory card, use the slot 1.

1 MENU →  (Setup) → [Rec. Media Settings] → [Prioritize Rec. Media] → desired slot.

### Menu item details

#### Slot 1:

Selects media in the slot 1.

#### Slot 2:

Selects media in the slot 2.

#### Hint

- To record the same image on two memory cards at the same time or to sort recorded images onto two memory card slots by the image type (still image/movie), use [Recording Mode].

#### Note

- The slot 2 supports Memory Stick PRO Duo media and SD cards. The slot 1 supports SD cards only.

---

### Related Topic

- [Memory cards that can be used](#)
- [Rec. Media Settings: Recording Mode](#)

Interchangeable Lens Digital Camera  
ILCE-7M3 α7III

## Rec. Media Settings: Recording Mode

You can select the method for recording an image, such as recording the same image simultaneously to two memory cards or recording different types of images to two memory cards.

1 MENU →  (Setup) → [Rec. Media Settings] → [Recording Mode] → desired setting.

### Menu item details

#### Standard:

Records an image to a memory card in the memory card slot that you select in [Prioritize Rec. Media].

#### Simult. ():

Records a still image to both memory cards and records a movie to a memory card in the memory card slot that you select in [Prioritize Rec. Media].

#### Simult. ():

Records a still image to a memory card in the memory card slot that you select in [Prioritize Rec. Media], and records a movie to both memory cards.

#### Simult. ( / ):

Records a still image and a movie to both memory cards.

#### Sort(RAW/JPEG):

Records an image in RAW format to a memory card in the memory card slot that you select in [Prioritize Rec. Media], and records an image in JPEG format to the other memory card. Movies are recorded to the memory card in the memory card slot that you selected in [Prioritize Rec. Media].

#### Sort(JPEG/RAW):

Records an image in JPEG format to a memory card in the memory card slot that you select in [Prioritize Rec. Media], and records an image in RAW format to the other memory card. Movies are recorded to the memory card in the memory card slot that you selected in [Prioritize Rec. Media].

#### Sort( / ):

Records a still image to a memory card in the memory card slot that you select in [Prioritize Rec. Media], and records a movie to the other memory card.

#### Hint

- Even when [Recording Mode] is set to [Sort(RAW/JPEG)] or [Sort(JPEG/RAW)], if [RAW & JPEG] is not selected under [ File Format], only files of the selected format will be recorded.

### Related Topic

- [Memory cards that can be used](#)
- [Rec. Media Settings: Prioritize Rec. Media](#)

## Rec. Media Settings: Auto Switch Media

If a memory card in use becomes full or you have forgotten to insert a memory card into a slot, you can record images to the other memory card.

1 MENU →  (Setup) → [Rec. Media Settings] → [Auto Switch Media] → desired setting.

### Menu item details

**On:**  
The camera automatically starts recording on the other memory card when a memory card in use becomes full or if you have forgotten to insert a memory card.

**Off:**  
The camera does not perform [Auto Switch Media].

### How the camera switches the memory card slot in use

#### When [Recording Mode] is set to [Standard]:

When images cannot be recorded to the memory card in use, [Prioritize Rec. Media] switches automatically and images are recorded to the other memory card.

When the other memory card becomes full after switching, the camera starts recording in the former slot again.

Example: When [Prioritize Rec. Media] is set to [Slot 1]

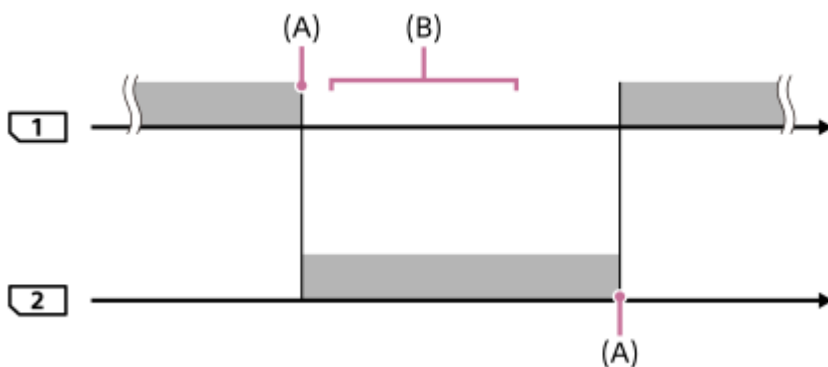



 : Recording images

(A): Recording is no longer possible on the memory card (due to lack of capacity, etc.).

(B): The memory card is replaced with a recordable one.

### When recording the same image simultaneously to two memory cards:



- Recording still images with [Recording Mode] set to [Simult. ()]
- Recording movies with [Recording Mode] set to [Simult. ()]
- Recording still images or movies with [Recording Mode] set to [Simult. ()]

The camera stops simultaneous recording when either of the memory cards becomes full. When you remove the memory card that has become full, the camera starts recording to the other memory card.

When you replace the memory card that has become full with a recordable memory card, the camera starts simultaneous recording with the selected setting again.



Example: When [Prioritize Rec. Media] is set to [Slot 1]

([Recording Mode]: [Simult. (  /  )])

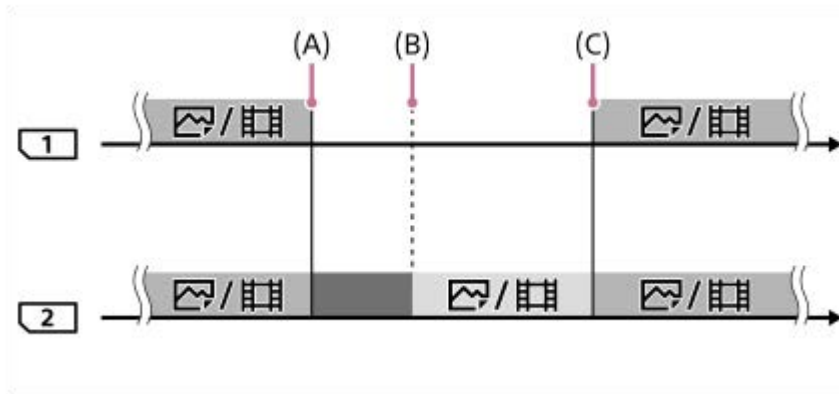

 : Simultaneous recording is available.

 : Recording is disabled.

 : The same image cannot be recorded simultaneously.

(A): Recording is no longer possible on the memory card (due to lack of capacity, etc.).

(B): The memory card is removed.

(C): A recordable memory card is inserted.

- Images that are not recorded simultaneously (for example: still images during [Simult. (  )]) continue to be recorded to the other memory card when the memory card in use becomes full.
- When the memory card in use becomes full while recording a movie, the movie continues to be recorded to the other memory card until the recording in progress is finished.

#### When recording images separately to two memory cards in the RAW and JPEG formats:

- When [Recording Mode] is set to [Sort(RAW/JPEG)] or [Sort(JPEG/RAW)], and [  File Format] is set to [RAW & JPEG]

The camera stops recording when either of the memory cards becomes full. When you remove the memory card that has become full, the camera starts recording both in the RAW and JPEG formats to the other memory card.

When you replace the memory card that has become full with a recordable memory card, the camera starts recording the two types of images separately with the selected setting again.

Example: When [Prioritize Rec. Media] is set to [Slot 1]

([Recording Mode]: [Sort(RAW/JPEG)])

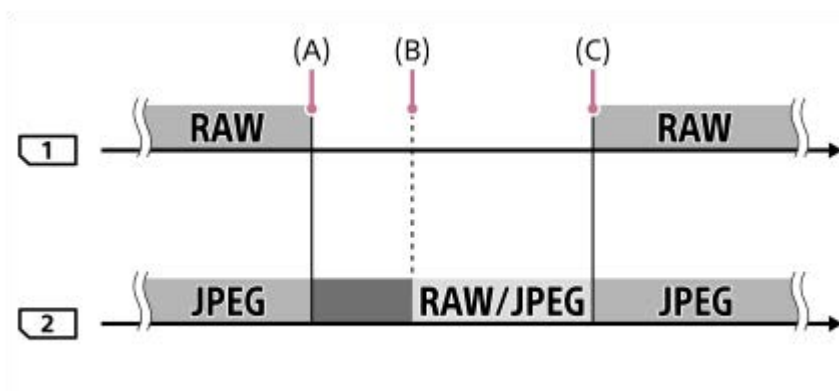

 : Images are sorted by the file format.

 : Recording still images is disabled (movies can be recorded).

 : Images cannot be sorted.

(A): Recording is no longer possible on the memory card (due to lack of capacity, etc.).

(B): The memory card is removed.

(C): A recordable memory card is inserted.

- When the memory card in use becomes full while recording movies, the camera starts recording to the other memory card.

### When recording still images and movies separately to two memory cards:

- When [Recording Mode] is set to [Sort(📷/🎥)]

When either of the memory cards becomes full, both still images and movies are recorded to the other memory card. When you replace the memory card that has become full with a recordable memory card, the camera starts recording the two types of images separately with the selected setting again.

Example: When [Prioritize Rec. Media] is set to [Slot 1]

([Recording Mode]: [Sort(📷/🎥)])

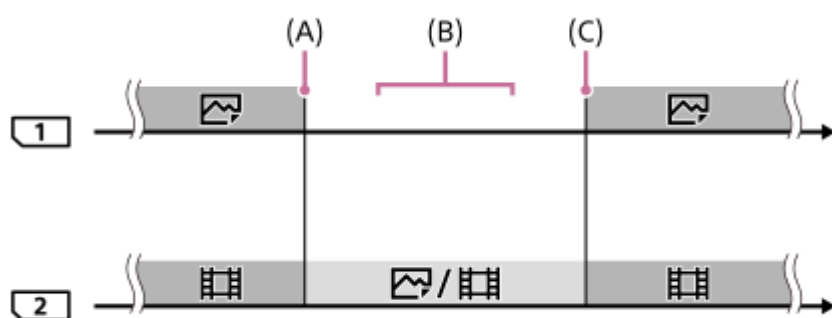

■ : Images are sorted by the image type.

■ : Images cannot be sorted.

(A): Recording is no longer possible on the memory card (due to lack of capacity, etc.).

(B): The memory card is removed.

(C): A recordable memory card is inserted.

#### Hint

- Images are recorded to the memory card in the slot displayed on the monitor with an arrow symbol. After the camera switches the slot using [Auto Switch Media], replace the memory card in the former slot with a recordable memory card.
- If [Recording Mode] is set to [Standard], the setting for [Prioritize Rec. Media] will switch automatically when the slot switches. If you want to record on the slot in use before switching, select the desired slot again using [Prioritize Rec. Media].
- If you want to continually record with the settings selected with [Recording Mode] and [Prioritize Rec. Media], set [Auto Switch Media] to [Off].
- Even when the camera records a movie on two memory cards using [Auto Switch Media], the continuous recordable time is approximately 29 minutes per recording.

#### Related Topic

- [Memory cards that can be used](#)
- [Recordable movie times](#)
- [Rec. Media Settings: Prioritize Rec. Media](#)

Interchangeable Lens Digital Camera  
ILCE-7M3 α7III

## Select REC Folder

---

If [Folder Name] is set to [Standard Form] and there are 2 folders or more, you can select the folder on the memory card to which images are to be recorded.

**1** MENU →  (Setup) → [Select REC Folder] → desired folder.

### Note

- You cannot select the folder when [Folder Name] is set to [Date Form].
- If [Recording Mode] is set to other than [Standard], you may only select the common folder on the both memory cards. If there is no common folder, you can make one using [New Folder].

---

### Related Topic

- [Folder Name](#)
- [Rec. Media Settings: Recording Mode](#)

Interchangeable Lens Digital Camera  
ILCE-7M3 α7III

## New Folder

---

Creates a new folder on the memory card for recording still images. A new folder is created with a folder number one greater than the largest folder number currently used. Images are recorded in the newly created folder.

1 MENU →  (Setup) → [New Folder].

### Note

- When you insert a memory card that was used with other equipment into this product and shoot images, a new folder may be automatically created.
- Up to 4,000 images in total can be stored in one folder. When the folder capacity is exceeded, a new folder may be automatically created.
- If [Recording Mode] is set to other than [Standard], a new folder is created with a folder number one greater than the largest folder number currently used on both memory cards inserted in the memory card slots.
- If [Recording Mode] is set to other than [Standard] and an image is shot, a new folder may be automatically created.

---

### Related Topic

- [Rec. Media Settings: Recording Mode](#)

Interchangeable Lens Digital Camera  
ILCE-7M3 α7III

## Folder Name

---

Still images are recorded in a folder that is automatically created inside the DCIM folder on the memory card. You can change the way folder names are assigned.

1 MENU →  (Setup) → [Folder Name] → desired setting.

### Menu item details

#### Standard Form:

The folder name form is as follows: folder number + MSDCF.

Example: 100MSDCF

#### Date Form:

The folder name form is as follows: folder number + Y (the last digit)/MM/DD.

Example: 10070405 (Folder number: 100, date: 04/05/2017)

#### Note

- You cannot change the [Folder Name] settings for movies.

Interchangeable Lens Digital Camera  
ILCE-7M3 α7III

## Recover Image DB

---

If image files were processed on a computer, problems may occur in the image database file. In such cases, the images on the memory card will not be played back on this product. If these problems happen, repair the file using [Recover Image DB].

**1** MENU →  (Setup) → [Recover Image DB] → desired memory card slot → [Enter].

### Note

- Use a sufficiently charged battery pack. Low battery power during repairing can cause damage to data.

Interchangeable Lens Digital Camera  
ILCE-7M3 α7III

## Audio signals

---

Selects whether the product produces a sound or not.

**1** MENU →  **2** (Camera Settings2) → [Audio signals] → desired setting.

### Menu item details

**On:**

Sounds are produced for example when the focus is achieved by pressing the shutter button halfway down.

**Off:**

Sounds are not produced.

**Note**

- If [Focus Mode] is set to [Continuous AF], the camera will not beep when it focuses on a subject.

Interchangeable Lens Digital Camera  
ILCE-7M3 α7III

## Pwr Save Start Time

---

Sets time intervals to automatically switch to power save mode when you are not performing operations to prevent wearing down the battery pack. To return to shooting mode, perform an operation such as pressing the shutter button halfway down.

1 MENU →  (Setup) → [Pwr Save Start Time] → desired setting.

### Menu item details

30 Min/5 Min/2 Min/1 Min/10 Sec

#### Note

- Turn off the product when you do not use it for a long time.
- The power save function is not activated when power is being supplied via USB, when playing back slideshows, when recording movies, or when connected to a computer or TV.



Interchangeable Lens Digital Camera  
ILCE-7M3 α7III

## Auto Pwr OFF Temp.

Sets the temperature of the camera at which the camera turns off automatically during shooting. When it is set to [High], you can continue shooting even when the temperature of the camera gets hotter than normal.

1 MENU →  (Setup) → [Auto Pwr OFF Temp.] → desired setting.

### Menu item details

#### Standard:

Sets the standard temperature for the camera to turn off.

#### High:

Sets the temperature at which the camera turns off to higher than [Standard].

#### Notes when [Auto Pwr OFF Temp.] is set to [High]

- Do not shoot while holding the camera in your hand. Use a tripod.
- Using the camera while holding it in your hand for a long period of time may cause low-temperature burns.

### Continuous recording time for movies when [Auto Pwr OFF Temp.] is set to [High]

The duration of time available for continuous movie recording is as follows when the camera starts recording with the default settings after the power has been turned off for a while. The following values indicate the continuous time from when the camera starts recording until the camera stops recording.

#### Ambient temperature: 20°C (68°F)

Continuous recording time for movies (HD): Approx. 29 minutes

Continuous recording time for movies (4K): Approx. 29 minutes

#### Ambient temperature: 30°C (86°F)

Continuous recording time for movies (HD): Approx. 29 minutes

Continuous recording time for movies (4K): Approx. 29 minutes

#### Ambient temperature: 40°C (104°F)

Continuous recording time for movies (HD): Approx. 29 minutes

Continuous recording time for movies (4K): Approx. 29 minutes

HD: XAVC S HD (60p 50M/50p 50M, when the camera is not connected via Wi-Fi)

4K: XAVC S 4K (24p 60M/25p 60M, when the camera is not connected via Wi-Fi)

#### Note

- Even if [Auto Pwr OFF Temp.] is set to [High], depending on the conditions or the temperature of the camera, the recordable time for movies may not change.

### Related Topic

- [Recordable movie times](#)

Interchangeable Lens Digital Camera  
ILCE-7M3 α7III

## Remote Ctrl

---

You can operate this product and shoot images using the SHUTTER button, 2SEC button (2 second delay shutter), and START/STOP button (or Movie button (RMT-DSLR2 only)) on the Wireless Remote Commander RMT-DSLR1 (sold separately) and RMT-DSLR2 (sold separately). Refer also to the operating instructions for the Wireless Remote Commander.

1 MENU →  (Setup) → [Remote Ctrl] → desired setting.

### Menu item details

**On:**

Allows remote commander operation.

**Off:**

Does not allow remote commander operation.

**Note**

- The lens or lens hood may block the remote sensor that receive the signals. Use the remote commander in the position from which the signal can reach the product.
- When [Remote Ctrl] is set to [On], the product does not switch to power save mode. Set [Off] after using a remote commander.



Interchangeable Lens Digital Camera  
ILCE-7M3 α7III

## NTSC/PAL Selector

Plays back movies recorded with the product on a NTSC/PAL system TV.

1 MENU →  (Setup) → [NTSC/PAL Selector] → [Enter]

### Note

- If you insert a memory card that has previously been formatted with a different video system, a message telling you that you must reformat the card will appear.  
If you want to record using another system, re-format the memory card or use another memory card.
- When you perform [NTSC/PAL Selector], and the setting is changed from the default one, a message "Running on NTSC." or "Running on PAL." will appear on the start-up screen.
- When [NTSC/PAL Selector] is set to PAL, the viewfinder or monitor of the camera or the screen of an HDMI-connected device may black out for an instant in the following situations. This is not a malfunction.
  - When you start or stop recording movies while the shooting mode is set to a mode other than  (Movie) or **S&Q**.
  - When you change the shooting mode from  (Movie) or **S&Q** to another mode.
  - When you play back a movie for the first time after switching to the playback mode.

Interchangeable Lens Digital Camera  
ILCE-7M3 α7III

## HDMI Settings: HDMI Resolution

When you connect the product to a High Definition (HD) TV with HDMI terminals using an HDMI cable (sold separately), you can select HDMI Resolution to output images to the TV.

1 MENU →  (Setup) → [HDMI Settings] → [HDMI Resolution] → desired setting.

### Menu item details

**Auto:**

The product automatically recognizes an HD TV and sets the output resolution.

**2160p/1080p:**

Outputs signals in 2160p/1080p.

**1080p:**

Outputs signals in HD picture quality (1080p).

**1080i:**

Outputs signals in HD picture quality (1080i).



**Note**

- If the images are not displayed properly using the [Auto] setting, select either [1080i], [1080p] or [2160p/1080p], based on which TV is to be connected.

Interchangeable Lens Digital Camera  
ILCE-7M3 α7III

## HDMI Settings: 24p/60p Output (movie) (Only for 1080 60i compatible models)

You can set 1080/24p or 1080/60p as the HDMI output format when [ Record Setting] is set to [24p 50M], [24p 60M] or [24p 100M].

- 1 MENU →  (Setup) → [HDMI Settings] → [HDMI Resolution] → [1080p].
- 2 MENU →  (Setup) → [HDMI Settings] → [ 24p/60p Output] → desired setting.

### Menu item details

#### 60p:

Movies are output as 60p.

#### 24p:

Movies are output as 24p.

#### Note

- Steps 1 and 2 can be set in either order.

### Related Topic

- [Record Setting \(movie\)](#)

Interchangeable Lens Digital Camera  
ILCE-7M3 α7III

## HDMI Settings: HDMI Info. Display

Selects whether to display the shooting information when this product and the TV are connected using an HDMI cable (sold separately).

1 MENU →  (Setup) → [HDMI Settings] → [HDMI Info. Display] → desired setting.

### Menu item details

#### On:

Displays the shooting information on the TV.

The recorded image and the shooting information are displayed on the TV, while nothing is displayed on the camera's monitor.

#### Off:

Does not display the shooting information on the TV.

Only the recorded image is displayed on the TV, while the recorded image and the shooting information are displayed on the camera's monitor.

#### Note

- When this product is connected to a 4K-compatible TV, [Off] is selected automatically.
- If you set [ File Format] to [XAVC S 4K] and shoot movies while the camera is connected to an HDMI device, images will not be displayed on the monitor.

Interchangeable Lens Digital Camera  
ILCE-7M3 α7III

## HDMI Settings: TC Output (movie)

Sets whether or not to layer the TC (time code) information on the output signal via the HDMI terminal when outputting the signal to other professional-use devices.

This function layers the time code information on the HDMI output signal. The product sends the time code information as digital data, not as an image displayed on the screen. The connected device can then refer to the digital data to recognize the time data.

1 MENU →  (Setup) → [HDMI Settings] → [ TC Output] → desired setting.

### Menu item details



#### On:

Time code is output to other devices.

#### Off:

Time code is not output to other devices.

#### Note

- When [ TC Output] is set to [On], the image may not be output properly to the TV or recording device. In such cases, set [ TC Output] to [Off].

Interchangeable Lens Digital Camera  
ILCE-7M3 α7III

## HDMI Settings: REC Control (movie)

If you connect the camera to an external recorder/player, you can remotely command the recorder/player to start/stop recording using the camera.

1 MENU →  (Setup) → [HDMI Settings] → [ REC Control] → desired setting.

### Menu item details

#### On:







 STBY The camera can send a recording command to an external recorder/player.

 REC The camera is sending a recording command to an external recorder/player.

#### Off:

The camera is not able to send a command to an external recorder/player to start/stop recording.

#### Note

- Available for external recorders/players compatible with [ REC Control].
- When you use the [ REC Control] function, set the shooting mode to  (Movie).
- When [ TC Output] is set to [Off], you cannot use the [ REC Control] function.
- Even when  REC is displayed, the external recorder/player may not work properly depending on the settings or status of the recorder/player. Check if the external recorder/player works properly before use.



Interchangeable Lens Digital Camera  
ILCE-7M3 α7III

## HDMI Settings: CTRL FOR HDMI

When connecting this product to a “BRAVIA” Sync-compatible TV using an HDMI cable (sold separately), you can operate this product by aiming the TV remote control at the TV.

- 1 **MENU** →  (Setup) → [HDMI Settings] → [CTRL FOR HDMI] → **desired setting**.
- 2 **Connect this product to a “BRAVIA” Sync-compatible TV.**  
The input of the TV is switched automatically and images on this product are displayed on the TV screen.
- 3 **Press the SYNC MENU button of the TV’s remote control.**
- 4 **Operate this product using the TV’s remote control.**

### Menu item details

#### On:

You can operate this product with a TV’s remote control.

#### Off:

You cannot operate this product with a TV’s remote control.

#### Note

- If you connect this product to a TV using an HDMI cable, available menu items are limited.
- [CTRL FOR HDMI] is available only with a “BRAVIA” Sync-compatible TV. Also, the SYNC MENU operation differs depending on the TV you are using. For details, refer to the operating instructions supplied with the TV.
- If the product performs unwanted operations in response to the TV remote control when the product is connected to another manufacturer’s TV using an HDMI connection, select MENU →  (Setup) → [HDMI Settings] → [CTRL FOR HDMI] → [Off].

Interchangeable Lens Digital Camera  
ILCE-7M3 α7III

## USB Connection

---

Selects the USB connection method when this product is connected to a computer, etc.

Select MENU →  (Network) → [Ctrl w/ Smartphone] → [Ctrl w/ Smartphone] → [Off] beforehand.

1 MENU →  (Setup) → [USB Connection] → **desired setting.**

### Menu item details

#### Auto:

Establishes a Mass Storage or MTP connection automatically, depending on the computer or other USB devices to be connected. Windows 7, Windows 8.1, or Windows 10 computers are connected in MTP, and their unique functions are enabled for use.

#### Mass Storage:

Establishes a Mass Storage connection between this product, a computer, and other USB devices.

#### MTP:

Establishes an MTP connection between this product, a computer, and other USB devices. Windows 7, Windows 8.1, or Windows 10 computers are connected in MTP, and their unique functions are enabled for use.

- The memory card in memory card slot 1 is the connection target.

#### PC Remote:

Uses Imaging Edge to control the product from a computer, including such functions as shooting and storing images on the computer.

#### Note

- It may take some time to make the connection between this product and a computer when [USB Connection] is set to [Auto].

---

### Related Topic

- [PC Remote Settings: Still Img. Save Dest.](#)
- [PC Remote Settings: RAW+J PC Save Img](#)

Interchangeable Lens Digital Camera  
ILCE-7M3 α7III

## USB LUN Setting

---

Enhances compatibility by limiting of USB connection functions.

**1** MENU →  (Setup) → [USB LUN Setting] → desired setting.

### Menu item details

**Multi:**

Normally, use [Multi].

**Single:**

Set [USB LUN Setting] to [Single] only if you cannot make a connection.

Interchangeable Lens Digital Camera  
ILCE-7M3 α7III

## USB Power Supply

---

Sets whether to supply power via the USB cable when the product is connected to a computer or an USB device.

**1** MENU →  (Setup) → [USB Power Supply] → desired setting.

### Menu item details

**On:**

Power is supplied to the product via a USB cable when the product is connected to a computer, etc.

**Off:**

Power is not supplied to the product via a USB cable when the product is connected to a computer, etc. If you use the supplied AC Adaptor, power will be supplied even when [Off] is selected.

**Note**

- Insert the battery pack into the product to supply power via USB cable.

Interchangeable Lens Digital Camera  
ILCE-7M3 α7III

## PC Remote Settings: Still Img. Save Dest.

Sets whether to save still images stored in both the camera and the computer during PC Remote shooting. This setting is useful when you want to check recorded images on the camera without leaving the camera.

\* PC Remote: Uses Imaging Edge to control the product from a computer, including such functions as shooting and storing images on the computer.

1 MENU →  (Setup) → [PC Remote Settings] → [Still Img. Save Dest.] → desired setting.

### Menu item details

#### PC Only:

Saves still images only on the computer.

#### PC+Camera:

Saves still images on the computer and the camera.

#### Note

- During PC Remote shooting, you cannot change settings for [Still Img. Save Dest.]. Adjust the settings before you start shooting.
- If you insert a memory card that is not recordable, you cannot shoot still images even if you select [PC+Camera].
- If you select [PC+Camera] and you have not inserted a memory card into the camera, you cannot release the shutter even if [Release w/o Card] is set to [Enable].
- During PC Remote shooting, [Recording Mode] under [Rec. Media Settings] is locked to [Standard] and cannot be changed.
- While you are playing back still images on the camera, you cannot shoot using PC Remote.

### Related Topic

- [USB Connection](#)
- [Release w/o Card](#)
- [PC Remote Settings: RAW+J PC Save Img](#)

Interchangeable Lens Digital Camera  
ILCE-7M3 α7III

## PC Remote Settings: RAW+J PC Save Img

Selects the file type for images to be transferred to the computer in PC Remote shooting.

When shooting still images using PC Remote, the application on the computer does not display the image until the image has been completely transferred. When performing RAW+JPEG shooting, you can accelerate the display processing speed by transferring only JPEG images instead of transferring both RAW and JPEG images.

\* PC Remote: Uses Imaging Edge to control the product from a computer, including such functions as shooting and storing images on the computer.

1 **MENU** →  (Setup) → **[PC Remote Settings]** → **[RAW+J PC Save Img]** → **desired setting.**

### Menu item details

#### RAW & JPEG:

Transfers both RAW and JPEG files to the computer.

#### JPEG Only:

Transfers only JPEG files to the computer.

#### RAW Only:

Transfers only RAW files to the computer.

#### Note

- The setting for [RAW+J PC Save Img] cannot be changed during PC Remote shooting. Adjust the setting before shooting.
- [RAW+J PC Save Img] can be set only when [ File Format] is set to [RAW & JPEG].
- During PC Remote shooting, [Recording Mode] under [Rec. Media Settings] is locked to [Standard] and cannot be changed.

### Related Topic

- [USB Connection](#)
- [File Format \(still image\)](#)
- [PC Remote Settings: Still Img. Save Dest.](#)

Interchangeable Lens Digital Camera  
ILCE-7M3 α7III

## Language

---

Selects the language to be used in the menu items, warnings and messages.

**1** MENU →  (Setup) → [ Language] → **desired language.**

Interchangeable Lens Digital Camera  
ILCE-7M3 α7III

## Date/Time Setup

---

The Clock Set screen is displayed automatically when you turn on this product for the first time or when the internal rechargeable backup battery has fully discharged. Select this menu when setting the date and time after the first time.

1 MENU →  (Setup) → [Date/Time Setup] → desired setting.

### Menu item details

**Daylight Savings:**

Selects Daylight Savings [On]/[Off].

**Date/Time:**

Sets the date and time.

**Date Format:**

Selects the date and time display format.

#### Hint

- To charge the internal rechargeable backup battery, insert a charged battery pack, and leave the product for 24 hours or more with the power off.
- If the clock resets every time the battery is charged, the internal rechargeable backup battery may be worn out. Consult your service facility.



Interchangeable Lens Digital Camera  
ILCE-7M3 α7III

## Area Setting

---

Sets the area where you are using the product.

**1** MENU →  (Setup) → [Area Setting] → desired area.

Interchangeable Lens Digital Camera  
ILCE-7M3 α7III

## Copyright Info

---

Writes copyright information onto the still images.

- 1 **MENU** →  (**Setup**) → **[Copyright Info]** → **desired setting**.
- 2 **When you select [Set Photographer] or [Set Copyright], a keyboard appears on the screen. Enter your desired name.**

### Menu item details

#### Write Copyright Info:

Sets whether to write copyright information. ([On]/[Off])

- If you select [On], an  icon will appear on the shooting screen.

#### Set Photographer:

Sets the photographer name.

#### Set Copyright:

Sets the copyright holder name.

#### Disp. Copyright Info:

Displays the current copyright information.

#### Note

- You can only enter alphanumeric characters and symbols for [Set Photographer] and [Set Copyright]. You can enter up to 46 letters.
- A  icon appears during the playback of images with copyright information.
- In order to prevent unauthorized use of [Copyright Info], be sure to clear the [Set Photographer] and [Set Copyright] columns before lending out or handing over your camera.
- Sony is not liable for problems or damages resulting from use of [Copyright Info].

---

### Related Topic

- [How to use the keyboard](#)

Interchangeable Lens Digital Camera  
ILCE-7M3 α7III

## Version

---

Displays the version of this product's software. Check the version when updates for this product's software are released, etc.

Also displays the version of the lens if a lens compatible with firmware updates is attached.

The version of the Mount Adaptor is displayed in the lens area if a Mount Adaptor compatible with firmware updates is attached.

1 MENU →  (Setup) → [Version].

### Note

- Updating can be performed only when the battery level is  (3 remaining battery bars) or more. Use a sufficiently charged battery pack.

Interchangeable Lens Digital Camera  
ILCE-7M3 α7III

## Demo Mode

---

The [Demo Mode] function displays the movies recorded on the memory card automatically (demonstration), when the camera has not been operated for a certain time. Normally select [Off].

1 MENU →  (Setup) → [Demo Mode] → desired setting.

### Menu item details

#### On:

The movie playback demonstration starts automatically if the product is not operated for about one minute. Only protected AVCHD movies can be played back.

Set the view mode to [AVCHD View], and protect the movie file with the oldest recorded date and time.

#### Off:

Does not show the demonstration.

#### Note

- You can set this item only when the product is powered by the AC Adaptor (supplied).
- When there is no protected AVCHD movies on the memory card, you cannot select [On].
- [Demo Mode] always displays movies on the memory card in memory card slot 1.

Interchangeable Lens Digital Camera  
ILCE-7M3 α7III

## Setting Reset

---

Resets the product to the default settings. Even if you perform [Setting Reset], the recorded images are retained.

1 MENU →  (Setup) → [Setting Reset] → desired setting.

### Menu item details

#### Camera Settings Reset:

Initializes the main shooting settings to the default settings.

#### Initialize:

Initializes all the settings to the default settings.

#### Note

- Be sure not to eject the battery pack while resetting.
- The value set with [AF Micro Adj.] will not be reset even when [Camera Settings Reset] or [Initialize] is performed.
- Settings of [Picture Profile] will not be reset even when [Camera Settings Reset] or [Initialize] is performed.

---

### Related Topic

- [AF Micro Adj.](#)
- [List of default setting values](#)

Interchangeable Lens Digital Camera  
ILCE-7M3 α7III

## PlayMemories Mobile

---

Using the smartphone application PlayMemories Mobile, you can shoot an image while controlling the camera using a smartphone or transfer the images recorded on the camera to the smartphone. Download and install the application PlayMemories Mobile from your smartphone's application store. If PlayMemories Mobile is already installed on your smartphone, be sure to update it to the latest version.

For details on PlayMemories Mobile, refer to the support page (<http://www.sony.net/pmm/>).

### Note

- Depending on future version upgrades, the operational procedures or screen displays are subject to change without notice.

Interchangeable Lens Digital Camera  
ILCE-7M3 α7III

## Controlling the camera using an Android smartphone (NFC One-touch remote)

You can connect this product to an NFC-enabled Android smartphone by touching them together and then operate the product using the smartphone.

Make sure that [Ctrl w/ Smartphone] is set to [On] by selecting MENU →  (Network) → [Ctrl w/ Smartphone].

**1 Activate the NFC function of the smartphone.**

**2 Switch this product to shooting mode.**

- The NFC function is available only when the  (N mark) is displayed on the screen.

**3 Touch the smartphone to the product.**

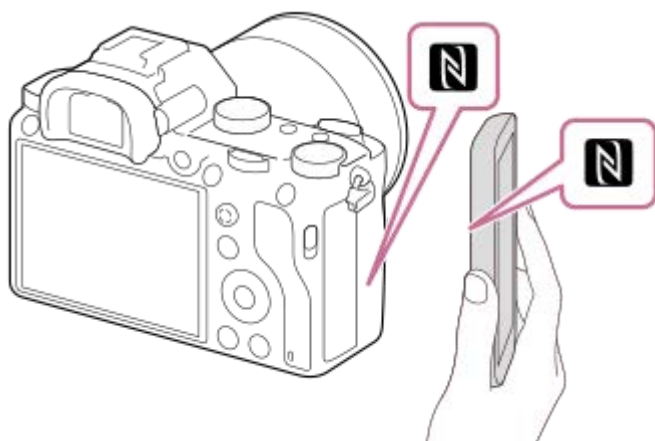

The smartphone and the product are connected, and PlayMemories Mobile launches.

- You can shoot an image by remote control while checking the composition of the image on the smartphone screen.
- Touch the smartphone to the product for 1-2 seconds until PlayMemories Mobile launches.

### About “NFC”

NFC is a technology that enables short-range wireless communication between various devices, such as mobile phones or IC tags, etc. NFC makes data communication simpler with just a touch on the designated touch-point.

- NFC (Near Field Communication) is an international standard of short-range wireless communication technology.

### Note

- If you cannot make a connection, do as the following:
  - Launch PlayMemories Mobile on your smartphone, and then move the smartphone slowly toward the  (N mark) of this product.
  - If the smartphone is in a case, remove it.
  - If the product is in a case, remove it.
  - Check whether the NFC function is activated on your smartphone.
- Radio wave interference may occur as Bluetooth communications and Wi-Fi communications use the same frequency band. If your Wi-Fi connection is unstable, it may be improved by turning off the Bluetooth function of the smartphone. If you do this, the location information link function is not available.

- When [Airplane Mode] is set to [On], you cannot connect this product and the smartphone. Set [Airplane Mode] to [Off].
- If this product and the smartphone are connected when the product is in playback mode, the displayed image is sent to the smartphone.

---

### Related Topic

- [PlayMemories Mobile](#)
- [Airplane Mode](#)

4-732-947-11(1) Copyright 2018 Sony Corporation



## Controlling the camera using an Android smartphone (QR code)

You can control this product using your smartphone by connecting your smartphone to the camera using the QR code. Make sure that [Ctrl w/ Smartphone] is set to [On] by selecting MENU →  (Network) → [Ctrl w/ Smartphone].

- 1 MENU →  (Network) → [Ctrl w/ Smartphone] → [ Connection].

QR code (A) and the SSID (B) are displayed on the monitor of this product.



- 2 Launch PlayMemories Mobile on your smartphone and select [Scan QR Code of the Camera].

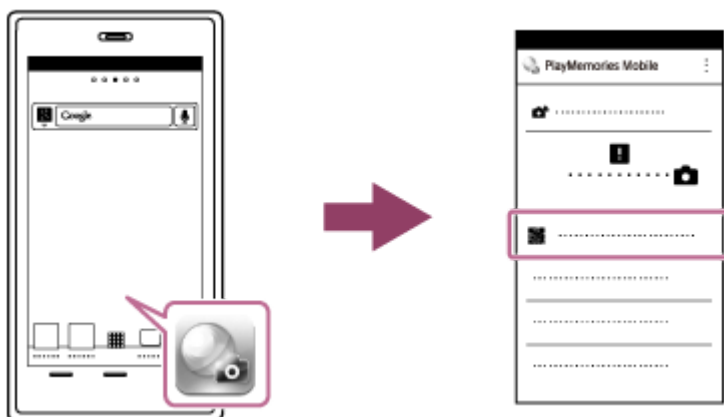

- 3 Select [OK] on the smartphone screen.

- When a message is displayed, select [OK] again.



- 4 Read the QR code displayed on the monitor of this product with the smartphone.

Once the QR code has been read, a message [Connect with the camera?] will be displayed on the smartphone screen.

**5 Select [OK] on the smartphone screen.**

The smartphone is connected to the product.

- You can now shoot images remotely while checking the composition on the smartphone screen.

**Hint**

- Once the QR code has been read, this product's SSID (DIRECT-xxxx) and password are registered to the smartphone. This enables you to easily connect the smartphone to the product via Wi-Fi at a later date by selecting the SSID. (Set [Ctrl w/ Smartphone] to [On] in advance.)

**Note**

- Radio wave interference may occur as Bluetooth communications and Wi-Fi communications use the same frequency band. If your Wi-Fi connection is unstable, it may be improved by turning off the Bluetooth function of the smartphone. If you do this, the location information link function is not available.
- If you cannot connect your smartphone to this product using the [One-touch(NFC)] function or QR code, use the SSID and password.

---

**Related Topic**

- [PlayMemories Mobile](#)
- [Controlling the camera using an Android smartphone \(SSID\)](#)

Interchangeable Lens Digital Camera  
ILCE-7M3 α7III

## Controlling the camera using an Android smartphone (SSID)

You can control this product using your smartphone by connecting your smartphone to the camera using the SSID and password.

Make sure that [Ctrl w/ Smartphone] is set to [On] by selecting MENU →  (Network) → [Ctrl w/ Smartphone].

- 1 MENU →  (Network) → [Ctrl w/ Smartphone] → [ Connection].

QR code is displayed on the monitor of this product.

- 2 Press the  (Delete) button of this product.

This product's SSID and password are displayed on the monitor of this product.

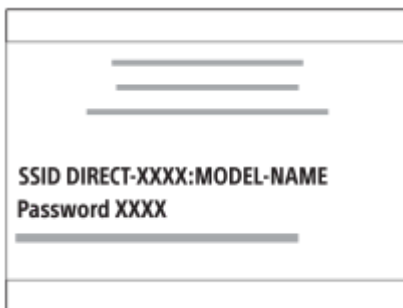

- 3 Launch PlayMemories Mobile on your smartphone.
- 4 Select the model name of this product (DIRECT-xxxx: xxxx).



- 5 Input the password that is displayed on this product.



The smartphone is connected to the product.

- You can now shoot images remotely while checking the composition on the smartphone screen.

### Note

- Radio wave interference may occur as Bluetooth communications and Wi-Fi communications use the same frequency band. If your Wi-Fi connection is unstable, it may be improved by turning off the Bluetooth function of the smartphone. If you do this, the location information link function is not available.

---

### Related Topic

- [PlayMemories Mobile](#)

## Controlling the camera using an iPhone or iPad (QR code)

You can connect an iPhone or iPad to the camera using the QR code and operate the camera using the iPhone or iPad. Make sure that [Ctrl w/ Smartphone] is set to [On] by selecting MENU →  (Network) → [Ctrl w/ Smartphone].

- 1 MENU →  (Network) → [Ctrl w/ Smartphone] → [ Connection].

QR code (A) and the SSID (B) are displayed on the monitor of this product.



- 2 Launch PlayMemories Mobile on your iPhone or iPad and select [Scan QR Code of the Camera].

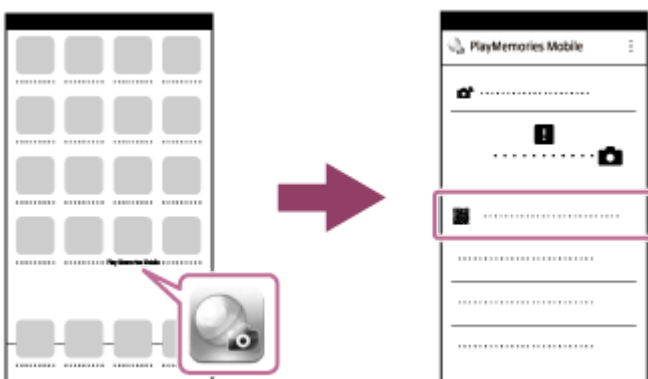

- 3 Select [OK] on the iPhone or iPad screen.

- When a message is displayed, select [OK] again.



- 4 Read the QR code displayed on the monitor of this product with the iPhone or iPad.

**5 Install the profile (setting information) by following the instructions shown on the iPhone or iPad screen and select [OK].**

The profile will be installed to the iPhone or iPad.

- If you have activated the passcode lock function for your iPhone or iPad, you will need to enter the passcode. Enter the passcode that you set for your iPhone or iPad.



**6 Select [Settings] on the "Home" screen → [Wi-Fi] → the SSID for this product on the iPhone or iPad.**

The iPhone or iPad will connect to the product.



**7 Return to the "Home" screen of the iPhone or iPad and launch PlayMemories Mobile.**

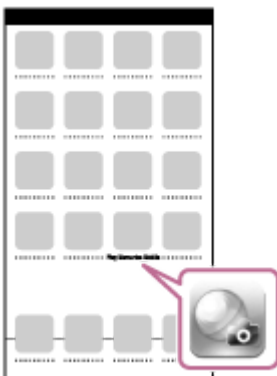

- You can now shoot images remotely while checking the composition on the screen of your iPhone or iPad.

**Hint**

- Once the QR code has been read, this product's SSID (DIRECT-xxxx) and password are registered to the iPhone or iPad. This enables you to easily connect the iPhone or iPad to the product via Wi-Fi at a later date by selecting the SSID. (Set [Ctrl w/ Smartphone] to [On] in advance.)

## Note

- Radio wave interference may occur as Bluetooth communications and Wi-Fi communications use the same frequency band. If your Wi-Fi connection is unstable, it may be improved by turning off the Bluetooth function of the smartphone. If you do this, the location information link function is not available.
- If you cannot connect your iPhone or iPad to this product using the QR code, use the SSID and password.

---

## Related Topic

- [PlayMemories Mobile](#)
- [Controlling the camera using an iPhone or iPad \(SSID\)](#)

4-732-947-11(1) Copyright 2018 Sony Corporation

Interchangeable Lens Digital Camera  
ILCE-7M3 α7III

## Controlling the camera using an iPhone or iPad (SSID)

You can control the camera using an iPhone or iPad by connecting the iPhone or iPad to the camera using the SSID and password.

Make sure that [Ctrl w/ Smartphone] is set to [On] by selecting MENU →  (Network) → [Ctrl w/ Smartphone].

- 1 MENU →  (Network) → [Ctrl w/ Smartphone] → [ Connection].**

QR code is displayed on the monitor of this product.

- 2 Press the  (Delete) button of this product.**

This product's SSID and password are displayed on the monitor of this product.

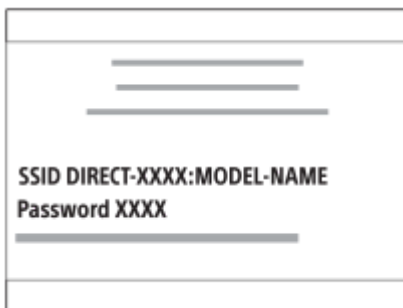

- 3 Select the model name of this product (DIRECT-xxxx: xxxx) on the Wi-Fi setting screen of your iPhone or iPad.**



- 4 Input the password that is displayed on this product.**





The iPhone or iPad is connected to the product.

- 5 Confirm that your iPhone or iPad was connected to the "SSID" shown on this product.

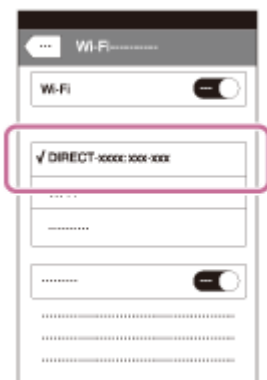

- 6 Return to the "Home" screen of the iPhone or iPad and launch PlayMemories Mobile.



- You can now shoot images remotely while checking the composition on the screen of your iPhone or iPad.

#### Note

- Radio wave interference may occur as Bluetooth communications and Wi-Fi communications use the same frequency band. If your Wi-Fi connection is unstable, it may be improved by turning off the Bluetooth function of the smartphone. If you do this, the location information link function is not available.

---

#### Related Topic

- [PlayMemories Mobile](#)

Interchangeable Lens Digital Camera  
ILCE-7M3 α7III

## Snd to Smrtphn Func: Send to Smartphone

You can transfer still images, XAVC S movies, slow-motion movies, or quick-motion movies to a smartphone and view them. The application PlayMemories Mobile must be installed on your smartphone.

**1 MENU →  (Network) → [Snd to Smrtphn Func] → [Send to Smartphone] → desired setting.**

- If you press the  (Send to Smartphone) button in playback mode, the setting screen for [Send to Smartphone] will appear.

**2 If the product is ready for the transfer, the information screen appears on the product. Connect the smartphone and the product using that information.**

- The setting method for connecting the smartphone and the product varies depending on the smartphone.



### Menu item details

#### Select on This Device:

Selects an image on the product to be transferred to the smartphone.

(1) Select from among [This Image], [All with this date] or [Multiple Images].

- The options displayed may differ depending on the View Mode selected on the camera.

(2) If you select [Multiple Images], select the desired images using the center of the control wheel, then press MENU → [Enter].

#### Select on Smartphone:

Displays all images recorded on the product's memory card on the smartphone.

#### Note

- You can only transfer images that are saved on the camera's memory card.
- You can only transfer images that are saved on the memory card in the memory card slot being played back. To change which memory card slot is being played back, select MENU →  (Playback) → [Select PB Media] → the desired slot.
- You can select an image size to be sent to the smartphone from [Original], [2M] or [VGA]. To change the image size, refer to the following steps.
  - For Android smartphone  
Start PlayMemories Mobile, and change the image size by [Settings] → [Copy Image Size].
  - For iPhone/iPad  
Select PlayMemories Mobile in the setting menu, and change the image size by [Copy Image Size].
- RAW images are converted to JPEG format when they are sent.
- You cannot send AVCHD format movies.

- You cannot transfer XAVC S 4K movies or the original data of XAVC S HD movies recorded in [120p]/[100p] to a smartphone. You can only transfer proxy movies.
- Depending on the smartphone, the transferred movie may not be played back correctly. For example, the movie may not play smoothly, or there may be no sound.
- Depending on the format of the still image, movie, slow-motion movie, or quick-motion movie, it may not be possible to play it back on a smartphone.
- This product shares the connection information for [Send to Smartphone] with a device that has permission to connect. If you want to change the device that is permitted to connect to the product, reset the connection information by following these steps. MENU →  (Network) → [Wi-Fi Settings] → [SSID/PW Reset]. After resetting the connection information, you must register the smartphone again.
- When [Airplane Mode] is set to [On], you cannot connect this product and the smartphone. Set [Airplane Mode] to [Off].
- While you transfer many images or long movies, we recommend that you supply power to the camera from a wall outlet (wall socket) using the AC Adaptor (supplied).

---

## Related Topic

- [PlayMemories Mobile](#)
- [Controlling the camera using an Android smartphone \(NFC One-touch remote\)](#)
- [Controlling the camera using an Android smartphone \(QR code\)](#)
- [Controlling the camera using an Android smartphone \(SSID\)](#)
- [Controlling the camera using an iPhone or iPad \(QR code\)](#)
- [Controlling the camera using an iPhone or iPad \(SSID\)](#)
- [Sending images to an Android smartphone \(NFC One-touch Sharing\)](#)
- [Send to Smartphone Func: Sending Target \(proxy movies\)](#)
- [Airplane Mode](#)

Interchangeable Lens Digital Camera  
ILCE-7M3 α7III

## Snd to Smrtphn Func: Sending Target (proxy movies)

---

When transferring XAVC S video to a smartphone with [Send to Smartphone], you can set whether to transfer the low-bit-rate proxy movie or the high-bit-rate original movie.

1 MENU →  (Network) → [Snd to Smrtphn Func] → [  Sending Target ] → desired setting.

### Menu item details

#### Proxy Only:

Transfers only proxy movies.

#### Original Only:

Transfers only original movies.

#### Proxy & Original:

Transfers both proxy and original movies.

#### Note

- You cannot transfer XAVC S 4K movies or the original data of XAVC S HD movies recorded in [120p]/[100p] to a smartphone. You can only transfer proxy movies.
- While you transfer many images or long movies, we recommend that you supply power to the camera from a wall outlet (wall socket) using the AC Adaptor (supplied).

---

### Related Topic

- [Snd to Smrtphn Func: Send to Smartphone](#)
- [Proxy Recording](#)

Interchangeable Lens Digital Camera  
ILCE-7M3 α7III

## Sending images to an Android smartphone (NFC One-touch Sharing)

With just one touch, you can connect this product and an NFC-enabled Android smartphone, and send an image displayed on the product screen directly to the smartphone. You can transfer still images, XAVC S movies and slow-motion and quick-motion movies.

- 1 **Activate the NFC function of the smartphone.**
- 2 **Display a single image on the product.**
- 3 **Touch the smartphone to the product.**

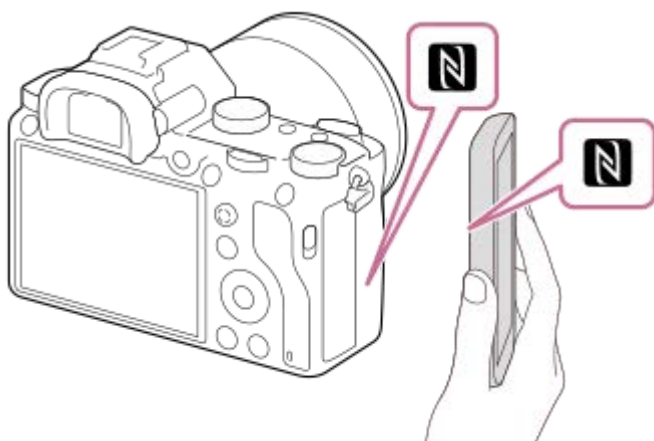

The product and the smartphone are connected, and PlayMemories Mobile automatically launches on the smartphone, and then the displayed image is sent to the smartphone.

- Before you touch the smartphone, cancel the sleep and lock-screen functions of the smartphone.
- The NFC function is available only when the (N mark) is displayed on the product.
- Touch the smartphone to the product for 1-2 seconds until PlayMemories Mobile launches.
- To transfer two or more images, select MENU → (Network) → [Snd to Smrtphn Func] → [Send to Smartphone] to select images. After the connection enabled screen appears, use NFC to connect the product and the smartphone.

### About “NFC”

NFC is a technology that enables short-range wireless communication between various devices, such as mobile phones or IC tags, etc. NFC makes data communication simpler with just a touch on the designated touch-point.

- NFC (Near Field Communication) is an international standard of short-range wireless communication technology.

#### Note

- You can only transfer images that are saved on the memory card in the memory card slot being played back. To change the memory card slot to be played back, select MENU → (Playback) → [Select PB Media] → the desired slot.
- You can select an image size to be sent to the smartphone from [Original], [2M] or [VGA]. To change the image size, refer to the following steps.
  - Start PlayMemories Mobile, and change the image size by [Settings] → [Copy Image Size].

- RAW images are converted to JPEG format when they are sent.
- You cannot send AVCHD format movies.
- You cannot transfer XAVC S 4K movies or the original data of XAVC S HD movies recorded in [120p]/[100p] to a smartphone. You can only transfer proxy movies.
- Depending on the smartphone, the transferred movie may not be played back correctly. For example, the movie may not play smoothly, or there may be no sound.
- If the Image Index is displayed on the product, you cannot transfer images using the NFC function.
- If you cannot make a connection, do as the following:
  - Launch PlayMemories Mobile on your smartphone, and then move the smartphone slowly toward the  (N mark) of this product.
  - If the smartphone is in a case, remove it.
  - If the product is in a case, remove it.
  - Check whether the NFC function is activated on your smartphone.
- When [Airplane Mode] is set to [On], you cannot connect the product and the smartphone. Set [Airplane Mode] to [Off].

---

### Related Topic

- [PlayMemories Mobile](#)
- [Snd to Smrtphn Func: Send to Smartphone](#)
- [Snd to Smrtphn Func: Sending Target \(proxy movies\)](#)
- [Airplane Mode](#)

Interchangeable Lens Digital Camera  
ILCE-7M3 α7III

## Send to Computer

---

You can transfer images stored in the product to a computer connected to a wireless access point or wireless broadband router and easily make backup copies using this operation. Before starting this operation, install PlayMemories Home on your computer and register the access point on the product.

**1 Start your computer.**

**2 MENU →  (Network) → [Send to Computer] → the desired memory card slot.**

### Note

- Depending on the application settings of your computer, the product will turn off after saving the images to your computer.
- You can transfer images from the product to only one computer at a time.
- If you want to transfer images to another computer, connect the product and the computer via a USB connection and follow the instructions in PlayMemories Home.
- Proxy movies cannot be transferred.

---

### Related Topic

- [Installing PlayMemories Home](#)
- [Wi-Fi Settings: WPS Push](#)
- [Wi-Fi Settings: Access Point Set.](#)

Interchangeable Lens Digital Camera  
ILCE-7M3 α7III

## FTP Transfer Func.

---

You can set up image transferring using an FTP server or transfer images to the FTP server. Basic knowledge of FTP servers is required.

For details, refer to the “FTP Help Guide.”

[http://rd1.sony.net/help/di/ftp/h\\_zz/](http://rd1.sony.net/help/di/ftp/h_zz/)

**1** MENU →  (Network) → [FTP Transfer Func.] → desired setting.

### Menu item details

**FTP Transfer:**

Connects the camera to the network, and transfers images to the FTP server.

**Display FTP Result:**

Displays the results of the most recent FTP transfer.

**Select FTP Server:**

Selects the destination FTP server.

**FTP Server 1/FTP Server 2/FTP Server 3:**

Sets up FTP Servers 1 – 3.

---

### Related Topic

- [Importing root certification to the camera \(Imp Root Certificate\)](#)



Interchangeable Lens Digital Camera  
ILCE-7M3 α7III

## View on TV

You can view images on a network-enabled TV by transferring them from the product without connecting the product and TV with a cable. For some TVs, you may need to perform operations on the TV. For details, refer to the operating instructions supplied with the TV.

1 MENU →  (Network) → [View on TV] → **desired device to be connected.**

2 When you want to play back images using slideshow, press the center of the control wheel.

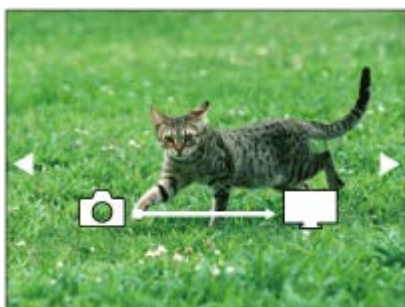

- To display the next/previous image manually, press the right/left sides of the control wheel.
- To change the device to be connected, press the down side of the control wheel, then select [Device list].

## Slideshow settings

You can change the slideshow settings by pressing the down side of the control wheel.

### Playback Selection:

Selects the group of images to be shown.

### Folder View(Still):

Selects from [All] and [All in Folder].

### Date View:

Selects from [All] and [All in Date Rng.].

### Interval:

Selects from [Short] and [Long].

### Effects\*:

Selects from [On] and [Off].

### Playback Image Size:

Selects from [HD] and [4K].

\* The settings are effective only for BRAVIA TV which is compatible with the functions.

## Note

- You can only transfer images that are saved on the memory card in the memory card slot being played back. To change the memory card slot to be played back, select MENU →  (Playback) → [Select PB Media] → the desired slot.
- You can use this function on a TV that supports DLNA renderer.
- You can view images on a Wi-Fi Direct-enabled TV or network-enabled TV (including wired network-enabled TVs).
- If you connect TV and this product and do not use Wi-Fi Direct, you need to register your access point first.
- Displaying the images on the TV may take time.
- Movies cannot be shown on a TV via Wi-Fi. Use an HDMI cable (sold separately).

---

---

**Related Topic**

- [Wi-Fi Settings: WPS Push](#)
- [Wi-Fi Settings: Access Point Set.](#)

4-732-947-11(1) Copyright 2018 Sony Corporation

Interchangeable Lens Digital Camera  
ILCE-7M3 α7III

## Loc. Info. Link Set.

You can use the application PlayMemories Mobile to obtain location information from a smartphone that is connected with your camera using Bluetooth communication. You can record the obtained location information when shooting images.

### Preparation in advance









To use the location information linking function of the camera, the application PlayMemories Mobile is required. If “Location Information Linkage” is not displayed on the top page of PlayMemories Mobile, you need to perform the following steps beforehand.



1. Install PlayMemories Mobile on your smartphone.
  - You can install PlayMemories Mobile from the application store of your smartphone. If you have already installed the application, update it to the latest version.
2. Transfer a pre-recorded image to your smartphone using the [Send to Smartphone] function of the camera.
  - After you transfer an image recorded using the camera to your smartphone, “Location Information Linkage” will appear on the top page of the application.

### Operating procedure

: Operations performed on the smartphone

: Operations performed on the camera

1. : Confirm that the Bluetooth function of your smartphone is activated.
  - Do not perform the Bluetooth pairing operation on the smartphone setting screen. In steps 2 to 7, the pairing operation is performed using the camera and the application PlayMemories Mobile.
  - If you accidentally perform the pairing operation on the smartphone setting screen in step 1, cancel the pairing and then perform the pairing operation by following Steps 2 through 7 using the camera and the application PlayMemories Mobile.
2. : On the camera, select MENU →  (Network) → [Bluetooth Settings] → [Bluetooth Function] → [On].
3. : On the camera, select MENU →  (Network) → [Bluetooth Settings] → [Pairing].
4. : Launch PlayMemories Mobile on your smartphone and tap “Location Information Linkage.”
  - If “Location Information Linkage” is not displayed, follow the steps in “Preparation in advance” above.
5. : Activate [Location Information Linkage] on the [Location Information Linkage] setting screen of PlayMemories Mobile.
6. : Follow the instructions on the [Location Information Linkage] setting screen of PlayMemories Mobile, and then select your camera from the list.
7. : Select [OK] when a message is displayed on the monitor of the camera.
  - Pairing of the camera and PlayMemories Mobile is complete.

8.  : On the camera, select MENU →  (Network) → [ Loc. Info. Link Set.] → [Location Info. Link] → [On].

-  (obtaining location information icon) will be displayed on the monitor of the camera. Location information obtained by your smartphone using GPS, etc., will be recorded when shooting images.

## Menu item details

### Location Info. Link:

Sets whether to obtain the location information by linking with a smartphone.

### Auto Time Correct.:

Sets whether to automatically correct the date setting of the camera using information from a linked smartphone.

### Auto Area Adjust.:

Sets whether to automatically correct the area setting of the camera using information from a linked smartphone.

## Icons displayed when obtaining the location information

 (Obtaining location information): The camera is obtaining the location information.

 (Location information cannot be obtained): The camera cannot obtain the location information.

 (Bluetooth connection available): Bluetooth connection with the smartphone is established.

 (Bluetooth connection unavailable): Bluetooth connection with the smartphone is not established.

### Hint

- Location information can be linked when PlayMemories Mobile is running on your smartphone even if the smartphone monitor is off. However, if the camera has been turned off for a while, location information may not be linked immediately when you turn the camera back on. In this case, location information will be linked immediately if you open the PlayMemories Mobile screen on the smartphone.
- When PlayMemories Mobile is not operating, such as when the smartphone is restarted, launch PlayMemories Mobile to resume location information linking.
- In the application PlayMemories Home, you can view images on a map by importing images with location information to your computer. For details, refer to Help for PlayMemories Home.
- If the location information linking function does not work properly, see the following notes and perform pairing again.
  - Confirm that the Bluetooth function of your smartphone is activated.
  - Confirm that the camera is not connected with other devices using the Bluetooth function.
  - Confirm that [Airplane Mode] for the camera is set to [Off].
  - Delete the pairing information for the camera registered in PlayMemories Mobile.
  - Execute [Reset Network Set.] of the camera.
- For more detailed video instructions, refer to the following support page.  
<http://www.sony.net/pmm/btg/>

### Note

- When you initialize the camera, the pairing information is also deleted. To perform pairing again, delete the pairing information for the camera registered in PlayMemories Mobile before trying again.
- The location information will not be recorded when it cannot be obtained, such as when the Bluetooth connection is disconnected.
- The camera can be paired with up to 15 Bluetooth devices, but can link the location information with that of only one smartphone. If you want to link the location information with that of another smartphone, turn off the [Location Information Linkage] function of the smartphone that is already linked.
- If the Bluetooth connection is unstable, remove any obstacles, such as people or metal objects from between the camera and the paired smartphone.
- When pairing the camera and your smartphone, be sure to use the [Location Information Linkage] menu on PlayMemories Mobile.

## Supported smartphones

- Android smartphones: Android 5.0 or later and compatible with Bluetooth 4.0 or later\*

- [iPhone/iPad: iPhone 4S or later/iPad 3rd generation or later](#)

\* For the latest information, refer to the support site.

\* For the Bluetooth version, refer to the website for your smartphone.

---

---

## Related Topic

- [PlayMemories Home](#)
- [PlayMemories Mobile](#)
- [Snd to Smrtphn Func: Send to Smartphone](#)
- [Bluetooth Settings](#)

4-732-947-11(1) Copyright 2018 Sony Corporation

Interchangeable Lens Digital Camera  
ILCE-7M3 α7III

## Airplane Mode

---

When you board an airplane, etc., you can temporarily disable all the wireless-related functions including Wi-Fi.

**1** MENU →  (Network) → [Airplane Mode] → **desired setting.**

If you set [Airplane Mode] to [On], an airplane mark will be displayed on the screen.

Interchangeable Lens Digital Camera  
ILCE-7M3 α7III

## Wi-Fi Settings: WPS Push

---

If your access point has a Wi-Fi Protected Setup (WPS) button, you can register the access point to this product easily.

- 1 MENU →  (Network) → [Wi-Fi Settings] → [WPS Push].
- 2 Push the Wi-Fi Protected Setup (WPS) button on the access point to connect.

### Note

- [WPS Push] works only if the security setting of your access point is set to WPA or WPA2 and your access point supports the Wi-Fi Protected Setup (WPS) button method. If the security setting is set to WEP or your access point does not support the Wi-Fi Protected Setup (WPS) button method, perform [Access Point Set.].
- For details about the available functions and settings of your access point, see the access point operating instructions or contact the administrator of the access point.
- A connection may not be possible or the communication distance may be shorter depending on the surrounding conditions, such as the type of wall material and the presence of obstructions or radio waves between the product and access point. In this case, change the location of the product or move the product closer to the access point.

---

### Related Topic

- [Wi-Fi Settings: Access Point Set.](#)

## Wi-Fi Settings: Access Point Set.

You can register your access point manually. Before starting the procedure, check the SSID name of the access point, security system, and password. The password may be preset in some devices. For details, see the access point operating instructions, or consult the access point administrator.

1 MENU →  (Network) → [Wi-Fi Settings] → [Access Point Set.].

2 Select the access point you want to register.

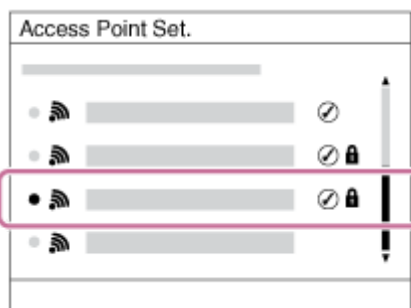

**When the desired access point is displayed on the screen:** Select the desired access point.

**When the desired access point is not displayed on the screen:** Select [Manual Setting] and set the access point.

- If you select [Manual Setting], input the SSID name of the access point, then select the security system.

3 Input the password, and select [OK].

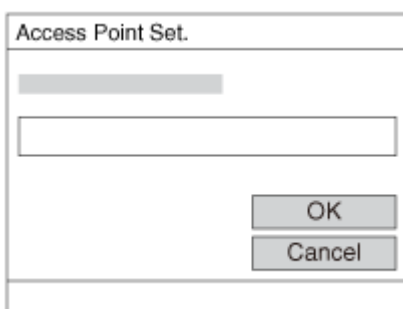

- Access points without the  mark do not require a password.

4 Select [OK].

### Other setting items

Depending on the status or the setting method of your access point, you may want to set more items.

#### WPS PIN:

Displays the PIN code you enter into the connected device.

#### Priority Connection:

Select [On] or [Off].

#### IP Address Setting:



Select [Auto] or [Manual].

**IP Address:**

If you are entering the IP address manually, enter the set address.

**Subnet Mask/Default Gateway/Primary DNS Server/Second DNS Server:**

If you have set [IP Address Setting] to [Manual], enter each address according to your network environment.

**Note**

- To give the registered access point priority in the future, set [Priority Connection] to [On].

---

**Related Topic**

- [Wi-Fi Settings: WPS Push](#)
- [How to use the keyboard](#)

Interchangeable Lens Digital Camera  
ILCE-7M3 α7III

## Wi-Fi Settings: Disp MAC Address

---

Displays the MAC address of this product.

**1** MENU →  (Network) → [Wi-Fi Settings] → [Disp MAC Address].

Interchangeable Lens Digital Camera  
ILCE-7M3 α7III

## Wi-Fi Settings: SSID/PW Reset

This product shares the connection information for [Send to Smartphone] and [Connection] with a device that has permission to connect. If you want to change the device that is permitted to connect, reset the connection information.

**1** MENU →  (Network) → [Wi-Fi Settings] → [SSID/PW Reset] → [OK].

### Note

- If you connect this product to a smartphone after resetting the connection information, you must make the settings for the smartphone again.

### Related Topic

- [Snd to Smrtphn Func: Send to Smartphone](#)
- [Ctrl w/ Smartphone](#)

Interchangeable Lens Digital Camera  
ILCE-7M3 α7III

## Edit Device Name

---

You can change the device name for the Wi-Fi Direct or Bluetooth connection.

- 1 MENU →  (Network) → [Edit Device Name].**
- 2 Select the input box, then input the device name→[OK].**

---

### Related Topic

- [Wi-Fi Settings: WPS Push](#)
- [Wi-Fi Settings: Access Point Set.](#)
- [How to use the keyboard](#)

Interchangeable Lens Digital Camera  
ILCE-7M3 α7III

## Importing root certification to the camera (Imp Root Certificate)

---

Imports a root certificate needed to verify a server from a memory card. Use this function for encrypted communications during FTP transfer.

For details, refer to the “FTP Help Guide.”

[http://rd1.sony.net/help/di/ftp/h\\_zz/](http://rd1.sony.net/help/di/ftp/h_zz/)

**1** MENU →  (Network) → [Imp Root Certificate].

Interchangeable Lens Digital Camera  
ILCE-7M3 α7III

## Reset Network Set.

---

Resets all the network settings to default settings.

**1** MENU →  (Network) → [Reset Network Set.] → [Enter].

Interchangeable Lens Digital Camera  
ILCE-7M3 α7III

## Recommended computer environment

---

You can confirm the operating computer environment of the software from the following URL:

<http://www.sony.net/pcenv/>

Interchangeable Lens Digital Camera  
ILCE-7M3 α7III

## Software for Mac computers

---

For details on software for Mac computers, access the following URL:

<http://www.sony.co.jp/imsoft/Mac/>

### Note

- The software that can be used varies depending on the region.

---

### Related Topic

- [Send to Computer](#)



Interchangeable Lens Digital Camera  
ILCE-7M3 α7III

## PlayMemories Home

---

With PlayMemories Home, you can do the following:

- You can import images shot with this product to your computer.
- You can play back the images imported to your computer.
- You can share your images using PlayMemories Online.
- You can edit movies such as by cutting or merging.
- You can add various effects such as BGM and subtitles to movies.

Also for Windows, you can do the following:

- You can organize images on the computer on a calendar by shooting date to view them.
- You can edit and correct images, such as by trimming and resizing.
- You can create a disc from movies imported to a computer.  
Blu-ray discs or AVCHD discs can be created from XAVC S-format movies.
- You can upload images to a network service. (An Internet connection is required.)
- You can import images recorded with location information to a computer and view them on a map.
- For other details, please refer to the Help of PlayMemories Home.

---

### Related Topic

- [Installing PlayMemories Home](#)

Interchangeable Lens Digital Camera  
ILCE-7M3 α7III

## Installing PlayMemories Home

- 1 Using your computer's Internet browser, go to the URL below and download PlayMemories Home by following the on-screen instructions.

<http://www.sony.net/pm/>

- An Internet connection is required.
- For detailed instructions, visit the PlayMemories Home support page (English only).  
<http://www.sony.co.jp/pmh-se/>

- 2 Connect the product to your computer using the USB cable, then turn the product on.

- New functions may be added to PlayMemories Home. Even if PlayMemories Home has already been installed on your computer, connect this product and your computer again.
- Do not remove the USB cable from the camera while the camera is in operation or the access screen is displayed. Doing so may damage the data.

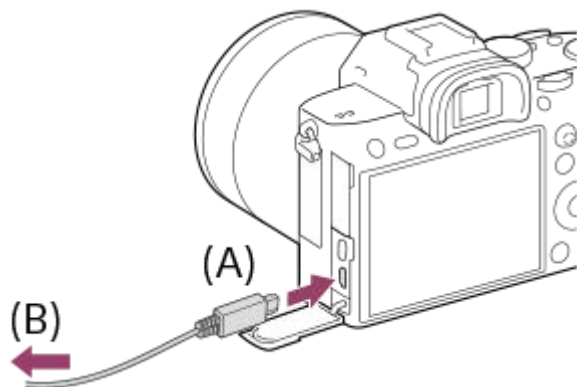

**A:** To the Multi/Micro USB Terminal  
**B:** To the USB jack of the computer

### Note

- Log on as Administrator.
- It may be necessary to restart your computer. When the restart confirmation message appears, restart the computer following the instructions on the screen.
- DirectX may be installed depending on your computer's system environment.

Interchangeable Lens Digital Camera  
ILCE-7M3 α7III

## Connecting to a computer

- 1 Insert a sufficiently charged battery pack into the camera.
- 2 Turn on the camera and the computer.
- 3 Check that [USB Connection] under  (Setup) is set to [Mass Storage].
- 4 Connect the camera to the computer using the USB cable (A).

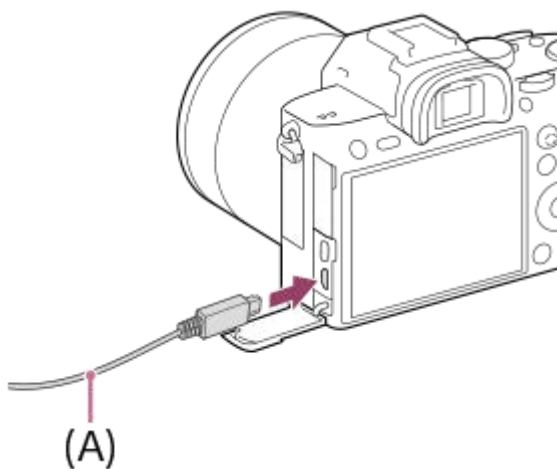

- When you connect the camera to the computer for the first time, the procedure for recognizing the camera may start automatically on the computer. Wait until the procedure is finished.
- If you connect the product to your computer using the USB cable when [USB Power Supply] is set to [On], power is supplied from your computer. (Default setting: [On])
- Use a USB 3.1-compatible computer and the USB Type-C cable (sold separately) for higher-speed communications.

### Note

- Do not turn on/off or restart the computer, or wake the computer from sleep mode when a USB connection has been established between the computer and the camera. Doing so may cause a malfunction. Before turning on/off or restarting the computer, or waking the computer from sleep mode, disconnect the camera from the computer.

### Related Topic

- [USB Connection](#)
- [USB LUN Setting](#)

Interchangeable Lens Digital Camera  
ILCE-7M3 α7III

## Importing images to the computer without using PlayMemories Home

---

PlayMemories Home allows you to easily import images. For details on PlayMemories Home functions, see the Help of PlayMemories Home.

### Importing images to the computer without using PlayMemories Home (For Windows)

When the AutoPlay Wizard appears after making a USB connection between this product and a computer, click [Open folder to view files] → [OK] → [DCIM]. Then copy the desired images to the computer.

### Importing images to the computer without using PlayMemories Home (For Mac)

Connect the product to your Mac computer. Double-click the newly recognized icon on the desktop → the folder in which the image you want to import is stored. Then drag and drop the image file on to the hard disk icon.

#### Note

- For operations such as importing XAVC S movies or AVCHD movies to the computer, use PlayMemories Home.
- Do not edit or otherwise process AVCHD or XAVC S movie files/folders from the connected computer. Movie files may be damaged or become unplayable. Do not delete or copy AVCHD movies or XAVC S movies on the memory card from the computer. Sony is not held liable for consequences resulting from such operations via the computer.

Interchangeable Lens Digital Camera  
ILCE-7M3 α7III

## Disconnecting the camera from the computer

---

Perform steps 1 and 2 below before performing the following operations:

- Disconnecting the USB cable.
- Removing a memory card.
- Turning off the product.

**1** Click  (Safely Remove Hardware and Eject Media ) in the taskbar.

**2** Click the displayed message.

### Note

- On Mac computers, drag and drop the memory card icon or the drive icon into the “Trash” icon. The camera will be disconnected from the computer.
- On Windows 7/Windows 8 computers, the disconnection icon may not appear. In that case, you can skip the steps above.
- Do not remove the USB cable from the camera while the access lamp is lit. The data may be damaged.

Interchangeable Lens Digital Camera  
ILCE-7M3 α7III

## Imaging Edge

---

Imaging Edge is a software suite that includes functions such as remote shooting from a computer, and adjusting or developing RAW images recorded with the camera.

### Viewer:

You can display and search images.

### Edit:

You can edit images with various corrections such as tone curve and sharpness, and develop images recorded in RAW format.

### Remote:

You can adjust the camera settings or shoot images from a computer connected to the camera with a USB cable. To control the camera using a computer, select MENU →  (Setup) → [USB Connection] → [PC Remote] before connecting the camera to the computer with a USB cable.

For details on how to use Imaging Edge, refer to the support page.

<http://www.sony.net/disoft/help/>

## Installing Imaging Edge on your computer

Download and install the software by accessing the following URL:

<http://www.sony.net/disoft/d/>

---

### Related Topic

- [USB Connection](#)

Interchangeable Lens Digital Camera  
ILCE-7M3 α7III

## Selecting a disc to be created

You can create a disc that can be played back on other devices from a movie recorded on this camera. What devices can play back the disc depends on the disc type. Select a disc type suitable for the playback devices you will be using.

Depending on the movie type, the movie format may be converted when creating a disc.



### High-definition image quality (HD) (Blu-ray Disc)

High-definition image quality (HD) movies can be recorded on a Blu-ray Disc, creating a high-definition image quality (HD) disc.

A Blu-ray Disc enables you to record longer-duration high-definition image quality (HD) movies than DVD discs.

Writable movie formats: XAVC S, AVCHD

Players: Blu-ray Disc playback devices (Sony Blu-ray Disc players, PlayStation 3, etc.)



### High-definition image quality (HD) (AVCHD recording disc)

High-definition image quality (HD) movies can be recorded on DVD media such as DVD-R discs, creating a high-definition image quality (HD) disc.

Writable movie formats: XAVC S, AVCHD

Players: AVCHD format playback devices (Sony Blu-ray Disc players, PlayStation 3, etc.)

You cannot play these kinds of discs on ordinary DVD players.



### Standard definition image quality (STD)

Standard definition image quality (STD) movies converted from high-definition image quality (HD) movies can be recorded on DVD media such as DVD-R discs, creating a standard image quality (STD) disc.

Writable movie formats: AVCHD

Players: Ordinary DVD playback devices (DVD players, computers that can play back DVD discs, etc.)

#### Hint

- You can use the following types of 12 cm discs with PlayMemories Home.  
**BD-R/DVD-R/DVD+R/DVD+R DL:** Non-rewritable  
**BD-RE/DVD-RW/DVD+RW:** Rewritable  
Additional recording is not possible.
- Always maintain your "PlayStation 3" to use the latest version of the "PlayStation 3" system software.

#### Note

- 4K movies cannot be recorded on a disc in 4K image quality.

#### Related Topic

- [Creating Blu-ray Discs from high-definition image quality movies](#)
- [Creating DVD discs \(AVCHD recording discs\) from high-definition image quality movies](#)

- [Creating DVD discs from standard image quality movies](#)

4-732-947-11(1) Copyright 2018 Sony Corporation



Interchangeable Lens Digital Camera  
ILCE-7M3 α7III

## Creating Blu-ray Discs from high-definition image quality movies

---

You can create Blu-ray Discs that can be played back on Blu-ray Disc playback devices (such as Sony Blu-ray Disc players or the PlayStation 3, etc.).

### A. How to create using a computer

With a Windows computer, you can copy movies imported to the computer and create Blu-ray Discs using PlayMemories Home.

Your computer must be able to create Blu-ray Discs.

When you create a Blu-ray Disc for the first time, connect your camera to the computer using a USB cable. The necessary software is automatically added to your computer. (An Internet connection is needed.)

For details on how to create a disc using PlayMemories Home, refer to the Help guide for PlayMemories Home.

### B. How to create using a device other than a computer

You can also create Blu-ray Discs using a Blu-ray recorder, etc.

For details, refer to the device's operating instructions.

#### Note

- When creating Blu-ray discs using PlayMemories Home from movies recorded in the XAVC S movie format, the image quality is converted to 1920×1080 (60i/50i). It is not possible to create discs with the original image quality. To record movies with the original image quality, copy movies to a computer or an external medium.

---

#### Related Topic

- [Selecting a disc to be created](#)
- [Creating DVD discs \(AVCHD recording discs\) from high-definition image quality movies](#)
- [Creating DVD discs from standard image quality movies](#)

Interchangeable Lens Digital Camera  
ILCE-7M3 α7III

## Creating DVD discs (AVCHD recording discs) from high-definition image quality movies

You can create DVD discs (AVCHD recording discs) that can be played back on AVCHD-compatible playback devices (such as Sony Blu-ray Disc players or the PlayStation 3, etc.).

### A. How to create using a computer

With a Windows computer, you can copy movies imported to the computer and create DVD discs (AVCHD recording discs) using PlayMemories Home.

Your computer must be able to create DVD discs (AVCHD recording discs).

When you create a DVD disc for the first time, connect your camera to the computer using a USB cable. The necessary software is automatically added to your computer. (An Internet connection is needed.)

For details on how to create a disc using PlayMemories Home, refer to the Help guide for PlayMemories Home.

### B. How to create using a device other than a computer

You can also create DVD discs (AVCHD recording discs) using a Blu-ray recorder, etc.

For details, refer to the device's operating instructions.

#### Note

- When creating DVD discs (AVCHD recording discs) using PlayMemories Home from movies recorded in the XAVC S movie format, the image quality is converted to 1920×1080 (60i/50i). It is not possible to create discs with the original image quality. To record movies with the original image quality, copy movies to a computer or an external medium.
- When creating AVCHD recording discs using PlayMemories Home from movies recorded in the AVCHD movie format with [Record Setting] set to [60i 24M(FX)]/[50i 24M(FX)], the image quality is converted and it is not possible to create discs with the original image quality. This conversion can take a long time. To record movies with the original image quality, use a Blu-ray Disc.

#### Related Topic

- [Selecting a disc to be created](#)
- [Creating Blu-ray Discs from high-definition image quality movies](#)
- [Creating DVD discs from standard image quality movies](#)

Interchangeable Lens Digital Camera  
ILCE-7M3 α7III

## Creating DVD discs from standard image quality movies

---

You can create DVD discs that can be played back on ordinary DVD playback devices (DVD players, computers that can play back DVD discs, etc.).

### A. How to create using a computer

With a Windows computer, you can copy movies imported to the computer and create DVD disc using PlayMemories Home.

Your computer must be able to create DVD discs.

When you create a DVD disc for the first time, connect your camera to the computer using a USB cable. Install the dedicated add-on software following the on-screen instructions. (An internet connection is needed.)

For details on how to create a disc using PlayMemories Home, refer to the Help for PlayMemories Home.

### B. How to create using a device other than a computer

You can also create DVD discs using a Blu-ray recorder, HDD recorder, etc.

For details, refer to the device's operating instructions.

---

### Related Topic

- [Selecting a disc to be created](#)
- [Creating Blu-ray Discs from high-definition image quality movies](#)
- [Creating DVD discs \(AVCHD recording discs\) from high-definition image quality movies](#)

Interchangeable Lens Digital Camera  
ILCE-7M3 α7III

## Using MENU items

You can change settings related to all the camera operations including shooting, playback, and operating method. You can also execute camera functions from the MENU.

- 1 Press the MENU button to display the menu screen.

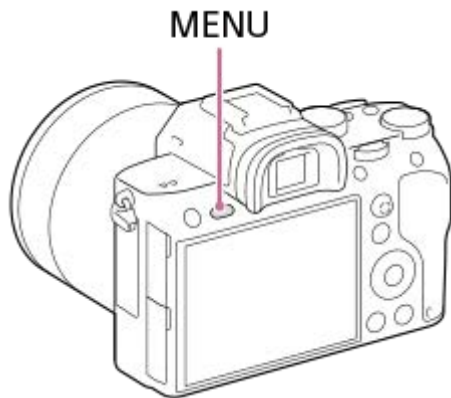

- 2 Select the desired setting you want to adjust using the top/bottom/left/right sides of the control wheel or by turning the control wheel, and then press the center of the control wheel.

- Select an icon at the top of the screen (A) and press the left/right side of the control wheel to move to another MENU item.
- You can go back to the previous screen by pressing the MENU button (B).

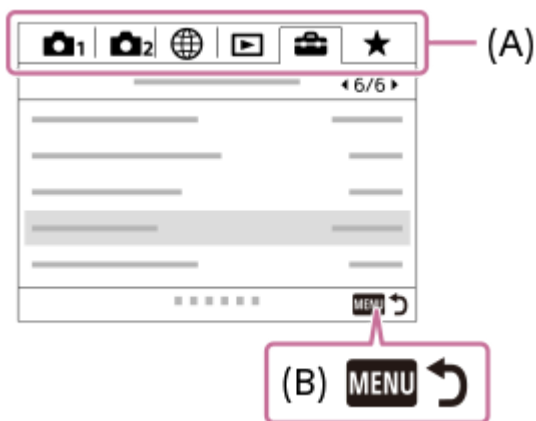

- 3 Select the desired setting value, and press the center to confirm your selection.

### Related Topic



- [Add Item](#)

Interchangeable Lens Digital Camera  
ILCE-7M3 α7III

## File Format (still image)

---

Sets the file format for still images.

1 MENU →  1 (Camera Settings1) → [ File Format] → desired setting.

### Menu item details

#### RAW:

Images before processing are recorded in this file format. Select this format to process images on a computer for professional purposes.



#### RAW & JPEG:

A RAW image and a JPEG image are created at the same time. This is suitable when you need two image files, a JPEG for viewing, and a RAW for editing.

#### JPEG:

The image is recorded in the JPEG format.

### About RAW images

- To open a RAW image file recorded with this camera, the software Imaging Edge is needed. With Imaging Edge, you can open a RAW image file, then convert it into a popular image format such as JPEG or TIFF, or readjust the white balance, saturation or contrast of the image.
- You cannot apply [Auto HDR] or [Picture Effect] functions with RAW images.
- RAW images recorded with this camera have a resolution of 14 bits per pixel. However, resolution is limited to 12 bits in the following shooting modes:
  - [ Long Exposure NR]
  - [BULB]
  - [Cont. Shooting] when [ RAW File Type] is set to [Compressed]
- You can set whether RAW images are compressed or uncompressed using [ RAW File Type].

#### Note

- If you do not intend to edit the images on your computer, we recommend that you record in JPEG format.
- You cannot add DPOF (print order) registration marks to RAW images.

---

### Related Topic



- [JPEG Image Size \(still image\)](#)
- [RAW File Type \(still image\)](#)

Interchangeable Lens Digital Camera  
ILCE-7M3 α7III

## RAW File Type (still image)

---

Selects the file type for RAW images.

1 MENU →  1 (Camera Settings1) → [ RAW File Type] → desired setting.

### Menu item details



#### Compressed:

Records images in compressed RAW format.

#### Uncompressed:

Records images in uncompressed RAW format. When [Uncompressed] is selected for [ RAW File Type], the file size of the image will be larger than if it were recorded in compressed RAW format.

#### Note



- When [Uncompressed] is selected for [ RAW File Type], the icon on the screen switches to  .  is also displayed while an image shot in uncompressed RAW format is played back.

Interchangeable Lens Digital Camera  
ILCE-7M3 α7III

## JPEG Quality (still image)

---

Selects the JPEG image quality when [ File Format] is set to [RAW & JPEG] or [JPEG].

**1** MENU →  1 (Camera Settings1) → [ JPEG Quality] → **desired setting.**

### Menu item details

#### Extra fine/Fine/Standard:

Since the compression rate increases from [Extra fine] to [Fine] to [Standard], the file size decreases in the same order. This allows more files to be recorded on one memory card, but the image quality is lower.

---



### Related Topic

- [File Format \(still image\)](#)

Interchangeable Lens Digital Camera  
ILCE-7M3 α7III

## JPEG Image Size (still image)

The larger the image size, the more detail will be reproduced when the image is printed on large-format paper. The smaller the image size, the more images can be recorded.

1 MENU →  (Camera Settings1) → [ JPEG Image Size] → desired setting.

### Menu item details

When [  Aspect Ratio] is set to 3:2	
L: 24M	6000×4000 pixels
M: 10M	3936×2624 pixels
S: 6.0M	3008×2000 pixels

When [  Aspect Ratio] is set to 16:9	
L: 20M	6000×3376 pixels
M: 8.7M	3936×2216 pixels
S: 5.1M	3008×1688 pixels

### When recording in the APS-C-equivalent size

When [  Aspect Ratio] is set to 3:2	
L: 10M	3936×2624 pixels
M: 6.0M	3008×2000 pixels
S: 2.6M	1968×1312 pixels

When [  Aspect Ratio] is set to 16:9	
L: 8.7M	3936×2216 pixels
M: 5.1M	3008×1688 pixels
S: 2.2M	1968×1112 pixels

#### Note

- When [ File Format] is set to [RAW] or [RAW & JPEG], the image size for RAW images corresponds to "L."





- Aspect Ratio (still image)

4-732-947-11(1) Copyright 2018 Sony Corporation

Interchangeable Lens Digital Camera  
ILCE-7M3 α7III

## Aspect Ratio (still image)

---

① MENU →  1 (Camera Settings1) → [ Aspect Ratio] → desired setting.

### Menu item details

**3:2:**

Same aspect ratio as 35 mm plate film

**16:9:**

An aspect ratio suitable for viewing on a TV that supports high definition

Interchangeable Lens Digital Camera  
ILCE-7M3 α7III

## APS-C/Super 35mm

Sets whether to record in APS-C-equivalent size for still images and in Super 35mm-equivalent size for movies. You can use an APS-C-size dedicated lens with this product by recording in an APS-C-equivalent size or Super 35 mm-equivalent size.

1 MENU →  1 (Camera Settings1) → [APS-C/Super 35mm] → desired setting.

### Menu item details

#### APS-C S35 Shooting:

Sets whether the camera automatically determines the capture range based on the lens. (Auto/Manual)

#### APS-C S35 Shoot.: Manual:

Sets whether to record in either an APS-C-equivalent size or Super 35mm-equivalent size when [ APS-C S35 Shooting] is set to [Manual]. (Off/On)



#### Note

- If you try to perform full-frame shooting with an APS-C-compatible lens attached, you may not achieve the desired shooting results.
- When APS-C/Super 35 mm shooting is activated, the central part of the image sensor is used and the angle of view is equivalent to that of an APS-C-size image sensor.

Interchangeable Lens Digital Camera  
ILCE-7M3 α7III

## Long Exposure NR (still image)

When you set the shutter speed to 1 second(s) or longer (long exposure shooting), noise reduction is turned on for the duration that the shutter is open. With the function turned on, the grainy noise typical of long exposures is reduced.



1 MENU →  1 (Camera Settings1) → [ Long Exposure NR] → desired setting.

### Menu item details

**On:**  
Activates noise reduction for the same duration that the shutter is open. When noise reduction is in progress, a message appears and you cannot take another picture. Select this to prioritize the image quality.

**Off:**  
Does not activate noise reduction. Select this to prioritize the timing of shooting.



#### Note

- Noise reduction may not be activated even if [ Long Exposure NR] is set to [On] in the following situations:
  - [Drive Mode] is set to [Cont. Shooting] or [Cont. Bracket].
  - The shooting mode is set to [Scene Selection] and [Sports Action] is selected.
- [ Long Exposure NR] cannot be set to [Off] in the following shooting modes:
  - [Intelligent Auto]
  - [Scene Selection]
- Depending on the shooting conditions, the camera may not perform noise reduction, even if the shutter speed is 1 second(s) or longer.

Interchangeable Lens Digital Camera  
ILCE-7M3 α7III

## High ISO NR (still image)

When shooting with high ISO sensitivity, the product reduces noise that becomes more noticeable when the product sensitivity is high.

1 MENU →  1 (Camera Settings1) → [ High ISO NR] → desired setting.

### Menu item details

**Normal:**

Activates high ISO noise reduction normally.





**Low:**

Activates high ISO noise reduction moderately.

**Off:**

Does not activate high ISO noise reduction. Select this to prioritize the timing of shooting.



**Note**

- [ High ISO NR] is not available in the following shooting modes:
  - [Intelligent Auto]
  - [Scene Selection]
- When [ File Format] is set to [RAW], this function is not available.
- [ High ISO NR] does not work for RAW images when the [ File Format] is [RAW & JPEG].

Interchangeable Lens Digital Camera  
ILCE-7M3 α7III

## Color Space (still image)

The way colors are represented using combinations of numbers or the range of color reproduction is called “color space.” You can change the color space depending on the purpose of the image.

1 MENU →  (Camera Settings1) → [ Color Space] → desired setting.

### Menu item details

#### sRGB:

This is the standard color space of the digital camera. Use [sRGB] in normal shooting, such as when you intend to print out the images without any modification.

#### AdobeRGB:

This color space has a wide range of color reproduction. When a large part of the subject is vivid green or red, Adobe RGB is effective. The file name of the recorded image starts with “\_.”

#### Note

- [AdobeRGB] is for applications or printers that support color management and DCF2.0 option color space. Images may not be printed or viewed in the correct colors if you use applications or printers that do not support Adobe RGB.
- When displaying images that were recorded with [AdobeRGB] on non-Adobe RGB-compliant devices, the images will be displayed with low saturation.

Interchangeable Lens Digital Camera  
ILCE-7M3 α7III

## Lens Comp.

Compensates for shading in the corners of the screen or distortion of the screen, or reduces color deviation at the corners of the screen caused by certain lens characteristics.

1 MENU →  (Camera Settings1) → [Lens Comp.] → desired setting.

### Menu item details

#### Shading Comp.:

Sets whether to automatically compensate for darkness in the corners of the screen. ([Auto]/[Off])

#### Chro. Aber. Comp.:

Sets whether to automatically reduce color deviation at the corners of the screen. ([Auto]/[Off])

#### Distortion Comp.:

Sets whether to automatically compensate for distortion of the screen. ([Auto]/[Off])

#### Note

- This function is only available when using an automatic compensation compliant lens.
- Darkness in the corners of the screen may not be corrected with [Shading Comp.], depending on the lens type.
- Depending on the attached lens, [Distortion Comp.] is fixed to [Auto], and you cannot select [Off].

Interchangeable Lens Digital Camera  
ILCE-7M3 α7III

## Scene Selection

---

Allows you to shoot with preset settings according to the scene.

- 1 Set the mode dial to SCN (Scene Selection).
- 2 Turn the front dial to select the desired setting.

### Menu item details

#### **Portrait:**

Blurs background and sharpens the subject. Accentuates the skin tones softly.



#### **Sports Action:**

Shoots a moving subject at a fast shutter speed so that the subject looks as if it is standing still. The product shoots images continuously while the shutter button is pressed.



#### **Macro:**

Shoots close-ups of the subjects, such as flowers, insects, food, or small items.



#### **Landscape:**

Shoots the entire range of a scenery in sharp focus with vivid colors.



#### **Sunset:**

Shoots the red of the sunset beautifully.





### Night Scene:

Shoots night scenes without losing the dark atmosphere.



### Night Portrait:

Shoots night scene portraits using the flash (sold separately).



#### Hint

- To change the scene, rotate the front dial on the shooting screen and select a new scene.

#### Note

- Under the following settings, the shutter speed is slower, so use of a tripod, etc. is recommended to prevent the image from blurring:
  - [Night Scene]
  - [Night Portrait]
- The minimum distance that you can come close to a subject does not change even if you select [Macro]. For the minimum in-focus range, refer to the minimum distance of the lens attached to the product.

---



#### Related Topic

- [Using flash \(sold separately\)](#)

Interchangeable Lens Digital Camera  
ILCE-7M3 α7III

## Drive Mode

Select the appropriate mode for the subject, such as single shooting, continuous shooting or bracketing shooting.

- 1 Select  /  (Drive Mode) on the control wheel → desired setting.
  - You can also set the drive mode by selecting MENU →  1 (Camera Settings1) → [Drive Mode].
- 2 Select the desired mode using the right/left side of the control wheel.

### Menu item details

#### Single Shooting:

Normal shooting mode.

#### Cont. Shooting:

Shoots images continuously while you press and hold down the shutter button.

#### Self-timer:

Shoots an image using the self-timer after a designated number of seconds have elapsed since the shutter button was pressed.

#### Self-timer(Cont):

Shoots a designated number of images using the self-timer after a designated number of seconds have elapsed since the shutter button was pressed.

#### BRK C Cont. Bracket:

Shoots images while holding the shutter button down, each with different degrees of exposure.

#### BRK S Single Bracket:

Shoots a specified number of images, one by one, each with a different degrees of exposure.

#### BRK WB WB bracket:

Shoots a total of three images, each with different color tones according to the selected settings for white balance, color temperature and color filter.

#### BRK DRO DRO Bracket:

Shoots a total of three images, each at a different degree of D-Range Optimizer.

#### Note

- When the shooting mode is set to [Scene Selection] and [Sports Action] is selected, [Single Shooting] cannot be performed.

### Related Topic





- [Cont. Shooting](#)
- [Self-timer](#)
- [Self-timer\(Cont\)](#)
- [Cont. Bracket](#)
- [Single Bracket](#)
- [WB bracket](#)
- [DRO Bracket](#)

Interchangeable Lens Digital Camera  
ILCE-7M3 α7III

## Bracket Settings

---

You can set the self-timer in bracket shooting mode, and the shooting order for exposure bracketing and white balance bracketing.

- 1 Select  /  (Drive Mode) of the control wheel → select bracket shooting mode.
  - You can also set the drive mode by selecting MENU →  1 (Camera Settings1) → [Drive Mode].
- 2 MENU →  1 (Camera Settings1) → [Bracket Settings] → desired setting.

### Menu item details

#### Selftimer during Brkt:

Sets whether to use the self-timer during bracket shooting. Also sets the number of seconds until the shutter is released if using the self-timer.

(OFF/2 Sec/5 Sec/10 Sec)

#### Bracket order:

Sets the order of exposure bracketing and white balance bracketing.

(0→-→+/-→0→+)



---

### Related Topic

- [Cont. Bracket](#)
- [Single Bracket](#)
- [WB bracket](#)
- [DRO Bracket](#)



Interchangeable Lens Digital Camera  
ILCE-7M3 α7III

## Recall (Camera Settings1/Camera Settings2)

Allows you to shoot an image after recalling often-used modes or camera settings registered with [**MR** 1/2 Memory] in advance.

**1** Set the mode dial to 1, 2 (Memory recall).



**2** Press the center of the control wheel to confirm.

- You can also recall registered modes or settings by selecting MENU → 1 (Camera Settings1) → [**MR** 1/2 Recall].

### Hint

- To recall settings registered to the memory card, set the mode dial to 1, 2 (Memory recall), then select the desired number by pressing the left/right side of the control wheel.
- If you recall settings registered to the memory card, the settings are recalled from the memory card in the slot specified in [**MR** Select Media]. You can confirm the memory card slot by selecting MENU → 1 (Camera Settings1) → [**MR** Select Media].
- Settings registered to a memory card using another camera of the same model name can be recalled with this camera.

### Note

- If you set [**MR** 1/2 Recall] after completing the shooting settings, the registered settings are given priority and the original settings may become invalid. Check the indicators on the screen before shooting.

### Related Topic

- [Memory \(Camera Settings1/Camera Settings2\)](#)

Interchangeable Lens Digital Camera  
ILCE-7M3 α7III

## Memory (Camera Settings1/Camera Settings2)

Allows you to register up to 2 often-used modes or product settings to the product and up to 4 (M1 through M4) to the memory card. You can recall the settings using just the mode dial.

- 1 Set the product to the setting you want to register.
- 2 MENU →  1 (Camera Settings1) → [   1 /  2 Memory ] → desired number.
- 3 Press the center of the control wheel to confirm.

### Items that can be registered

- You can register various functions for shooting. The items that can actually be registered are displayed on the menu of the camera.
- Aperture (F number)
- Shutter speed

### To change registered settings

Change the setting to the desired one and re-register the setting to the same mode number.

#### Note

- M1 through M4 can be selected only when a memory card is inserted into the product.
- When registering the settings on a memory card, only a memory card that has been selected using [  Select Media ] can be used.
- Program Shift cannot be registered.

### Related Topic

- [Recall \(Camera Settings1/Camera Settings2\)](#)

Interchangeable Lens Digital Camera  
ILCE-7M3 α7III

## Select Media (Memory recall)

---

Selects the memory card slot from which settings are recalled or to which settings are registered for M1 through M4.

**1** MENU →  1 (Camera Settings1) → [ **MR** Select Media ] → desired slot.

### Menu item details

**Slot 1:**

Selects the slot 1.

**Slot 2:**

Selects the slot 2.

Interchangeable Lens Digital Camera  
ILCE-7M3 α7III

## Registering shooting settings to a custom key (Reg Cust Shoot Set)

You can register shooting settings (such as exposure, focus setting, drive mode, etc.) to a custom key in advance and temporarily recall them while holding down the key. Simply press the custom key to switch the settings quickly and release the key to go back to the original settings. This function is useful when recording active scenes such as sports.

- 1 MENU →  1 (Camera Settings1) → [Reg Cust Shoot Set] → Select a registration number from [Recall Custom hold 1] to [Recall Custom hold 3].**

The setting screen for the selected number will be displayed.

- 2 Using the top/bottom/left/right side of the control wheel, select the check boxes for the functions that you want to recall with one of the registration numbers and press the center to check each box.**

A  mark will be displayed in the boxes for the functions.

- To cancel a selection, press the center again.

- 3 Select the function that you want to adjust using the top/bottom/left/right side of the control wheel, and press the center to adjust the function to the desired setting.**



- Select [Import Current Setting] to register the current settings of the camera to the registration number that you chose.

- 4 Select [Register].**

### Items that can be registered

- You can register various functions for shooting. The items that can actually be registered are displayed on the menu of the camera.
- Exposure
- Focus setting
- Drive mode (other than self-timer)

### To recall registered settings

1. MENU →  2 (Camera Settings2) → [ Custom Key] → Select the desired key and then select one of the registration numbers from [Recall Custom hold 1] to [Recall Custom hold 3].
2. On the shooting screen, press the shutter button while holding down the key to which you assigned one of the registration numbers.  
The registered settings are activated while you are holding down the custom key.

#### Hint

- You can change the settings for [Reg Cust Shoot Set] after assigning one of the registration numbers to the custom key using [ Custom Key].

#### Note

- The registration numbers [Recall Custom hold 1] through [Recall Custom hold 3] are available only when the shooting mode is set to P/A/S/M.
- Depending on the attached lens and the status of the camera when the registered setting recall is executed, the registered settings may not take effect.

---

---

## Related Topic

- [Custom Key \(still image/movie/playback\)](#)

4-732-947-11(1) Copyright 2018 Sony Corporation



Interchangeable Lens Digital Camera  
ILCE-7M3 α7III

## Focus Mode

Selects the focus method to suit the movement of the subject.

1 MENU →  1 (Camera Settings1) → [Focus Mode] → desired setting.

### Menu item details

#### **AF-S** (Single-shot AF):

The product locks the focus once focusing is complete. Use this when the subject is motionless.

#### **AF-A** (Automatic AF):

[Single-shot AF] and [Continuous AF] are switched according to the movement of the subject. When the shutter button is pressed halfway down, the product locks the focus when it determines that the subject is motionless, or continues to focus when the subject is in motion. During continuous shooting, the product automatically shoots with Continuous AF from the second shot.

#### **AF-C** (Continuous AF):

The product continues to focus while the shutter button is pressed and held halfway down. Use this when the subject is in motion. In [Continuous AF] mode, there is no beep when the camera focuses.

#### **DMF** (DMF):

You can make fine adjustments manually after performing auto focusing, letting you focus on a subject more quickly than when using the manual focus from the beginning. This is convenient in situations such as macro shooting.

#### **MF** (Manual Focus):

Adjusts the focus manually. If you cannot focus on the intended subject using auto focus, use manual focus.

### Focus indicator

 (lit):

The subject is in focus and the focus is locked.

 (flashing):

The subject is not in focus.

 (lit):

The subject is in focus. The focus will be adjusted continuously according to the movements of the subject.

 (lit):

Focusing is in progress.

### Subjects on which it is difficult to focus using auto focus

- Dark and distant subjects
- Subjects with poor contrast
- Subjects seen through glass
- Fast-moving subjects
- Reflective light or shiny surfaces
- Flashing light
- Back-lit subjects
- Continuously repetitive patterns, such as the facades of buildings
- Subjects in the focusing area with different focal distances

#### Hint

- In [Continuous AF] mode, you can lock the focus by pressing and holding the button that has been assigned the [Focus Hold] function.
- When you set the focus to infinity in the manual focus mode or the direct manual focus mode, make sure that the focus is on a sufficiently distant subject by checking the monitor or the viewfinder.

## Note

- [Automatic AF] is available only when you are using a lens that supports phase detection AF.
- When [Continuous AF] or [Automatic AF] is set, the angle of view may change little by little while focusing. This does not affect the actual recorded images.
- Only [Continuous AF] and [Manual Focus] are available when shooting movies or when the mode dial is set to **S&Q**.

---

## Related Topic

- [Direct manual focus \(DMF\)](#)
- [Manual Focus](#)
- [MF Assist \(still image\)](#)
- [Phase detection AF](#)

Interchangeable Lens Digital Camera  
ILCE-7M3 α7III

## Priority Set in AF-S

---

Sets whether to release the shutter even if the subject is not in focus when [Focus Mode] is set to [Single-shot AF], [DMF] or [Automatic AF] and the subject is remaining still.

1 MENU →  (Camera Settings1) → [Priority Set in AF-S] → desired setting.

### Menu item details

**AF:**

Prioritizes focusing. The shutter will not be released until the subject is in focus.

**Release:**

Prioritizes the shutter's release. The shutter will be released even if the subject is out of focus.

**Balanced Emphasis:**

Shoots with a balanced emphasis on both focusing and shutter release.

---

### Related Topic

- [Focus Mode](#)
- [Priority Set in AF-C](#)

Interchangeable Lens Digital Camera  
ILCE-7M3 α7III

## Priority Set in AF-C

---

Sets whether to release the shutter even if the subject is not in focus when the continuous AF is activated and the subject is in motion.

1 MENU →  1 (Camera Settings1) → [Priority Set in AF-C] → desired setting.

### Menu item details

**AF:**

Prioritizes focusing. The shutter will not be released until the subject is in focus.

**Release:**

Prioritizes the shutter's release. The shutter will be released even if the subject is out of focus.

**Balanced Emphasis:**

Shoots with a balanced emphasis on both focusing and shutter release.

---

### Related Topic

- [Focus Mode](#)
- [Priority Set in AF-S](#)

Interchangeable Lens Digital Camera  
ILCE-7M3 α7III

## Focus Area

Selects the focusing area. Use this function when it is difficult to focus properly in the auto focus mode.

1 MENU →  1 (Camera Settings1) → [Focus Area] → desired setting.

### Menu item details

#### Wide :

Focuses on a subject covering the whole range of the screen automatically. When you press the shutter button halfway down in the still image shooting mode, a green frame is displayed around the area that is in focus.

#### Zone :

Select a zone on the monitor on which to focus, and the product will automatically select a focus area.

#### Center :

Focuses automatically on a subject in the center of the image. Use together with the focus-lock function to create the composition you want.

#### Flexible Spot :

Allows you to move the focusing frame to a desired point on the screen and focus on an extremely small subject in a narrow area.

#### Expand Flexible Spot :

If the product cannot focus on a single selected point, it uses focus points around the flexible spot as a secondary priority area for focusing.

#### Lock-on AF :

When the shutter button is pressed and held halfway down, the product tracks the subject within the selected autofocus area. This setting is available only when the [Focus Mode] is set to [Continuous AF]. Point the cursor at [Lock-on AF] on the [Focus Area] setting screen, and then select the desired area to start tracking using the left/right sides of the control wheel. You can also move the tracking start area to the desired point by designating the area as a zone, flexible spot or expand flexible spot.

### Examples of the focusing frame display

The focusing frame differs as follows.

#### When focusing on a larger area

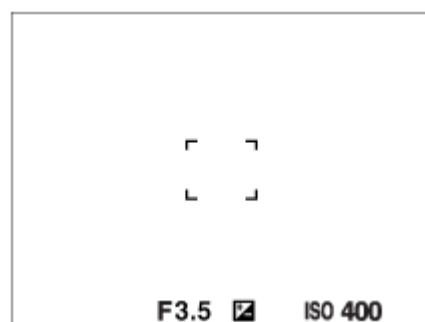

#### When focusing on a smaller area

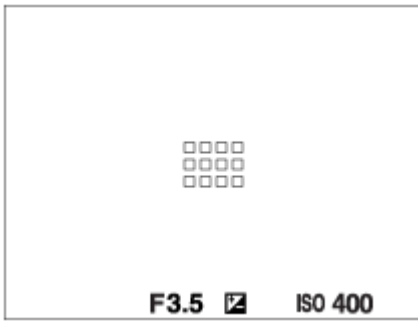

- When [Focus Area] is set to [Wide] or [Zone], the focusing frame may switch between “When focusing on a larger area” and “When focusing on a smaller area” depending on the subject or situation.
- When you attach an A-mount lens with a Mount Adaptor (LA-EA1 or LA-EA3) (sold separately) and [AF System] is set to [Phase Detection AF], the focusing frame for “When focusing on a smaller area” may be displayed.

### When focus is achieved automatically based on the whole range of the monitor

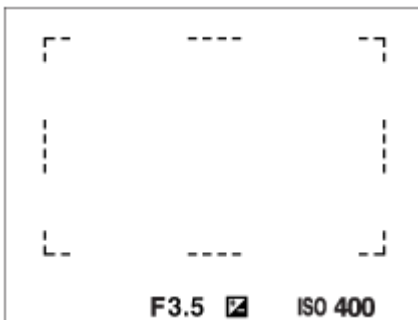

- When you use a zoom function other than the optical zoom, the [Focus Area] setting is disabled and the focusing frame is shown by the dotted line. The AF operates with priority on and around the center area.

### To move the focus area

- You can move the focus area in [Flexible Spot], [Expand Flexible Spot], or [Zone] by operating the multi-selector. If you assign [Focus Standard] to the center of the multi-selector beforehand, you can move the focusing frame back to the center of the monitor by pressing the center of the multi-selector.
- You can move the focusing frame quickly by touching and dragging it on the monitor. Set [Touch Operation] to [On] beforehand.

#### Hint

- In the default settings, [Focus Area] is assigned to the C2 button.

#### Note

- [Focus Area] is locked to [Wide] in the following situations:
  - [Intelligent Auto]
  - [Scene Selection]
- The focus area may not light up during continuous shooting or when the shutter button is pressed all the way down at once.
- When the mode dial is set to (Movie) or **S&Q** or during movie shooting, [Lock-on AF] cannot be selected as the [Focus Area].

### Related Topic

- [Touch Operation](#)
- [Adjusting the focus area settings to the camera's orientation \(horizontal/vertical\) \(Sw. V/H AF Area\)](#)

- [Registering the current focus area \(AF Area Regist.\) \(still image\)](#)

4-732-947-11(1) Copyright 2018 Sony Corporation

Interchangeable Lens Digital Camera  
ILCE-7M3 α7III

## Focus Settings

---

Configures the focus functions using the front dial/rear dial or the control wheel.

- 1 MENU →  1 (Camera Settings1) → [Focus Settings].
- 2 Perform settings using the front/rear dial or control wheel.

### When the focus mode is set to auto focus or Direct Manual Focus

You can adjust the focus area settings and the position of the focusing frame. The focusing frame can be moved only when the [Focus Area] is set to the following:

- [Zone]
- [Flexible Spot]
- [Expand Flexible Spot]

**Front dial:** Moves the focusing frame up/down.

**Rear dial:** Moves the focusing frame right/left.

**Control wheel:** Selects the focus area.

### When the focus mode is set to Manual Focus

You can set the area to be magnified when focusing manually.

**Front dial:** Moves the area to be magnified up/down.

**Rear dial:** Moves the area to be magnified right/left.



**Control wheel:** Moves the area to be magnified up/down.



Interchangeable Lens Digital Camera  
ILCE-7M3 α7III

## Adjusting the focus area settings to the camera's orientation (horizontal/vertical) (Sw. V/H AF Area)

You can set whether to switch the [Focus Area] and the position of the focusing frame according to the orientation of the camera (horizontal/vertical). This function is useful when shooting scenes for which you have to change the camera position frequently, such as portraits or sports scenes.

1 MENU →  (Camera Settings1) → [ Swt. V/H AF Area] → desired setting.

### Menu item details

#### Off:

Does not switch the [Focus Area] and the position of the focusing frame according to the orientation of the camera (horizontal/vertical).

#### AF Point Only:

Switches the position of the focusing frame according to the orientation of the camera (horizontal/vertical). The [Focus Area] is fixed.

#### AF Point + AF Area:

Switches both the [Focus Area] and the position of the focusing frame according to the orientation of the camera (horizontal/vertical).



### An example when [AF Point + AF Area] is selected



- (A) Vertical: [Flexible Spot] (Upper left corner)  
 (B) Horizontal: [Flexible Spot] (Upper right corner)  
 (C) Vertical: [Zone] (Lower left corner)

- Three camera orientations are detected: horizontal, vertical with the side of the shutter button facing up, and vertical with the side of the shutter button facing down.

### Note

- If the setting for [ Swt. V/H AF Area] is changed, the focus settings for each camera orientation will not be retained.
- The [Focus Area] and the position of the focusing frame will not change even when [ Swt. V/H AF Area] is set to [AF Point + AF Area] or [AF Point Only] in the following situations:
  - When the shooting mode is set to [Intelligent Auto], [Movie], or [S&Q Motion]
  - While the shutter button is pressed halfway down
  - During movie shooting
  - While using the digital zoom function
  - While the auto-focusing is activated
  - When [Focus Settings] are activated
  - During continuous shooting
  - During the countdown for the self-timer
  - When [Focus Magnifier] is activated

- When you shoot images right after the power is turned on and the camera is vertical, the first shot is taken with the horizontal focus setting or with the last focus setting.
- The orientation of the camera cannot be detected when the lens is facing up or down.

---

---

### Related Topic



- [Focus Area](#)

4-732-947-11(1) Copyright 2018 Sony Corporation

Interchangeable Lens Digital Camera  
ILCE-7M3 α7III

## AF Illuminator (still image)

The AF illuminator supplies fill light to focus more easily on a subject in dark surroundings. In the time between pressing the shutter button halfway down and locking the focus, the red AF illuminator lights up to allow the camera to focus easily.

1 MENU →  1 (Camera Settings1) → [ AF Illuminator] → desired setting.

### Menu item details



#### Auto:

The AF illuminator lights up automatically in dark surroundings.

#### Off:

Does not use the AF illuminator.

#### Note

- You cannot use [ AF Illuminator] in the following situations:
  - When the shooting mode is [Movie] or [S&Q Motion].
  - When [Focus Mode] is set to [Continuous AF] or [Automatic AF] and the subject is moving (when the focus indicator  or  lights up).
  - When [Focus Magnifier] is activated.
  - When [Scene Selection] is set to the following modes:
    - [Landscape]
    - [Sports Action]
    - [Night Scene]
  - When a Mount Adaptor is attached.
- If the Multi Interface Shoe is equipped with a flash with an AF illuminator function, when the flash is turned on, the AF illuminator will turn on as well.
- The AF illuminator emits a very bright light. Although there is no health hazard, do not look directly into the AF illuminator at close range.

Interchangeable Lens Digital Camera  
ILCE-7M3 α7III

## Center Lock-on AF

When you press the center of the control wheel, the camera detects the subject positioned in the center of the screen and continues to track the subject.

1 MENU →  (Camera Settings1) → [Center Lock-on AF] → [On].

2 Align the target frame (A) over the subject and press the center of the control wheel.

- Press the center again to stop tracking.

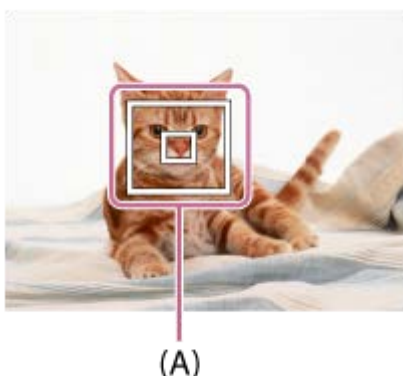



3 Press the shutter button fully down to shoot the image.

### Hint

- If you assign the [Focus Standard] function to the key of your choice, you can activate [Center Lock-on AF] or detect a subject again by pressing the key when [Focus Area] is set to [Wide] or [Center].
- You can select the subject to be tracked by touch operation when shooting using the monitor. Set [Touch Operation] to [On], and select [Touch Panel+Pad] or [Touch Panel Only] under [Touch Panel/Pad].

### Note

- The [Center Lock-on AF] function may not function very well in the following situations:
  - The subject is moving too quickly.
  - The subject is too small, or too large.
  - The contrast between the subject and the background is poor.
  - It is dark.
  - The ambient light changes.
- Lock-on AF does not work in the following situations:
  - When shooting in Manual Focus mode.
  - When using the digital zoom
  - When shooting movies with [  Record Setting] set to [120p]/[100p]
  - When shooting slow/quick motion movies with [  Frame Rate] set to [120fps]/[100fps].



Interchangeable Lens Digital Camera  
ILCE-7M3 α7III

## Set. Face Prty in AF

Sets whether the camera focuses on detected faces with higher priority in the auto-focus mode.

1 MENU →  (Camera Settings1) → [Set. Face Prty in AF] → [Face Priority in AF] → desired setting.

### Menu item details

#### On:

The camera focuses on detected faces with higher priority.

#### Off:

The camera focuses without face detection.

### Face Dtct Frame Dsp

Sets whether to display the face detection frame when [Face Priority in AF] is set to [On].

1. MENU →  (Camera Settings1) → [Set. Face Prty in AF] → [Face Dtct Frame Dsp] → desired setting.

#### On:

Displays the face detection frame when [Face Priority in AF] is set to [On].

#### Off:

Does not display the face detection frame.

### Face Detection frame

- When the product detects a face, the gray face detection frame appears. When the product determines that autofocus is enabled, the face detection frame turns white.
- In case you have registered the priority order for each face using [Face Registration], the product automatically selects the first prioritized face and the face detection frame over that face turns white. The face detection frames of other registered faces turn reddish-purple.

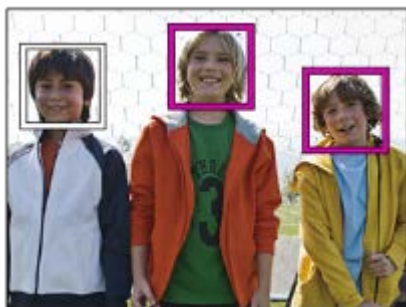



#### Hint

- When [Set. Face Prty in AF] is set to [On] and the focus mode is set to [Single-shot AF], a detection frame is displayed over the eyes when the camera focuses on eyes. The frame displayed over the eyes will disappear after a period of time.

#### Note

- You cannot use the face detection function with the following functions:
  - Other zoom functions than the optical zoom
  - [Posterization] under [Picture Effect]
  - [Focus Magnifier]

- Movie shooting with [  Record Setting] set to [120p]/[ 100p].
- When [  Frame Rate] is set to [120fps]/[100fps] during slow-motion/quick-motion shooting.
- Up to 8 faces of your subjects can be detected.
- Even if [Face Dtct Frame Dsp] is set to [Off], a green focusing frame will be displayed over faces that are in focus.
- When the shooting mode is set to [Intelligent Auto], [Face Priority in AF] is locked to [On].
- The product may not detect faces at all or may accidentally detect other objects as faces in some conditions.

---

### Related Topic



- [Face Registration \(New Registration\)](#)
- [Face Registration \(Order Exchanging\)](#)

Interchangeable Lens Digital Camera  
ILCE-7M3 α7III

## AF Track Sens (still image)

---

You can select the AF track sensitivity when the subject goes out of focus in still image mode.

**1** MENU →  1 (Camera Settings1) → [ AF Track Sens] → **desired setting.**

### Menu item details

**5(Responsive) / 4 / 3(Standard) / 2 / 1(Locked on):**

Select [5(Responsive)] to focus responsively on subjects at different distances.



Select [1(Locked on)] to keep the focus on a specific subject when other things are crossing in front of the subject.



Interchangeable Lens Digital Camera  
ILCE-7M3 α7III

## AF System (still image)

Sets the focus detection system (Phase Detection AF/Contrast AF) when you attach an A-mount lens using an LA-EA1/LA-EA3 Mount Adaptor (sold separately).

1 MENU →  1 (Camera Settings1) →  AF System → desired setting.

### Menu item details



#### Phase Detection AF:

Focuses with Phase Detection AF. The focusing speed is very fast.

#### Contrast AF:

Always focuses with Contrast AF. The focusing speed is slower. Use when you cannot focus with [Phase Detection AF].

#### Note



- When [ AF System] is set to [Contrast AF], [Continuous AF] under [Focus Mode] is unavailable.
- The following functions are unavailable when [ AF System] is set to [Phase Detection AF]:
  - [Zone], [Expand Flexible Spot], and [Lock-on AF] in [Focus Area]
  - [Center Lock-on AF]
- When [ AF System] is set to [Phase Detection AF], [Priority Set in AF-S] will temporarily switch to [AF] even if it is set to [Balanced Emphasis].

Interchangeable Lens Digital Camera  
ILCE-7M3 α7III

## AF w/ shutter (still image)

---

Selects whether to focus automatically when you press the shutter button halfway down. Select [Off] to adjust the focus and the exposure separately.

1 MENU →  1 (Camera Settings1) → [ AF w/ shutter] → desired setting.

### Menu item details

#### On:





The auto focus operates when you press the shutter button halfway down.

#### Off:

The auto focus does not operate even if you press the shutter button halfway down.

### Useful method to micro-adjust the focus

When an A-mount lens is attached, activating the auto focus function with a button other than the shutter button lets you focus more precisely in combination with manual focusing.

1. Set [ AF w/ shutter] to [Off].
2. MENU →  2 (Camera Settings2) → [ Custom Key] or [ Custom Key] → assign the [Focus Magnifier] functions to the desired keys.
3. Set [ Eye-Start AF] to [Off] to avoid auto focusing when you look through the viewfinder.
4. Press the AF-ON button to focus.
5. Press the key to which the [Focus Magnifier] function is assigned, and then rotate the focus ring for micro-adjustments of the focus.
6. Press the shutter button fully down to shoot the image.

---

### Related Topic

- [AF On](#)
- [Eye-Start AF \(still image\)](#)
- [Pre-AF \(still image\)](#)
- [Focus Magnifier](#)

Interchangeable Lens Digital Camera  
ILCE-7M3 α7III

## Pre-AF (still image)

---

The product automatically adjusts focus before you press the shutter button halfway down. During focusing operations, the screen may shake.

1 MENU →  1 (Camera Settings1) → [ Pre-AF] → desired setting.

### Menu item details

**On:**

Adjusts focus before you press the shutter button halfway down.

**Off:**

Does not adjust focus before you press the shutter button halfway down.

**Note**



- [ Pre-AF] is available only when an E-mount lens is mounted.

Interchangeable Lens Digital Camera  
ILCE-7M3 α7III

## Eye-Start AF (still image)

---

Sets whether or not to use autofocus when you look through an Electronic Viewfinder.

**1** MENU →  (Camera Settings1) → [ Eye-Start AF] → desired setting.

### Menu item details

**On:**

Auto focusing starts when you look through the Electronic Viewfinder.

**Off:**

Auto focusing does not start when you look through the Electronic Viewfinder.



#### Hint

- [ Eye-Start AF] is available when an A-mount lens and a Mount Adaptor (LA-EA2, LA-EA4) (sold separately) are attached.



## Registering the current focus area (AF Area Regist.) (still image)

You can move the focusing frame to a preassigned position temporarily using a custom key. This function is useful when shooting scenes in which the subject's movements are predictable; for example, sports scenes. With this function, you can switch the focus area quickly according to the situation.

### How to register focus area

1. MENU →  1 (Camera Settings1) → [ AF Area Regist.] → [On].
2. Set the focus area to the desired position and then hold down the Fn (Function) button.



### How to call up the registered focus area

1. MENU →  2 (Camera Settings2) → [ Custom Key] → desired key, then select [Regist. AF Area hold].
2. Set the camera to the shooting mode, hold down the key to which [Regist. AF Area hold] has been assigned and then press the shutter button to shoot images.

#### Hint

- When a focusing frame is registered using [ AF Area Regist.], the registered focusing frame flashes on the monitor.
- If you assign [Regist AF Area toggle] to a custom key, you can use the registered focusing frame without holding down the key.
- If [Reg. AF Area+AF On] is assigned to a custom key, auto focusing using the registered focusing frame is performed when the key is pressed.

#### Note

- A focus area cannot be registered in the following situations:
  - The mode dial is set to either  (Movie) or **S&Q**
  - While [Touch Focus] is being performed
  - While using the digital zoom function
  - While [Lock-on AF] is being performed
  - While focusing
  - While performing focus lock
- You cannot assign [Regist. AF Area hold] to [Left Button], [Right Button], or [Down Button].
- You cannot call up the registered focus area in the following situations:
  - The mode dial is set to either **AUTO** (Auto Mode),  (Movie) or **S&Q**
- When [ AF Area Regist.] is set to [On], the [Lock Operation Parts] setting is locked to [Off].

### Related Topic

- [Focus Area](#)
- [Custom Key \(still image/movie/playback\)](#)

Interchangeable Lens Digital Camera  
ILCE-7M3 α7III

## Deleting a registered AF Area (Del. Reg. AF Area)

---

Deletes the focusing frame position that was registered using [ AF Area Regist.].

**1** MENU →  (Camera Settings1) → [ Del. Reg. AF Area].

---

---

### Related Topic

- [Registering the current focus area \(AF Area Regist.\) \(still image\)](#)

Interchangeable Lens Digital Camera  
ILCE-7M3 α7III

## AF Area Auto Clear

---

Sets whether the focus area should be displayed all the time or should disappear automatically shortly after focus is achieved.

**1** MENU →  1 (Camera Settings1) → [AF Area Auto Clear] → desired setting.

### Menu item details

**On:**

The focus area disappears automatically shortly after focus is achieved.

**Off:**

The focus area is displayed all the time.

Interchangeable Lens Digital Camera  
ILCE-7M3 α7III

## Disp. cont. AF area

You can set whether or not to display the area that is in focus when [Focus Area] is set to [Wide] or [Zone], in [Continuous AF] mode.

1 MENU →  1 (Camera Settings1) → [Disp. cont. AF area] → desired setting.

### Menu item details

#### On:

Displays the focus area that is in focus.

#### Off:

Does not display the focus area that is in focus.

#### Note

- When [Focus Area] is set to one of the following, the focusing frames in the area that is in focus turn green:
  - [Center]
  - [Flexible Spot]
  - [Expand Flexible Spot]
- When an A-mount lens and a Mount Adaptor (LA-EA1/LA-EA3) (sold separately) are mounted on the camera and [  AF System] is set to [Phase Detection AF], [Disp. cont. AF area] is always turned on regardless of the [Focus Area] settings.



Interchangeable Lens Digital Camera  
ILCE-7M3 α7III

## AF Micro Adj.

Allows you to adjust the auto-focusing position and register an adjusted value for each lens when using A-mount lenses with an LA-EA2 or LA-EA4 Mount Adaptor (sold separately).

Use this function only when adjustments are needed. Note that the auto focus function may not be performed at a proper position when using this adjustment.

1 MENU →  1 (Camera Settings1) → [AF Micro Adj.].

2 Select [AF Adjustment Set.] → [On].

3 [amount] → desired value.

- The larger the value you select, the farther the autofocused position will be from the product. The smaller the value you select, the closer the autofocused position will be to the product.

### Hint

- It is recommended that you adjust the position under actual shooting conditions. Set [Focus Area] to [Flexible Spot] and use a bright subject with high contrast when you adjust.

### Note

- When you attach a lens for which you have already registered a value, the registered value appears on the screen. [±0] appears for lenses for which a value has not yet been registered.
- If [-] is displayed as the value, then a total of 30 lenses have been registered and no new lens can be registered. To register a new lens, attach a lens for which the registration can be erased, and set its value to [±0], or reset the values of all the lenses using [Clear].
- The [AF Micro Adj.] supports Sony, Minolta, or Konica-Minolta lenses. If you perform [AF Micro Adj.] with lenses other than the supported lenses, the registered settings for the supported lenses may be affected. Do not perform [AF Micro Adj.] with an unsupported lens.
- You cannot set [AF Micro Adj.] individually for a Sony, Minolta, and Konica-Minolta lens of the same specification.

Interchangeable Lens Digital Camera  
 ILCE-7M3 α7III

## Exposure Comp.

Normally, exposure is set automatically (auto exposure). Based on the exposure value set by auto exposure, you can make the entire image brighter or darker if you adjust [Exposure Comp.] to the plus side or minus side, respectively (exposure compensation).

### 1 Turn the exposure compensation dial (A).

**+ (over) side:**

Images become brighter.

**- (under) side:**

Images become darker.

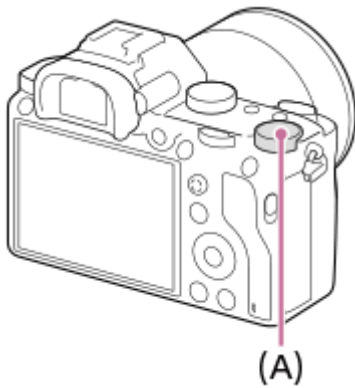

- You can adjust the exposure compensation value within the range of -3.0 EV to +3.0 EV.
- You can confirm the exposure compensation value that you set on the shooting screen.

**Monitor**

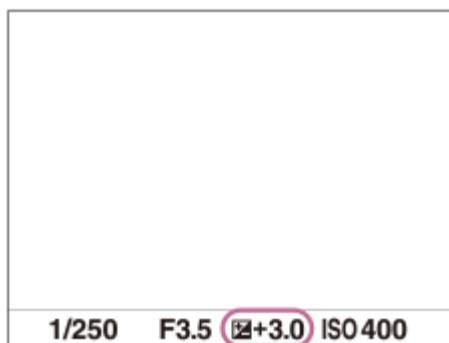

**Viewfinder**



## To set the exposure compensation value using the MENU

You can adjust the exposure compensation value within a range of -5.0 EV to +5.0 EV when the exposure compensation dial is set to "0."

MENU →  1 (Camera Settings1) → [Exposure Comp.] → desired setting.

### Note

- You cannot perform the exposure compensation in the following shooting modes:
  - [Intelligent Auto]
  - [Scene Selection]
- When using [Manual Exposure], you can perform the exposure compensation only when [ISO] is set to [ISO AUTO].
- The settings of the exposure compensation dial will be prioritized over [Exposure Comp.] or [Dial Ev Comp] in MENU.
- Only a value between -3.0 EV and +3.0 EV with the equivalent image brightness appears on the screen when shooting. If you set an exposure compensation value outside this range, the image brightness on the screen will not be affected, but the value will be reflected in the recorded image.
- You can adjust the exposure compensation value within the range of -2.0 EV to +2.0 EV for movies.
- If you shoot a subject in extremely bright or dark conditions, or when you use the flash, you may not be able to get a satisfactory effect.
- When you set the exposure compensation dial to "0" from a setting other than "0," the exposure value switches to "0" regardless of the [Exposure Comp.] setting.

---

### Related Topic

- [Exposure step](#)
- [Dial Ev Comp](#)
- [Exp.comp.set](#)
- [Cont. Bracket](#)
- [Single Bracket](#)
- [Zebra Setting](#)

Interchangeable Lens Digital Camera  
ILCE-7M3 α7III

## Reset EV Comp.

---

Sets whether to maintain the exposure value set using [Exposure Comp.] when you turn off the power when the exposure compensation dial position is set to “0.”

**1** MENU →  1 (Camera Settings1) → [Reset EV Comp.] → desired setting.

### Menu item details

**Maintain:**

Maintains the settings.

**Reset:**

Resets the settings.

Interchangeable Lens Digital Camera  
ILCE-7M3 α7III

## ISO

Sensitivity to light is expressed by the ISO number (recommended exposure index). The larger the number, the higher the sensitivity.

### 1 ISO (ISO) on the control wheel → select desired setting.

- You can also select MENU →  1 (Camera Settings1) → [ISO].
- You can change the value by 1/3 EV steps by turning the front dial as well as by turning the control wheel. You can change the value by 1 EV steps by turning the rear dial.

### Menu item details

#### ISO AUTO:

Sets the ISO sensitivity automatically.

#### ISO 50 – ISO 204800:

Sets the ISO sensitivity manually. Selecting a larger number increases the ISO sensitivity.

#### Hint

- You can change the range of ISO sensitivity that is set automatically in [ISO AUTO] mode. Select [ISO AUTO] and press the right side of the control wheel, and set the desired values for [ISO AUTO Maximum] and [ISO AUTO Minimum].

#### Note

- [ISO AUTO] is selected when using the following functions:
  - [Intelligent Auto]
  - [Scene Selection]
- When the ISO sensitivity is set to a value lower than ISO 100, the range for recordable subject brightness (dynamic range) may decrease.
- The higher the ISO value, the more noise will appear on the images.
- The available ISO settings will differ depending on whether you are shooting still images, shooting movies, or shooting slow-motion/quick-motion movies.
- When shooting movies, ISO values between 100 and 102400 are available. If the ISO value is set to a value larger than 102400, the setting is automatically switched to 102400. When you finish recording the movie, the ISO value returns to the original setting.
- When shooting movies, ISO values between 100 and 102400 are available. If the ISO value is set to a value smaller than 100, the setting is automatically switched to 100. When you finish recording the movie, the ISO value returns to the original setting.
- When you select [ISO AUTO] with the shooting mode set to [P], [A], [S] or [M], the ISO sensitivity will be automatically adjusted within the set range.

Interchangeable Lens Digital Camera  
ILCE-7M3 α7III

## ISO AUTO Min. SS

If you select [ISO AUTO] when the shooting mode is P (Program Auto) or A (Aperture Priority), you can set the shutter speed at which the ISO sensitivity starts changing.

This function is effective for shooting moving subjects. You can minimize subject blurring while also preventing camera shake.

1 MENU →  1 (Camera Settings1) → [ISO AUTO Min. SS] → desired setting.

### Menu item details

#### **FASTER (Faster)/FAST (Fast):**

The ISO sensitivity will start to change at shutter speeds faster than [Standard], so you can prevent camera shake and subject blurring.

#### **STD (Standard):**

The camera automatically sets the shutter speed based on the focal length of the lens.

#### **SLOW (Slow)/SLOWER (Slower):**

The ISO sensitivity will start to change at shutter speeds slower than [Standard], so you can shoot images with less noise.

#### **1/8000 — 30":**

The ISO sensitivity starts to change at the shutter speed you have set.

#### Hint

- The difference in shutter speed at which ISO sensitivity starts to change between [Faster], [Fast], [Standard], [Slow], and [Slower] is 1 EV.

#### Note

- If the exposure is insufficient even when the ISO sensitivity is set to [ISO AUTO Maximum] in [ISO AUTO], in order to shoot with an appropriate exposure, the shutter speed will be slower than the speed set in [ISO AUTO Min. SS].
- In the following situations, the shutter speed may not function as set:
  - When using the flash to shoot bright scenes. (The maximum shutter speed is limited to the flash-syncing speed of 1/250 second.)
  - When using the flash to shoot dark scenes with the [Flash Mode] set to [Fill-flash]. (The minimum shutter speed is limited to the speed automatically determined by the camera.)

### Related Topic

- [Program Auto](#)
- [Aperture Priority](#)
- [ISO](#)

Interchangeable Lens Digital Camera  
ILCE-7M3 α7III

## Metering Mode

Selects the metering mode that sets which part of the screen to measure for determining the exposure.

1 MENU →  (Camera Settings1) → [Metering Mode] → desired setting.

### Menu item details

#### Multi:

Measures light on each area after dividing the total area into multiple areas and determines the proper exposure of the entire screen (Multi-pattern metering).

#### Center:

Measures the average brightness of the entire screen, while emphasizing the central area of the screen (Center-weighted metering).

#### Spot:

Measures only the central area (Spot metering). This mode is suitable for measuring light on a specified part of the entire screen. The size of the metering circle can be selected from [Spot: Standard] and [Spot: Large]. The position of the metering circle depends on the setting for [Spot Metering Point].

#### Entire Screen Avg.:

Measures the average brightness of the entire screen. The exposure will be stable even if the composition or the position of the subject changes.

#### Highlight:

Measures the brightness while emphasizing the highlighted area on the screen. This mode is suitable for shooting the subject while avoiding overexposure.

### Hint

- When [Spot] is selected and [Focus Area] is set to either [Flexible Spot] or [Expand Flexible Spot] while [Spot Metering Point] is set to [Focus Point Link], the spot metering point can be coordinated with the focus area.
- When [Multi] is selected and [Face Prty in Mlti Mtr] is set to [On], the camera measures brightness based on detected faces.
- When [Metering Mode] is set to [Highlight] and the [D-Range Opt.] or [Auto HDR] function is activated, the brightness and the contrast will be corrected automatically by dividing the image into small areas and analyzing the contrast of light and shadow. Make settings based on the shooting circumstances.

### Note

- [Metering Mode] is locked to [Multi] in the following shooting modes:
  - [Intelligent Auto]
  - [Scene Selection]
  - Other zoom functions than the optical zoom
- In [Highlight] mode, the subject may be dark if a brighter part exists on the screen.

### Related Topic

- [AE lock](#)
- [Spot Metering Point](#)
- [Face Prty in Mlti Mtr](#)
- [D-Range Opt. \(DRO\)](#)
- [Auto HDR](#)





Interchangeable Lens Digital Camera  
ILCE-7M3 α7III

## Face Prty in Mlti Mtr

---

Sets whether the camera measures brightness based on detected faces when [Metering Mode] is set to [Multi].

1 MENU →  1 (Camera Settings1) → [Face Prty in Mlti Mtr] → desired setting.

### Menu item details

#### On:

The camera measures brightness based on detected faces.

#### Off:

The camera measures brightness using the [Multi] setting, without detecting faces.

#### Note

- When the shooting mode is set to [Intelligent Auto], [Face Prty in Mlti Mtr] is locked to [On].

---

### Related Topic

- [Metering Mode](#)

Interchangeable Lens Digital Camera  
ILCE-7M3 α7III

## Spot Metering Point

---

Sets whether to coordinate the spot metering position with the focus area when [Focus Area] is set to [Flexible Spot] or [Expand Flexible Spot].

1 MENU →  1 (Camera Settings1) → [Spot Metering Point] → desired setting.

### Menu item details

#### Center:

The spot metering position does not coordinate with the focus area, but always meters brightness at the center.

#### Focus Point Link:

The spot metering position coordinates with the focus area.

#### Note

- When [Focus Area] is set to other than [Flexible Spot] or [Expand Flexible Spot], the spot metering position is locked to the center.
- When [Focus Area] is set to [Lock-on AF: Flexible Spot] or [Lock-on AF:Expand Flexible Spot], the spot metering position coordinates to the Lock-on AF start position, but does not coordinate with the tracking of the subject.

---

### Related Topic

- [Focus Area](#)
- [Metering Mode](#)

Interchangeable Lens Digital Camera  
ILCE-7M3 α7III

## Exposure step

---

You can adjust the setting increment for the shutter speed, aperture, and exposure compensation values.

**1** MENU →  (Camera Settings1) → [Exposure step] → desired setting.

### Menu item details

**0.3EV/0.5EV**

**Note**



- Even if you set [Exposure step] to [0.5EV], the exposure value adjusted using the exposure compensation dial changes in steps of 0.3EV.

Interchangeable Lens Digital Camera  
ILCE-7M3 α7III

## AEL w/ shutter (still image)

---

Sets whether to fix the exposure when you press the shutter button halfway down.  
Select [Off] to adjust the focus and the exposure separately.

1 MENU →  (Camera Settings1) → [ AEL w/ shutter] → desired setting.

### Menu item details

#### Auto:

Fixes the exposure after adjusting the focus automatically when you press the shutter button halfway down when [Focus Mode] is set to [Single-shot AF]. When [Focus Mode] is set to [Automatic AF], and the product determines that the subject is moving, or you shoot burst images, the fixed exposure is cancelled.

#### On:

Fixes the exposure when you press the shutter button halfway down.

#### Off:

Does not fix the exposure when you press the shutter button halfway down. Use this mode when you want to adjust focus and exposure separately.

The product keeps adjusting the exposure while shooting in [Cont. Shooting] mode.

#### Note

- Operation using the AEL button is prioritized over the [ AEL w/ shutter] settings.

Interchangeable Lens Digital Camera  
ILCE-7M3 α7III

## Exposure Std. Adjust

Adjusts this camera's standard for the correct exposure value for each metering mode.

- 1 MENU →  1 (Camera Settings1) → [Exposure Std. Adjust] → desired metering mode.
- 2 Select the desired value as the metering standard.
  - You can set a value from -1 EV to +1 EV in 1/6 EV increments.

## Metering Mode

The set standard value will be applied when you select the corresponding metering mode in MENU →  1 (Camera Settings1) → [Metering Mode].

 Multi/  Center/  Spot/  Entire Screen Avg./  Highlight

### Note

- The exposure compensation will not be affected when [Exposure Std. Adjust] is changed.
- The exposure value will be locked according to the value set for [  Spot] during using spot AEL.
- The standard value for M.M (Metered Manual) will be changed according to the value set in [Exposure Std. Adjust].
- The value set in [Exposure Std. Adjust] is recorded in Exif data separately from the exposure compensation value. The amount of exposure standard value will not be added to the exposure compensation value.
- If you set [Exposure Std. Adjust] during bracketing shooting, the number of shots for the bracketing will be reset.

## Related Topic

- [Metering Mode](#)

Interchangeable Lens Digital Camera  
ILCE-7M3 α7III

## Flash Mode

---

You can set the flash mode.

1 MENU →  1 (Camera Settings1) → [Flash Mode] → desired setting.

### Menu item details

#### Flash Off:

The flash does not operate.

#### Autoflash:

The flash works in dark environments or when shooting towards bright light.

#### Fill-flash:

The flash works every time you trigger the shutter.

#### Slow Sync.:

The flash works every time you trigger the shutter. Slow sync shooting allows you to shoot a clear image of both the subject and the background by slowing the shutter speed.

#### Rear Sync.:

The flash works right before the exposure is completed every time you trigger the shutter. Rear sync shooting allows you to shoot a natural image of the trail of a moving subject such as a moving car or a walking person.

#### Note

- The default setting depends on the shooting mode.
- Some [Flash Mode] settings are not available, depending on the shooting mode.

---

### Related Topic

- [Using flash \(sold separately\)](#)
- [Wireless Flash](#)

Interchangeable Lens Digital Camera  
ILCE-7M3 α7III

## Flash Comp.

Adjusts the amount of flash light in a range of  $-3.0$  EV to  $+3.0$  EV. Flash compensation changes the amount of flash light only. Exposure compensation changes the amount of flash light along with the change of the shutter speed and aperture.

1 MENU →  1 (Camera Settings1) → [Flash Comp.] → desired setting.

- Selecting higher values (+ side) makes the flash level higher, and lower values (- side) makes the flash level lower.

### Note

- [Flash Comp.] does not work when the shooting mode is set to the following modes:
  - [Intelligent Auto]
  - [Scene Selection]
- The higher flash effect (+ side) may not be visible due to the limited amount of flash light available, if the subject is outside the maximum range of the flash. If the subject is very close, the lower flash effect (- side) may not be visible.
- If you attach an ND filter to the lens or attach a diffuser or a color filter to the flash, the appropriate exposure may not be achieved and images may turn out dark. In this case, adjust [Flash Comp.] to the desired value.

### Related Topic

- [Using flash \(sold separately\)](#)

Interchangeable Lens Digital Camera  
ILCE-7M3 α7III

## Exp.comp.set

---

Sets whether to apply the exposure compensation value to control both flash light and ambient light, or just ambient light.

**1** MENU →  (Camera Settings1) → [Exp.comp.set] → desired setting.

### Menu item details

**Ambient&flash:**

Applies the exposure compensation value to control both flash light and ambient light.

**Ambient only:**

Applies the exposure compensation value to control ambient light only.

---

### Related Topic

- [Flash Comp.](#)



Interchangeable Lens Digital Camera  
ILCE-7M3 α7III

## Wireless Flash

There are two methods for wireless flash shooting: light-signal flash shooting that uses the light of the flash attached to the camera as a signal light, and radio-signal flash shooting that uses wireless communication. To perform radio-signal flash shooting, use a compatible flash or the Wireless Radio Commander (sold separately). For details on how to set each method, refer to the instruction manual of the flash or the Wireless Radio Commander.

- 1 Remove the shoe cap from the camera, and then attach the flash or the Wireless Radio Commander.**
  - When performing wireless flash shooting with a flash attached, set the attached flash as the controller.
- 2 MENU →  1 (Camera Settings1) → [Wireless Flash] → [On].**
- 3 Set up an off-camera flash that is set to wireless mode, or that is attached to the Wireless Radio Receiver (sold separately).**
  - Press the AEL button on the camera to perform a test flashing.

### Menu item details



#### Off:

Does not use the wireless flash function.

#### On:

Uses the wireless flash function to make an external flash or flashes emit light at a distance from the camera.

### Setting of the AEL button

We recommend that you set MENU →  2 (Camera Settings2) → [ Custom Key] → [AEL Button] to [AEL hold] when performing wireless flash shooting.

#### Note

- The off-camera flash may emit light after receiving a light signal from a flash used as the controller of another camera. If this occurs, change the channel of your flash. For details on how to change the channel, refer to the instruction manual for the flash.
- For the flash that is compatible with wireless flash shooting, visit the Sony website, or consult your Sony dealer or local authorized Sony service facility.

Interchangeable Lens Digital Camera  
ILCE-7M3 α7III

## Red Eye Reduction

---

When using the flash, it is fired two or more times before shooting to reduce the red-eye phenomenon.

**1** MENU →  1 (Camera Settings1) → [Red Eye Reduction] → desired setting.

### Menu item details

**On:**

The flash is always fired to reduce the red-eye phenomenon.

**Off:**

Does not use Red Eye Reduction.

**Note**

- Red Eye Reduction may not produce the desired effects. It depends on individual differences and conditions, such as distance to the subject, or whether the subject looks at the pre-strobe or not.













Interchangeable Lens Digital Camera  
ILCE-7M3 α7III

## White Balance

Corrects the tone effect of the ambient light condition to record a neutral white subject in white. Use this function when the color tones of the image did not come out as you expected, or when you want to change the color tones on purpose for photographic expression.

1 MENU →  1 (Camera Settings1) → [White Balance] → desired setting.

### Menu item details

   Auto/  Daylight/  Shade/  Cloudy/  Incandescent/  -1 Fluor.: Warm White/  0 Fluor.: Cool White/  +1 Fluor.: Day White/  +2 Fluor.: Daylight/  Flash/  Underwater Auto: When you select a light source that illuminates the subject, the product adjusts the color tones to suit to the selected light source (preset white balance). When you select [Auto], the product automatically detects the light source and adjusts the color tones.

 **C.Temp./Filter:**

Adjusts the color tones depending on the light source. Achieves the effect of CC (Color Compensation) filters for photography.

 **Custom 1/Custom 2/Custom 3:**



Uses the white balance setting saved in [Custom Setup].

 **SET Custom Setup:**

Memorizes the basic white color under the light conditions for the shooting environment.

Select a memorized custom white balance number.

### Hint

- You can display the fine adjustment screen and perform fine adjustments of the color tones as required by pressing the right side of the control wheel.
- If the color tones do not come out as you expected in the selected settings, perform [WB bracket] shooting.
-  or  is displayed only when [Priority Set in AWB] is set to [Ambience] or [White].

### Note

- [White Balance] is fixed to [Auto] in the following shooting modes:
  - [Intelligent Auto]
  - [Scene Selection]
- If you use a mercury lamp or a sodium lamp as a light source, the accurate white balance will not be obtained because of the characteristics of the light. It is recommended to shoot images using a flash or select [Custom Setup].

### Related Topic

- [Capturing a basic white color in \[Custom Setup\] mode](#)
- [Priority Set in AWB](#)
- [WB bracket](#)

Interchangeable Lens Digital Camera  
ILCE-7M3 α7III

## Priority Set in AWB

---

Selects which tone to prioritize when shooting under lighting conditions such as incandescent light when [White Balance] is set to [Auto].

1 MENU →  1 (Camera Settings1) → [Priority Set in AWB] → desired setting.

### Menu item details

AWB  
STD **Standard:**

Shoots with standard auto white balance. The camera automatically adjusts the color tones.

AWB  
Ambi **Ambience:**

Prioritizes the color tone of the light source. This is suitable when you want to produce a warm atmosphere.

AWB  
White **White:**

Prioritizes a reproduction of white color when the color temperature of the light source is low.

---

### Related Topic

- [White Balance](#)

Interchangeable Lens Digital Camera  
ILCE-7M3 α7III

## D-Range Opt. (DRO)

By dividing the image into small areas, the product analyzes the contrast of light and shadow between the subject and the background, and creates an image with the optimal brightness and gradation.

- 1 MENU →  1 (Camera Settings1) → [DRO/Auto HDR] → [D-Range Opt.].
- 2 Select the desired setting using the left/right sides of the control wheel.

### Menu item details

#### D-Range Optimizer: Auto:

Corrects the brightness automatically.

#### D-Range Optimizer: Lv1 — D-Range Optimizer: Lv5:

Optimizes the gradation of a recorded image for each divided area. Select the optimization level from Lv1 (weak) to Lv5 (strong).

#### Note

- In the following situations, [D-Range Opt.] is fixed to [Off]:
  - When [Picture Effect] is set to other than [Off]
  - When [Picture Profile] is set to other than [Off]
- [DRO/Auto HDR] is fixed to [Off] when the following modes are selected in [Scene Selection].
  - [Sunset]
  - [Night Scene]
  - [Night Portrait]

The setting is fixed to [D-Range Optimizer: Auto] when [Scene Selection] modes other than the above modes are selected.

- When shooting with [D-Range Opt.], the image may be noisy. Select the proper level by checking the recorded image, especially when you enhance the effect.

Interchangeable Lens Digital Camera  
ILCE-7M3 α7III

## Auto HDR

Shoots three images using different exposures and combines the images with correct exposure, the bright parts of an underexposed image, and the dark parts of an overexposed image to create images with a greater range of gradation (High Dynamic Range). One image with proper exposure and one overlaid image are recorded.

1 MENU →  1 (Camera Settings1) → [DRO/Auto HDR] → [Auto HDR].

2 Select the desired setting using the left/right sides of the control wheel.

### Menu item details

 **Auto HDR: Exposure Diff. Auto:**

Corrects the brightness automatically.

 **Auto HDR: Exposure Diff. 1.0EV — Auto HDR: Exposure Diff. 6.0EV:**



Sets the exposure difference, based on the contrast of the subject. Select the optimization level from 1.0EV (weak) to 6.0EV (strong).

For example, if you set the exposure value to 2.0 EV, three images will be composed with the following exposure levels: -1.0 EV, correct exposure and +1.0 EV.

#### Hint

- The shutter is released three times for one shot. Be careful about the following:
  - Use this function when the subject is motionless or does not flash light.
  - Do not change the composition before shooting.

#### Note

- This function is not available when the [ File Format] is [RAW] or [RAW & JPEG].
- [Auto HDR] is not available in the following shooting modes:
  - [Intelligent Auto]
  - [Scene Selection]
- [Auto HDR] is not available in the following situations:
  - When [Picture Effect] is set to other than [Off].
  - When [Picture Profile] is set to other than [Off].
- You cannot start the next shot until the capture process is completed after you shoot.
- You may not obtain the desired effect depending on the luminance difference of a subject and the shooting conditions.
- When the flash is used, this function has little effect.
- When the contrast of the scene is low or when product shake or subject blur occurs, you may not obtain good HDR images.   will be displayed over the recorded image to inform you when the camera detects image blurring. Change the composition or re-shoot the image carefully to avoid image blur, as needed.

Interchangeable Lens Digital Camera  
ILCE-7M3 α7III

## Creative Style

Allows you to set the desired image processing and finely adjust contrast, saturation and sharpness for each image style. You can adjust exposure (shutter speed and aperture) as you like with this function, unlike with [Scene Selection], where the product adjusts the exposure.

- 1 MENU → 1 (Camera Settings1) → [Creative Style].
- 2 Select the desired style or [Style Box] using the top/bottom sides of the control wheel.
- 3 To adjust (Contrast), (Saturation) and (Sharpness), select the desired item using the right/left sides, and then select the value using the top/bottom sides.

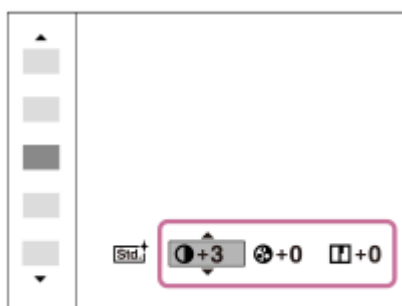

- 4 When selecting [Style Box], move to the right side using the right side of the control wheel, and then select the desired style.

- You can call up the same style with slightly different settings.

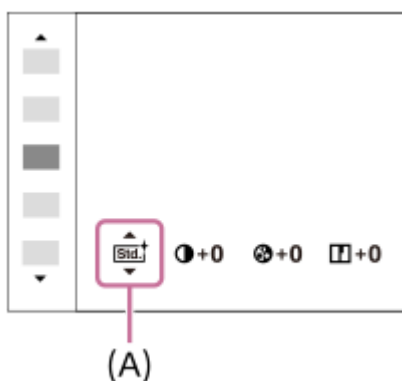

(A): Displayed only when Style Box is selected

### Menu item details

#### Standard:

For shooting various scenes with rich gradation and beautiful colors.

#### Vivid:

The saturation and contrast are heightened for shooting striking images of colorful scenes and subjects such as flowers, spring greenery, blue sky, or ocean views.

#### Neutral:

The saturation and sharpness are lowered for shooting images in subdued tones. This is also suitable for capturing image material to be modified with a computer.

 **Clear:**

For shooting images in clear tones with limpid colors in highlight, suitable for capturing radiant light.

 **Deep:**

For shooting images with deep and dense colors, suitable for capturing the solid presence of the subject.

 **Light:**

For shooting images with bright and simple colors, suitable for capturing a refreshingly light ambience.

 **Portrait:**

For capturing skin in a soft tone, ideally suited for shooting portraits.

 **Landscape:**

The saturation, contrast, and sharpness are heightened for shooting vivid and crisp scenery. Distant landscapes also stand out more.

 **Sunset:**

For shooting the beautiful red of the setting sun.

 **Night Scene:**

The contrast is lowered for reproducing night scenes.

 **Autumn leaves:**

For shooting autumn scenes, vividly highlighting the reds and yellows of changing leaves.

 **Black & White:**

For shooting images in black and white monotone.

 **Sepia:**

For shooting images in sepia monotone.

 **Registering preferred settings (Style Box):**

Select the six style box (the boxes with numbers on the left side (  )) to register preferred settings. Then select the desired settings using the right button.

You can call up the same style with slightly different settings.

## To set [Contrast], [Saturation] and [Sharpness]

[Contrast], [Saturation], and [Sharpness] can be adjusted for each image style preset such as [Standard] and [Landscape], and for each [Style Box] to which you can register preferred settings.

Select an item to be set by pressing the right/left sides of the control wheel, then set the value using the top/bottom sides of the control wheel.

 **Contrast:**

The higher the value selected, the more the difference of light and shadow is accentuated, and the bigger the effect on the image.

 **Saturation:**

The higher the value selected, the more vivid the color. When a lower value is selected, the color of the image is restrained and subdued.

 **Sharpness:**

Adjusts the sharpness. The higher the value selected, the more the contours are accentuated, and the lower the value selected, the more the contours are softened.

### Note

- [Creative Style] is fixed to [Standard] in the following situations:
  - [Intelligent Auto]
  - [Scene Selection]
  - [Picture Effect] is set to other than [Off].
  - [Picture Profile] is set to other than [Off].
- When this function is set to [Black & White] or [Sepia], [Saturation] cannot be adjusted.



Interchangeable Lens Digital Camera  
ILCE-7M3 α7III

## Picture Effect

Select the desired effect filter to achieve more impressive and artistic images.

1 MENU →  (Camera Settings1) → [Picture Effect] → desired setting.

### Menu item details

 **Off:**

Disables the [Picture Effect] function.

 **Toy Camera:**

Creates a soft image with shaded corners and reduced sharpness.

 **Pop Color:**

Creates a vivid look by emphasizing color tones.

 **Posterization:**

Creates a high contrast, abstract look by heavily emphasizing primary colors, or in black and white.

 **Retro Photo:**

Creates the look of an aged photo with sepia color tones and faded contrast.

 **Soft High-key:**

Creates an image with the indicated atmosphere: bright, transparent, ethereal, tender, soft.

 **Partial Color:**

Creates an image which retains a specific color, but converts others to black and white.

 **High Contrast Mono.:**

Creates a high-contrast image in black and white.

 **Rich-tone Mono.:**

Creates an image in black and white with rich gradation and reproduction of details.

### Hint

- You can perform detailed settings for some items using the left/right sides of the control wheel.

### Note

- When you use a zoom function other than the optical zoom, setting the zoom scale larger makes [Toy Camera] less effective.
- When [Partial Color] is selected, images may not retain the selected color, depending on the subject or shooting conditions.
- You cannot check the following effects on the shooting screen, because the product processes the image after the shot. Also, you cannot shoot another image until image processing is finished. You cannot use these effects with movies.
  - [Rich-tone Mono.]
- In the case of [Rich-tone Mono.], the shutter is released three times for one shot. Be careful about the following:
  - Use this function when the subject is motionless or does not flash light.
  - Do not change the composition during shooting.

When the contrast of the scene is low or when significant camera-shake or subject blur has occurred, you may not be able to obtain good HDR images. If the product detects such a situation,  appear on the recorded image to inform you of this situation. Change the composition or re-shoot the image carefully to avoid image blur, as needed.

- This function is not available in the following shooting modes:
  - [Intelligent Auto]
  - [Scene Selection]
- When [ File Format] is set to [RAW] or [RAW & JPEG], this function is not available.



Interchangeable Lens Digital Camera  
ILCE-7M3 α7III

## Picture Profile

Allows you to change the settings for the color, gradation, etc. For details on "Picture Profile," refer to <http://helpguide.sony.net/di/pp/v1/en/index.html>.

### Customizing the picture profile

You can customize the picture quality by adjusting picture profile items such as [Gamma] and [Detail]. When setting these parameters, connect the camera to a TV or monitor, and adjust them while observing the picture on the screen.

- 1 **MENU** →  **1 (Camera Settings1)** → **[Picture Profile]** → **the profile you want to change.**
- 2 **Move to the item index screen by pressing the right side of the control wheel.**
- 3 **Select the item to change using the top/bottom sides of the control wheel.**
- 4 **Select the desired value using the top/bottom sides of the control wheel and press in the center.**

### Using the preset of the picture profile

The default settings [PP1] through [PP10] for movies have been set in advance in the camera based on various shooting conditions.

MENU →  **1 (Camera Settings1)** → **[Picture Profile]** → **desired setting.**

#### PP1:

Example setting using [Movie] gamma.

#### PP2:

Example setting using [Still] gamma.

#### PP3:

Example setting of natural color tone using the [ITU709] gamma.

#### PP4:

Example setting of a color tone faithful to the ITU709 standard.

#### PP5:

Example setting using [Cine1] gamma.

#### PP6:

Example setting using [Cine2] gamma.

#### PP7:

Example setting using [S-Log2] gamma.

#### PP8:

Example setting using the [S-Log3] gamma and the [S-Gamut3.Cine] under [Color Mode].

#### PP9:

Example setting using the [S-Log3] gamma and the [S-Gamut3] under [Color Mode].

#### PP10:

Example setting for recording HDR movies using [HLG2] gamma.

### HDR movie recording

The camera can record HDR movies when a gamma from [HLG], [HLG1] to [HLG3] is selected in the picture profile. Picture profile preset [PP10] provides an example setting for HDR recording. Movies recorded using [PP10] can be viewed with a wider range of brightness than usual when played back on a TV supporting Hybrid Log-Gamma (HLG).

This way, even scenes with a wide range of brightness can be recorded and displayed faithfully, without looking under or over-exposed. HLG is used in HDR TV program production, as defined in the international standard Recommendation ITU-R BT.2100.

## Items of the picture profile

### Black Level

Sets the black level. (-15 to +15)

### Gamma

Selects a gamma curve.

Movie: Standard gamma curve for movies

Still: Standard gamma curve for still images

Cine1: Softens the contrast in dark parts and emphasizes gradation in bright parts to produce a relaxed color movie. (equivalent to HG4609G33)

Cine2: Similar to [Cine1] but optimized for editing with up to 100% video signal. (equivalent to HG4600G30)

Cine3: Intensifies the contrast in light and shade more than [Cine1] and strengthens gradation in black.

Cine4: Strengthens the contrast in dark parts more than [Cine3].

ITU709: Gamma curve that corresponds to ITU709.

ITU709(800%): Gamma curve for confirming scenes on the assumption of shooting using [S-Log2] or [S-Log3].

S-Log2: Gamma curve for [S-Log2]. This setting is based on the assumption that the picture will be processed after shooting.

S-Log3: Gamma curve for [S-Log3] with more similar features to film. This setting is based on the assumption that the picture will be processed after shooting.

HLG: Gamma curve for HDR recording. Equivalent to the HDR standard Hybrid Log-Gamma, ITU-R BT.2100.

HLG1: Gamma curve for HDR recording. Emphasizes noise reduction. However, shooting is restricted to a narrower dynamic range than with [HLG2] or [HLG3].

HLG2: Gamma curve for HDR recording. Provides a balance of dynamic range and noise reduction.

HLG3: Gamma curve for HDR recording. Wider dynamic range than [HLG2]. However, noise may increase.

- [HLG1], [HLG2], and [HLG3] all apply a gamma curve with the same characteristics, but each offers a different balance between dynamic range and noise reduction. Each has a different maximum video output level, as follows: [HLG1]: approx. 87%, [HLG2]: approx. 95%, [HLG3]: approx. 100%.

### Black Gamma

Corrects gamma in low intensity areas.

[Black Gamma] is fixed at "0" and cannot be adjusted when [Gamma] is set to [HLG], [HLG1], [HLG2], or [HLG3].

Range: Selects the correcting range. (Wide / Middle / Narrow)

Level: Sets the correcting level. (-7 (maximum black compression) to +7 (maximum black stretch))

### Knee

Sets knee point and slope for video signal compression to prevent over-exposure by limiting signals in high intensity areas of the subject to the dynamic range of your camera.

[Knee] is disabled if [Mode] is set to [Auto] when [Gamma] is set to [Still], [Cine1], [Cine2], [Cine3], [Cine4], [ITU709(800%)], [S-Log2], [S-Log3], [HLG], [HLG1], [HLG2], or [HLG3]. To enable [Knee], set [Mode] to [Manual].

Mode: Selects auto/manual settings.

- Auto: The knee point and slope are set automatically.
- Manual: The knee point and slope are set manually.

Auto Set: Settings when [Auto] is selected for [Mode].

- Max Point: Sets the maximum point of the knee point. (90% to 100%)
- Sensitivity: Sets the sensitivity. (High / Mid / Low)

Manual Set: Settings when [Manual] is selected for [Mode].

- Point: Sets the knee point. (75% to 105%)

- Slope: Sets the knee slope. (-5 (gentle) to +5 (steep))

### Color Mode

Sets type and level of colors.

In [Color Mode], only [BT.2020] and [709] are available when [Gamma] is set to [HLG], [HLG1], [HLG2], or [HLG3].

Movie: Suitable colors when [Gamma] is set to [Movie].

Still: Suitable colors when [Gamma] is set to [Still].

Cinema: Suitable colors when [Gamma] is set to [Cine1] or [Cine2].

Pro: Similar color tones to the standard image quality of Sony professional cameras (when combined with ITU709 gamma)

ITU709 Matrix: Colors corresponding to ITU709 standard (when combined with ITU709 gamma)

Black & White: Sets the saturation to zero for shooting in black and white.

S-Gamut: Setting based on the assumption that the pictures will be processed after shooting. Used when [Gamma] is set to [S-Log2].

S-Gamut3.Cine: Setting based on the assumption that the pictures will be processed after shooting. Used when [Gamma] is set to [S-Log3]. This setting allows you to shoot in a color space that can easily be converted for digital cinema.

S-Gamut3: Setting based on the assumption that the pictures will be processed after shooting. Used when [Gamma] is set to [S-Log3]. This setting allows you to shoot in a wide color space.

BT.2020: Standard color tone when [Gamma] is set to [HLG], [HLG1], [HLG2], or [HLG3].

709: Color tone when [Gamma] is set to [HLG], [HLG1], [HLG2], or [HLG3] and movies are recorded with HDTV color (BT.709).

### Saturation

Sets the color saturation. (-32 to +32)

### Color Phase

Sets the color phase. (-7 to +7)

### Color Depth

Sets the color depth for each color phase. This function is more effective for chromatic colors and less effective for achromatic colors. The color looks deeper as you increase the setting value towards the positive side, and lighter as you decrease the value towards the negative side. This function is effective even if you set [Color Mode] to [Black & White].

[R] -7 (light red) to +7 (deep red)

[G] -7 (light green) to +7 (deep green)

[B] -7 (light blue) to +7 (deep blue)

[C] -7 (light cyan) to +7 (deep cyan)

[M] -7 (light magenta) to +7 (deep magenta)

[Y] -7 (light yellow) to +7 (deep yellow)

### Detail

Sets items for [Detail].

Level: Sets the [Detail] level. (-7 to +7)

Adjust: The following parameters can be selected manually.

- Mode: Selects auto/manual setting. (Auto (automatic optimization) / Manual (The details are set manually.))
- V/H Balance: Sets the vertical (V) and horizontal (H) balance of DETAIL. (-2 (off to the vertical (V) side) to +2 (off to the horizontal (H) side))
- B/W Balance: Selects the balance of the lower DETAIL (B) and the upper DETAIL (W). (Type1 (off to the lower DETAIL (B) side) to Type5 (off to the upper DETAIL (W) side))
- Limit: Sets the limit level of [Detail]. (0 (Low limit level: likely to be limited) to 7 (High limit level: unlikely to be limited))
- Crisping: Sets the crisping level. (0 (shallow crisping level) to 7 (deep crisping level))
- Hi-Light Detail: Sets the [Detail] level in the high intensity areas. (0 to 4)

### To copy the settings to another picture profile number

You can copy the settings of the picture profile to another picture profile number.

MENU →  1 (Camera Settings1) → [Picture Profile] → [Copy].

### To Reset the picture profile to the default setting

You can reset the picture profile to the default setting. You cannot reset all picture profile settings at once.

MENU →  1 (Camera Settings1) → [Picture Profile] → [Reset].

#### Note

- Since the parameters are shared for movie and still images, adjust the value when you change the shooting mode.
- If you develop RAW images with shooting settings, the following settings are not reflected:
  - Black Level
  - Black Gamma
  - Knee
  - Color Depth
- If you change [Gamma], the available ISO value range changes.
- There may be more noise in dark parts depending on the gamma settings. It may improve by setting the lens compensation to [Off].
- When using S-Log2 or S-Log3 gamma, the noise becomes more noticeable compared to when using other gammas. If the noise still is significant even after processing pictures, it may be improved by shooting with a brighter setting. However, the dynamic range becomes narrower accordingly when you shoot with a brighter setting. We recommend checking the picture in advance by test shooting when using S-Log2 or S-Log3.
- Setting [ITU709(800%)], [S-Log2] or [S-Log3] may cause an error in the white balance custom setup. In this case, perform custom setup with a gamma other than [ITU709(800%)], [S-Log2], or [S-Log3] first, and then reselect [ITU709(800%)], [S-Log2], or [S-Log3] gamma.
- Setting [ITU709(800%)], [S-Log2] or [S-Log3] disables the [Black Level] setting.
- If you set [Slope] to +5 in [Manual Set] under [Knee], [Knee] is set to [Off].
- S-Gamut, S-Gamut3.Cine, and S-Gamut3 are color spaces exclusive to Sony. However, this camera's S-Gamut setting does not support the whole S-Gamut color space; it is a setting to achieve a color reproduction equivalent to S-Gamut.

---

#### Related Topic









- [Gamma Disp. Assist](#)

Interchangeable Lens Digital Camera  
ILCE-7M3 α7III

## Focus Magnifier

You can check the focus by enlarging the image before shooting.

Unlike with [ MF Assist], you can magnify the image without operating the focus ring.

- 1 MENU →  (Camera Settings1) → [Focus Magnifier].
- 2 Press the center of the multi-selector to enlarge the image and select the area you want to enlarge by pressing the multi-selector up/down/left/right.
  - Each time you press the center, the magnification scale will change.
  - You can set the initial magnification by selecting MENU →  (Camera Settings1) → [ Initial Focus Mag.].
- 3 Confirm the focus.
  - Press the  (Delete) button to bring the magnified position into the center of an image.
  - When the focus mode is [Manual Focus], you can adjust the focus while an image is magnified. If [ AF in Focus Mag.] is set to [Off], the [Focus Magnifier] function is canceled when the shutter button is pressed halfway down.
  - When the shutter button is pressed halfway down while an image is magnified during the auto-focusing, different functions are performed depending on the [ AF in Focus Mag.] setting.
    - When [ AF in Focus Mag.] is set to [On]: Auto-focusing is performed again.
    - When [ AF in Focus Mag.] is set to [Off]: The [Focus Magnifier] function is canceled.
  - You can set how long the image is to be shown magnified by selecting MENU →  (Camera Settings1) → [Focus Magnif. Time].
- 4 Press the shutter button fully down to shoot the image.

### To use the focus magnifier function by touch operation

You can magnify the image and adjust the focus by touching the monitor. Set [Touch Operation] to [On] beforehand.

Then, select the appropriate settings under [Touch Panel/Pad]. When the focus mode is [Manual Focus], you can perform [Focus Magnifier] by double-tapping the area to focus on while shooting with the monitor.

While shooting with the viewfinder, a frame is displayed in the center of the monitor by double-tapping and you can move the frame by dragging it. The image is magnified by pressing the center of the control wheel.

#### Hint

- While using the focus magnifier function, you can move the magnified area by dragging it on the touch panel.
- To exit the focus magnifier function, double-tap the monitor again. When [ AF in Focus Mag.] is set to [Off], the focus magnifier function is ended by pressing the shutter button halfway down.

#### Related Topic

- [MF Assist \(still image\)](#)
- [Focus Magnif. Time](#)
- [Initial Focus Mag. \(still image\)](#)

- AF in Focus Mag. (still image)
- Custom Key (still image/movie/playback)
- Touch Operation

4-732-947-11(1) Copyright 2018 Sony Corporation



Interchangeable Lens Digital Camera  
ILCE-7M3 α7III

## Focus Magnif. Time

---

Set the duration for which an image is to be magnified using the [ MF Assist] or [Focus Magnifier] function.

**1** MENU →  (Camera Settings1) → [Focus Magnif. Time] → desired setting.

### Menu item details

**2 Sec:**

Magnifies the images for 2 seconds.

**5 Sec:**

Magnifies the images for 5 seconds.

**No Limit:**

Magnifies the images until you press the shutter button.

---

### Related Topic



- [Focus Magnifier](#)
- [MF Assist \(still image\)](#)

Interchangeable Lens Digital Camera  
ILCE-7M3 α7III

## Initial Focus Mag. (still image)

---

Sets the initial magnification scale when using [Focus Magnifier]. Select a setting that will help you frame your shot.

1 MENU →  1 (Camera Settings1) → [ Initial Focus Mag.] → desired setting.

### Menu item details

#### Full-frame shooting

**x1.0:**

Displays the image with the same magnification as the shooting screen.

**x5.9:**

Displays a 5.9-times enlarged image.

#### APS-C/Super 35mm size shooting

**x1.0:**

Displays the image with the same magnification as the shooting screen.

**x3.8:**

Displays a 3.8-times enlarged image.

---





### Related Topic

- [Focus Magnifier](#)

Interchangeable Lens Digital Camera  
ILCE-7M3 α7III

## AF in Focus Mag. (still image)



You can focus on the subject more accurately using auto-focus by magnifying the area where you want to focus. While the magnified image is displayed, you can focus on a smaller area than the flexible spot.

- 1 MENU →  1 (Camera Settings1) → [ AF in Focus Mag.] → [On].
- 2 MENU →  1 (Camera Settings1) → [Focus Magnifier].
- 3 **Magnify the image by pressing the center of the multi-selector, and then adjust the position by pressing the multi-selector up/down/left/right.**
  - The magnification scale changes each time you press the center.
- 4 **Press the shutter button halfway down to focus.**
  - The focus will be achieved at point of  in the center of the screen.
- 5 **Press the shutter button all the way down to shoot.**
  - The camera exits the magnified display after shooting.

### Hint

- Use of a tripod is recommended to accurately identify the location you want to magnify.
- You can check the auto-focusing result by magnifying the displayed image. If you want to readjust the focus position, adjust the focus area on the magnified screen and then press the shutter button halfway down.

### Note

- If you enlarge an area at the edge of the screen, the camera may not be able to focus.
- The exposure and white balance cannot be adjusted while the displayed image is being magnified.
- [ AF in Focus Mag.] is unavailable in the following situations:
  - During movie shooting
  - When [Focus Mode] is set to [Continuous AF].
  - When [Focus Mode] is set to [Automatic AF] and the shooting mode is set to other than P/A/S/M.
  - When [Focus Mode] is set to [Automatic AF] and [Drive Mode] is set to [Cont. Shooting].
  - When using a Mount Adaptor (sold separately).
- While the displayed image is being magnified, the following functions are unavailable:
  - [Eye AF]
  - [Center Lock-on AF]
  - [ Eye-Start AF]
  - [ Pre-AF]
  - [Face Priority in AF]

---

---

## Related Topic

- [Focus Magnifier](#)
- [Custom Key \(still image/movie/playback\)](#)

4-732-947-11(1) Copyright 2018 Sony Corporation

Interchangeable Lens Digital Camera  
ILCE-7M3 α7III

## MF Assist (still image)

Enlarges the image on the screen automatically to make manual focusing easier. This works in Manual Focus or Direct Manual Focus shooting.

1 MENU →  1 (Camera Settings1) → [ MF Assist] → [On].



2 Turn the focus ring to adjust the focus.

- The image is enlarged. You can magnify images further by pressing the center of the control wheel.

### Hint

- You can set how long the image is to be shown magnified by selecting MENU →  1 (Camera Settings1) → [Focus Magnif. Time].

### Note

- You cannot use [ MF Assist] when shooting movies. Use the [Focus Magnifier] function instead.
- [ MF Assist] is not available when a Mount Adaptor is attached. Use the [Focus Magnifier] function instead.

### Related Topic

- [Manual Focus](#)
- [Direct manual focus \(DMF\)](#)
- [Focus Magnif. Time](#)

Interchangeable Lens Digital Camera  
ILCE-7M3 α7III

## Peaking Setting

---

Sets the peaking function, which enhances the outline of in-focus areas during shooting with Manual Focus or Direct Manual Focus.

1 MENU →  1 (Camera Settings1) → [Peaking Setting] → desired setting.

### Menu item details

**Peaking Display:**

Sets whether to display peaking.

**Peaking Level:**

Sets the level of enhancement of in-focus areas.

**Peaking Color:**

Sets the color used to enhance in-focus areas.

**Note**

- Since the product recognizes sharp areas as in focus, the effect of peaking differs, depending on the subject and lens.
- The outline of in-focus ranges is not enhanced on devices connected via HDMI.

---

### Related Topic



- [Manual Focus](#)
- [Direct manual focus \(DMF\)](#)

Interchangeable Lens Digital Camera  
ILCE-7M3 α7III

## Anti-flicker Shoot. (still image)

Detects flickering/blinking from artificial light sources such as fluorescent lighting and times the shooting of images to moments when flickering will have less of an impact.

This function reduces differences in the exposure and color tone caused by flickering between the upper area and the lower area of an image shot with fast shutter speed and during continuous shooting.

- 1 MENU →  1 (Camera Settings1) → [ Anti-flicker Shoot.] → [On].
- 2 Press the shutter button halfway down, and then shoot the image.
  - The product detects flickering when the shutter button is pressed halfway down.



### Menu item details

- Off:**  
Does not reduce influences caused by flickering.
- On:**  
Reduces influences caused by flickering. When the camera detects flickering while the shutter button is pressed halfway down, **Flicker** (flicker icon) will be displayed.

#### Hint

- The color tone of the shot result may vary when you shoot the same scene using a different shutter speed. If that happens, we recommend that you shoot in [Shutter Priority] or [Manual Exposure] mode with a fixed shutter speed.
- You can perform anti-flicker shooting by pressing the shutter button halfway down even when in manual focus mode.

#### Note

- The shutter release lag may increase slightly. In continuous shooting mode, the shooting speed may slow down or the interval between each shot may become unequal.
- The camera detects flickering when the frequency of the light source is 100 Hz or 120 Hz only.
- The camera cannot detect flickering depending on the light source and shooting conditions, such as a dark background.
- Even if the camera detects flickering, the influences caused by flickering may not be reduced enough depending on the light source or the shooting situation. We recommend that you take test shots beforehand.
- [ Anti-flicker Shoot.] is not available when shooting in the following situations:
  - While bulb shooting
  - [ Silent Shooting]
  - Movie shooting mode
  - When shooting an image without pressing the shutter button halfway down in manual focus mode
- The color tone of the shot results may differ depending on the setting of [ Anti-flicker Shoot.].

Interchangeable Lens Digital Camera  
ILCE-7M3 α7III

## Face Registration (New Registration)

---

If you register faces in advance, the product can focus on the registered face as a priority when [Face Priority in AF] is set to [On].

- 1 MENU →  (Camera Settings1) → [Face Registration] → [New Registration].
- 2 Align the guide frame with the face to be registered, and press the shutter button.
- 3 When a confirmation message appears, select [Enter].

### Note

- Up to eight faces can be registered.
- Shoot the face from the front in a brightly lit place. The face may not be registered correctly if it is obscured by a hat, a mask, sunglasses, etc.

---

### Related Topic

- [Set. Face Prty in AF](#)



Interchangeable Lens Digital Camera  
ILCE-7M3 α7III

## Face Registration (Order Exchanging)

---

When multiple faces are registered to be given priority, the face registered first will be given priority. You can change the priority order.

- 1 MENU →  1 (Camera Settings1) → [Face Registration] → [Order Exchanging].
  - 2 Select a face to change the order of priority.
  - 3 Select the destination.
- 

### Related Topic

- [Set. Face Prty in AF](#)

Interchangeable Lens Digital Camera  
ILCE-7M3 α7III

## Face Registration (Delete)

---

Deletes a registered face.

**1** MENU →  (Camera Settings1) → [Face Registration] → [Delete].

If you select [Delete All], you can delete all registered faces.

### Note

- Even if you execute [Delete], the data for registered face will remain in the product. To delete the data for registered faces from the product, select [Delete All].

Interchangeable Lens Digital Camera  
ILCE-7M3 α7III

## Regist. Faces Priority

---

Sets whether to focus with higher priority on faces registered using [Face Registration] when [Face Priority in AF] is set to [On].

**1** MENU →  1 (Camera Settings1) → [Regist. Faces Priority] → desired setting.

### Menu item details

**On:**

Focuses with higher priority on faces registered using [Face Registration].

**Off:**

Focuses without giving higher priority to registered faces.

---

### Related Topic



- [Set. Face Prty in AF](#)
- [Face Registration \(New Registration\)](#)
- [Face Registration \(Order Exchanging\)](#)

Interchangeable Lens Digital Camera  
ILCE-7M3 α7III

## Movie: Exposure Mode

---

You can set the exposure mode for movie shooting.

- 1 Set the mode dial to  (Movie).
- 2 MENU →  2 (Camera Settings2) → [ Exposure Mode] → desired setting.
- 3 Press the MOVIE (movie) button to start recording.
  - Press the MOVIE button again to stop recording.

### Menu item details

#### Program Auto:

Allows you to shoot with the exposure adjusted automatically (both the shutter speed and the aperture value).

#### Aperture Priority:

Allows you to shoot after adjusting the aperture value manually.

#### Shutter Priority:

Allows you to shoot after adjusting the shutter speed manually.

#### Manual Exposure:

Allows you to shoot after adjusting the exposure (both the shutter speed and the aperture value) manually.

Interchangeable Lens Digital Camera  
ILCE-7M3 α7III

## S&Q Motion: Exposure Mode

---

You can select the exposure mode for slow-motion/quick-motion shooting. You can change the setting and playback speed for slow-motion/quick-motion shooting with [**S&Q** S&Q Settings].

- 1 Set the mode dial to **S&Q** (S&Q Motion).
- 2 MENU →  2 (Camera Settings2) → [**S&Q** Exposure Mode] → desired setting.
- 3 Press the **MOVIE** (movie) button to start recording.
  - Press the **MOVIE** button again to stop recording.

### Menu item details

#### **S&Q** **P** Program Auto:

Allows you to shoot with the exposure adjusted automatically (both the shutter speed and the aperture value).

#### **S&Q** **A** Aperture Priority:

Allows you to shoot after adjusting the aperture value manually.

#### **S&Q** **S** Shutter Priority:

Allows you to shoot after adjusting the shutter speed manually.

#### **S&Q** **M** Manual Exposure:

Allows you to shoot after adjusting the exposure (both the shutter speed and the aperture value) manually.

---



### Related Topic

- [S&Q Settings](#)

Interchangeable Lens Digital Camera  
ILCE-7M3 α7III

## File Format (movie)



Selects the movie file format.

**1** MENU →  2 (Camera Settings2) → [ File Format] → desired setting.

### Menu item details

 File Format	Characteristics	
XAVC S 4K	Records movies in 4K resolution (3840×2160).	You can save movies on a computer using the PlayMemories Home software.
XAVC S HD	Records movies in crisper quality than AVCHD with larger amounts of data.	You can save movies on a computer using the PlayMemories Home software.
AVCHD	The AVCHD format has a high degree of compatibility with storage devices other than computers.	You can save movies on a computer or create a disc that supports this format using the PlayMemories Home software.



#### Note

- When [ File Format] is set to [AVCHD], the file size of movies is limited to approx. 2 GB. If the movie file size reaches approx. 2 GB during recording, a new movie file will be created automatically.
- If you set [ File Format] to [XAVC S 4K] and shoot movies while the camera is connected to an HDMI device, images will not be displayed on the monitor.

Interchangeable Lens Digital Camera  
ILCE-7M3 α7III

## Record Setting (movie)

Selects the frame rate and bit-rate for movie recording.

1 MENU →  2 (Camera Settings2) → [ Record Setting] → desired setting.

- The higher the bit-rate, the higher the image quality.

### Menu item details

When [ File Format] is set to [XAVC S 4K]

 Record Setting	Bit-rate	Description
30p 100M/25p 100M	Approx. 100 Mbps	Records movies in 3840×2160 (30p/25p).
30p 60M/25p 60M	Approx. 60 Mbps	Records movies in 3840×2160 (30p/25p).
24p 100M*	Approx. 100 Mbps	Records movies in 3840×2160 (24p).
24p 60M*	Approx. 60 Mbps	Records movies in 3840×2160 (24p).

\* Only when [NTSC/PAL Selector] is set to NTSC

When [ File Format] is set to [XAVC S HD]

 Record Setting	Bit-rate	Description
60p 50M/50p 50M	Approx. 50 Mbps	Records movies in 1920×1080 (60p/50p).
60p 25M/50p 25M	Approx. 25 Mbps	Records movies in 1920×1080 (60p/50p).
30p 50M/25p 50M	Approx. 50 Mbps	Records movies in 1920×1080 (30p/25p).
30p 16M/25p 16M	Approx. 16 Mbps	Records movies in 1920×1080 (30p/25p).
24p 50M*	Approx. 50 Mbps	Records movies in 1920×1080 (24p).
120p 100M/100p 100M	Approx. 100 Mbps	Records high-speed movies in 1920×1080 (120p/100p). You can record movies in 120 fps or 100 fps. <ul style="list-style-type: none"> <li>• You can create smoother slow-motion movies by using compatible editing devices.</li> </ul>



 Record Setting	Bit-rate	Description
120p 60M/100p 60M	Approx. 60 Mbps	Records high-speed movies in 1920×1080 (120p/100p). You can record movies in 120 fps or 100 fps. <ul style="list-style-type: none"> <li>You can create smoother slow-motion movies by using compatible editing devices.</li> </ul>

\* Only when [NTSC/PAL Selector] is set to NTSC

### When [ File Format] is set to [AVCHD]

 Record Setting	Bit-rate	Description
60i 24M(FX)/50i 24M(FX)	24 Mbps at maximum	Records movies in 1920×1080 (60i/50i).
60i 17M(FH)/50i 17M(FH)	Approx. 17 Mbps on average	Records movies in 1920×1080 (60i/50i).

#### Note

- Creating an AVCHD recording disc from movies that were recorded with [60i 24M(FX)]/[50i 24M(FX)] as the [ Record Setting] takes a long time because the image quality of movies is converted. If you want to store movies without converting them, use a Blu-ray Disc.
- [120p]/[100p] cannot be selected for the following settings.
  - [Intelligent Auto]
  - [Scene Selection]
- In full-frame shooting, the angle of view will be narrower under the following conditions:
  - When [ File Format] is set to [XAVC S 4K] and [ Record Setting] is set to [30p]



#### Related Topic

- [APS-C/Super 35mm](#)
- [Angle of view](#)



## S&Q Settings

You can record a moment that cannot be captured by the naked eye (slow-motion recording), or record a long-term phenomenon into a compressed movie (quick-motion recording). For example, you can record an intense sports scene, the moment when a bird starts to fly, a blooming flower, and a changing view of clouds or a starry sky. Sound will not be recorded.

- 1 Set the mode dial to **S&Q** (S&Q Motion).
- 2 Select MENU →  2 (Camera Settings2) → [ **S&Q** Exposure Mode ] → and select the desired setting of slow-motion/quick-motion ( **S&Q** Program Auto, **S&Q** Aperture Priority, **S&Q** Shutter Priority, or **S&Q** Manual Exposure).
- 3 Select MENU →  2 (Camera Settings2) → [ **S&Q** S&Q Settings ] and select the desired settings for [ **S&Q** Record Setting ] and [ **S&Q** Frame Rate ].
- 4 Press the MOVIE (movie) button to start recording.
  - Press the MOVIE button again to stop recording.

### Menu item details

**S&Q** Record Setting:

Selects the frame rate of the movie.

**S&Q** Frame Rate:

Selects the shooting frame rate.

### Playback speed

The playback speed will vary as below depending on the assigned [ **S&Q** Record Setting ] and [ **S&Q** Frame Rate ].

#### When [NTSC/PAL Selector] is set to NTSC

<b>S&amp;Q</b> Frame Rate	<b>S&amp;Q</b> Record Setting		
	24p	30p	60p
120fps	5 times slower	4 times slower	-
60fps	2.5 times slower	2 times slower	Normal playback speed
30fps	1.25 times slower	Normal playback speed	2 times quick
15fps	1.6 times quick	2 times quick	4 times quick
8fps	3 times quick	3.75 times quick	7.5 times quick
4fps	6 times quick	7.5 times quick	15 times quick
2fps	12 times quick	15 times quick	30 times quick
1fps	24 times quick	30 times quick	60 times quick

## When [NTSC/PAL Selector] is set to PAL

S&Q Frame Rate	S&Q Record Setting	
	25p	50p
100fps	4 times slower	-
50fps	2 times slower	Normal playback speed
25fps	Normal playback speed	2 times quick
12fps	2.08 times quick	4.16 times quick
6fps	4.16 times quick	8.3 times quick
3fps	8.3 times quick	16.6 times quick
2fps	12.5 times quick	25 times quick
1fps	25 times quick	50 times quick

- When [S&Q Frame Rate] is set to [120fps]/[100fps], you cannot set [S&Q Record Setting] to [60p]/[50p].

### Note

- In slow-motion recording, the shutter speed becomes faster and you may not be able to obtain the proper exposure. If this happens, decrease the aperture value or adjust the ISO sensitivity to a higher value.
- For an estimation of recordable time, refer to "Recordable movie times."
- The bit-rate of a recorded movie varies depending on the settings for [S&Q Frame Rate] and [S&Q Record Setting].
- The movie will be recorded in XAVC S HD format.
- During slow-motion/quick-motion recording, the following functions are not available.
  - [TC Run] under [TC/UB Settings]
  - [TC Output] under [HDMI Settings]
  - [4K Output Sel.]

### Related Topic

- [S&Q Motion: Exposure Mode](#)
- [Recordable movie times](#)

Interchangeable Lens Digital Camera  
ILCE-7M3 α7III

## Proxy Recording

Sets whether to simultaneously record low-bit-rate proxy movies when recording XAVC S movies. Since proxy movies are small in file size, they are suitable for transferring to smartphones or uploading to websites.

1 MENU →  2 (Camera Settings2) → [**Px** Proxy Recording] → desired setting.

### Menu item details

#### On :

Proxy movies are simultaneously recorded.



#### Off :

Proxy movies are not recorded.

#### Hint

- Proxy movies are recorded in the XAVC S HD format (1280×720) at 9 Mbps. The frame rate of the proxy movie is the same as that of the original movie.
- Proxy movies are not displayed on the playback screen (single-image playback screen or image index screen). **Px** is displayed over movies for which a proxy movie was simultaneously recorded.

#### Note

- Proxy movies cannot be played back on this camera.
- Proxy recording is not available in the following situations.
  - When [ File Format] is set to [AVCHD]
  - When [ File Format] is set to [XAVC S HD] and [ Record Setting] is set to [120p]/[100p]
- Deleting/protecting movies that have proxy movies removes/protects both the original and proxy movies. You cannot delete/protect only original movies or proxy movies.
- Movies cannot be edited on this camera.

### Related Topic



- [Snd to Smrtphn Func: Sending Target \(proxy movies\)](#)
- [Movie recording formats](#)
- [Playing back images on the image index screen \(Image Index\)](#)
- [Memory cards that can be used](#)

Interchangeable Lens Digital Camera  
ILCE-7M3 α7III

## AF drive speed (movie)

---

You can switch focusing speed when using autofocus in movie mode.

**1** MENU →  2 (Camera Settings2) → [ AF drive speed] → desired setting.

### Menu item details

**Fast:**

Sets the AF drive speed to fast. This mode is suitable for shooting active scenes, such as sports.

**Normal:**

Sets the AF drive speed to normal.

**Slow:**



Sets the AF drive speed to slow. With this mode, the focus switches smoothly when the subject to be focused is changed.

Interchangeable Lens Digital Camera  
ILCE-7M3 α7III

## AF Track Sens (movie)

---

You can set the AF sensitivity in movie mode.

**1** MENU →  2 (Camera Settings2) → [ AF Track Sens] → desired setting.

### Menu item details

**Responsive:**

Sets the AF sensitivity to high. This mode is useful when recording movies in which the subject is moving quickly.



**Standard:**

Sets the AF sensitivity to normal. This mode is useful when there are obstacles in front of the subject or in crowded places.

Interchangeable Lens Digital Camera  
ILCE-7M3 α7III

## Auto Slow Shut. (movie)

Sets whether or not to adjust the shutter speed automatically when recording movies if the subject is dark.

1 MENU →  2 (Camera Settings2) → [ Auto Slow Shut.] → desired setting.

### Menu item details



#### On:

Uses Auto Slow Shutter. The shutter speed automatically slows when recording in dark locations. You can reduce noise in the movie by using a slow shutter speed when recording in dark locations.

#### Off:

Does not use Auto Slow Shutter. The recorded movie will be darker than when [On] is selected, but you can record movies with smoother motion and less object blur.

#### Note

- [ Auto Slow Shut.] does not function in the following situations:
  - During slow-motion/quick-motion shooting
  -  (Shutter Priority)
  -  (Manual Exposure)
  - When [ISO] is set to other than [ISO AUTO]

Interchangeable Lens Digital Camera  
ILCE-7M3 α7III

## Audio Recording

---

Sets whether to record sounds when shooting movies. Select [Off] to avoid recording the sounds of the lens and the camera operating.

**1** MENU →  2 (Camera Settings2) → [Audio Recording] → desired setting.

### Menu item details

**On:**

Records sound (stereo).

**Off:**

Does not record sound.

Interchangeable Lens Digital Camera  
ILCE-7M3 α7III

## Audio Rec Level

---

You can adjust the audio recording level while checking the level meter.

- 1 MENU →  2 (Camera Settings2) → [Audio Rec Level].
- 2 Select the desired level using the right/left sides of the control wheel.

### Menu item details

+:

Turns up the audio recording level.

-:

Turns down the audio recording level.

**Reset:**

Resets the audio recording level to the default setting.

#### Hint

- When you record audio movies with loud volumes, set [Audio Rec Level] to a lower sound level. Doing so enables you to record more realistic audio. When you record audio movies with lower volumes, set [Audio Rec Level] to a greater sound level to make the sound easier to hear.

#### Note

- Regardless of the [Audio Rec Level] settings, the limiter always operates.
- [Audio Rec Level] is available only when the shooting mode is set to movie mode.
- [Audio Rec Level] is unavailable during slow-motion/quick-motion shooting.
- The [Audio Rec Level] settings are applied for both the internal microphone and the  (microphone) terminal input.



Interchangeable Lens Digital Camera  
ILCE-7M3 α7III

## Audio Level Display

---

Sets whether to display the audio level on the screen.

**1** MENU →  2 (Camera Settings2) → [Audio Level Display] → desired setting.

### Menu item details

**On:**

Displays the audio level.

**Off:**

Does not display the audio level.

**Note**

- The audio level is not displayed in the following situations:
  - When [Audio Recording] is set to [Off].
  - When DISP (Display Setting) is set to [No Disp. Info].
  - During slow-motion/quick-motion shooting
- The audio level is also displayed while shooting stand-by in movie recording mode.

Interchangeable Lens Digital Camera  
ILCE-7M3 α7III

## Audio Out Timing

---

You can set echo cancellation during audio monitoring and prevent undesirable deviations between video and audio during HDMI output.

**1** MENU →  2 (Camera Settings2) → [Audio Out Timing] → desired setting.

### Menu item details

**Live:**

Outputs audio without delay. Select this setting when audio deviation is a problem during audio monitoring.

**Lip Sync:**

Outputs audio and video in sync. Select this setting to prevent undesirable deviations between video and audio.

Interchangeable Lens Digital Camera  
ILCE-7M3 α7III

## Wind Noise Reduct.

---

Sets whether or not to reduce wind noise by cutting the low-range sound of the input audio from the built-in microphone.

**1** MENU →  2 (Camera Settings2) → [Wind Noise Reduct.] → desired setting.

### Menu item details

**On:**

Reduces wind noise.

**Off:**

Does not reduce wind noise.

**Note**



- Setting this item to [On] where wind is not blowing sufficiently hard may cause normal sound to be recorded with too low volume.
- When an external microphone (sold separately) is used, [Wind Noise Reduct.] does not function.

Interchangeable Lens Digital Camera  
ILCE-7M3 α7III

## Marker Display (movie)

---

Sets whether or not to display markers set using [ Marker Settings] on the monitor or the viewfinder while shooting movies.

1 MENU →  2 (Camera Settings2) → [ Marker Display] → desired setting.

### Menu item details

**On:**

Markers are displayed. The markers are not recorded.

**Off:**

No marker is displayed.

**Note**

- The markers are displayed when the mode dial is set to  (Movie) or **S&Q**, or when shooting movies.
- You cannot display markers when using [Focus Magnifier].
- The markers are displayed on the monitor or viewfinder. (You cannot output the markers.)

---

### Related Topic



- [Marker Settings \(movie\)](#)

Interchangeable Lens Digital Camera  
ILCE-7M3 α7III

## Marker Settings (movie)

---

Sets the markers to be displayed while shooting movies.

1 MENU →  2 (Camera Settings2) → [ Marker Settings] → desired setting.

### Menu item details

**Center:**

Sets whether or not to display the center marker in the center of the shooting screen.

[Off]/[On]

**Aspect:**

Sets the aspect marker display.

[Off]/[4:3]/[13:9]/[14:9]/[15:9]/[1.66:1]/[1.85:1]/[2.35:1]

**Safety Zone:**

Sets the safety zone display. This becomes the standard range that can be received by a general household TV.

[Off]/[80%]/[90%]

**Guideframe:**

Sets whether or not to display the guide frame. You can verify whether the subject is level or perpendicular to the ground.

[Off]/[On]

**Hint**

- You can display several markers at the same time.
- Place the subject on the cross point of the [Guideframe] to make a balanced composition.

Interchangeable Lens Digital Camera  
ILCE-7M3 α7III

## Video Light Mode

---

Sets the illumination setting for the HVL-LBPC LED light (sold separately).

**1** MENU →  2 (Camera Settings2) → [Video Light Mode] → desired setting.

### Menu item details

**Power Link:**

The video light turns on/off in sync with the ON/OFF operation of this camera.

**REC Link:**

The video light turns on/off in sync with movie recording start/stop.

**REC Link&STBY:**

The video light turns on when movie recording starts and dims when not recording (STBY).

**Auto:**

The video light automatically turns on when it is dark.

Interchangeable Lens Digital Camera  
ILCE-7M3 α7III

## Movie w/ shutter

---

You can start or stop recording movies by pressing the shutter button, which is bigger and easier to press than the MOVIE (Movie) button.

1 MENU →  2 (Camera Settings2) → [Movie w/ shutter] → desired setting.

### Menu item details

**On:**

Enables movie recording using the shutter button when the shooting mode is set to [Movie] or [S&Q Motion].

**Off:**

Disables movie recording using the shutter button.

**Hint**

- When [Movie w/ shutter] is set to [On], you can still start or stop recording movies using the MOVIE button.
- When [Movie w/ shutter] is set to [On], you can use the shutter button to start or stop recording movies on an external recording/playback device using [ REC Control].

**Note**

- When [Movie w/ shutter] is set to [On], you cannot focus by pressing the shutter button halfway down during movie recording.

---



### Related Topic

- [Shooting movies](#)

Interchangeable Lens Digital Camera  
ILCE-7M3 α7III

## Silent Shooting (still image)

You can shoot images without the shutter sound.

1 MENU →  2 (Camera Settings2) → [ Silent Shooting] → desired setting.

### Menu item details













#### On:

You can shoot images without the shutter sound.

#### Off:

[ Silent Shooting] is deactivated.

#### Note

- Use the [ Silent Shooting] function on your own responsibility, while taking sufficient consideration to the privacy and portrait rights of the subject.
- Even if [ Silent Shooting] is set to [On], it will not be completely silent.
- Even if [ Silent Shooting] is set to [On], the operating sound of the aperture and focus will sound.
- When shooting still images using the [ Silent Shooting] function with low ISO sensitivity, if you point the camera at a very bright light source, high intensity areas on the monitor may be recorded in darker tones.
- When the power is turned off, the shutter sound may beep in rare occasions. This is not a malfunction.
- Image distortion caused by the movement of the subject or the camera may occur. The distortion may become more noticeable when [ RAW File Type] is set to [Uncompressed]. To decrease the distortion, set [ File Format] to [JPEG]. If you want to shoot images in the RAW format with less distortion, set [Drive Mode] to [Cont. Shooting] and [ RAW File Type] to [Compressed].
- If you shoot images under instantaneous lightning or flickering lights, such as the flash light from other cameras or fluorescent lighting, a striping effect may occur on the image.
- If you want to turn off the beep that sounds when the subject is in focus or the self-timer operates, set [Audio signals] to [Off].
- Even if [ Silent Shooting] is set to [On], the shutter sound may beep under the following circumstances:
  - When you capture a basic white color while the camera is set to the [Custom Setup] mode under [White Balance]
  - When you register faces using [Face Registration]
- You cannot select [ Silent Shooting] when the mode dial is set to other than P/A/S/M.
- When [ Silent Shooting] is set to [On], the following functions are not available:
  - Flash shooting
  - Auto HDR
  - Picture Effect
  - Picture Profile
  -  Long Exposure NR
  - e-Front Curtain Shut.
  - BULB shooting
- After you turn the camera on, the time in which you can start recording is extended by approximately 0.5 seconds.
- Bracket shooting is unavailable during silent shooting when [ File Format] is set to [RAW] or [RAW & JPEG] and [ RAW File Type] is set to [Uncompressed].





Interchangeable Lens Digital Camera  
ILCE-7M3 α7III

## e-Front Curtain Shut.

The electronic front curtain shutter function shortens the time lag between when the shutter button is pressed and the shutter is released.

1 MENU →  2 (Camera Settings2) → [e-Front Curtain Shut.] → desired setting.

### Menu item details

#### On:

Uses the electronic front curtain shutter function.

#### Off:

Does not use the electronic front curtain shutter function.

#### Note

- When you shoot at high shutter speeds with a large-aperture lens attached, out-of-focus circle produced by the bokeh effect may get cut off because of the shutter mechanism. If this happens, set [e-Front Curtain Shut.] to [Off].
- When a lens made by another manufacturer (including a Minolta/Konica-Minolta lens) is used, set this function to [Off]. If you set this function to [On], the correct exposure will not be set or the image brightness will be uneven.
- When you shoot at high shutter speeds, the image brightness may become uneven depending on the shooting environment. In such cases, set [e-Front Curtain Shut.] to [Off].

Interchangeable Lens Digital Camera  
ILCE-7M3 α7III

## Release w/o Lens

---

Sets whether or not the shutter can be released when no lens is attached.

**1** MENU →  2 (Camera Settings2) → [Release w/o Lens] → desired setting.

### Menu item details

**Enable:**

Releases the shutter when no lens is attached. Select [Enable] when attaching the product to an astronomical telescope, etc.

**Disable:**

Does not release the shutter when a lens is not attached.

**Note**

- Correct metering cannot be achieved when you use lenses that do not provide a lens contact, such as the lens of an astronomical telescope. In such cases, adjust the exposure manually by checking it on the recorded image.

Interchangeable Lens Digital Camera  
ILCE-7M3 α7III

## Release w/o Card

---

Sets whether the shutter can be released when no memory card has been inserted.

**1** MENU →  2 (Camera Settings2) → [Release w/o Card] → desired setting.

### Menu item details

**Enable:**

Releases the shutter even if no memory card has been inserted.

**Disable:**

Does not release the shutter when no memory card has been inserted.

**Note**

- When no memory card has been inserted, the images shot will not be saved.
- The default setting is [Enable]. It is recommended that you select [Disable] prior to actual shooting.

Interchangeable Lens Digital Camera  
ILCE-7M3 α7III

## SteadyShot

---

Sets whether or not to use the SteadyShot function.

**1** MENU →  **2** (Camera Settings2) → [SteadyShot] → desired setting.

### Menu item details

**On:**

Uses [SteadyShot].

**Off:**

Does not use [SteadyShot].

We recommend that you set [Off] when using a tripod, etc.

Interchangeable Lens Digital Camera  
ILCE-7M3 α7III

## SteadyShot Settings

You can shoot with an appropriate SteadyShot setting for the attached lens.

- 1 MENU →  2 (Camera Settings2) → [SteadyShot] → [On].
- 2 [SteadyShot Settings] → [SteadyShot Adjust.] → desired setting.

### Menu item details

#### Auto:

Performs the SteadyShot function automatically according to the information obtained from the attached lens.



#### Manual:

Performs the SteadyShot function according to the focal-length set using [SteadyS. Focal Len.]. (8mm-1000mm)

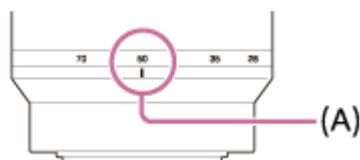
- Check the focal-length index (A) and set the focal-length.



### Note

- The SteadyShot function may not work optimally when the power has just been turned on, right after you point the camera towards a subject, or when the shutter button has been pressed all the way down without stopping halfway.
- When using a tripod, etc., make sure to turn off the SteadyShot function because this can cause any malfunction when shooting.
- [SteadyShot Settings] will be unavailable when MENU →  2 (Camera Settings2) → [SteadyShot] is set to [Off].
- When the camera cannot obtain focal length information from the lens, the SteadyShot function does not work correctly. Set [SteadyShot Adjust.] to [Manual] and set [SteadyS. Focal Len.] to match the lens you are using. The current set value of the SteadyShot focal length will display to the side of .
- When using an SEL16F28 lens (sold separately) with a teleconverter, etc., set [SteadyShot Adjust.] to [Manual] and set the focal length.
- When you set [SteadyShot] to [On]/[Off], the SteadyShot settings of the camera and lens switch at the same time.
- If a lens equipped with a SteadyShot switch is attached, the settings can only be changed using that switch on the lens. You cannot switch the settings using the camera.

### Related Topic



- [SteadyShot](#)

Interchangeable Lens Digital Camera  
ILCE-7M3 α7III



## Clear Image Zoom/Digital Zoom (Zoom)

---

When you use a zoom function other than the optical zoom, you can exceed the zoom range of the optical zoom.

- 1 MENU →  (Camera Settings2) → [Zoom Setting] → [On:ClearImage Zoom] or [On:Digital Zoom].
- 2 When a power zoom lens is mounted, move the zoom lever or the zoom ring of the zoom lens to enlarge subjects.
  - When you exceed the zoom range of the optical zoom, the camera automatically switches to another zoom than the optical zoom.
- 3 When a lens other than a power zoom lens is mounted, select MENU →  (Camera Settings2) → [Zoom] → desired value.

Press the center of the control wheel to exit.

  - You can also assign the [Zoom] function to the desired button by selecting MENU →  (Camera Settings2) → [ Custom Key] or [ Custom Key].

---

### Related Topic

- [Zoom Setting](#)
- [The zoom features available with this product](#)
- [Custom Key \(still image/movie/playback\)](#)

Interchangeable Lens Digital Camera  
ILCE-7M3 α7III

## Zoom Setting

---

You can select the zoom setting of the product.

**1** MENU →  2 (Camera Settings2) → [Zoom Setting] → desired setting.

### Menu item details

#### Optical zoom only:

Limits the zoom range to the optical zoom. You can use the Smart Zoom function if you set [  JPEG Image Size] to [M] or [S].

#### On:ClearImage Zoom:

Select this setting to use Clear Image Zoom. Even if the zoom range exceeds the optical zoom, the product magnifies images within the range in which image quality does not deteriorate significantly.

#### On:Digital Zoom:

When the zoom range of the Clear Image Zoom is exceeded, the product magnifies images to the largest scale. However, the image quality will deteriorate.

#### Note

- Set [Optical zoom only] if you want to magnify images within the range in which image quality does not deteriorate.

---

### Related Topic

- [The zoom features available with this product](#)
- [About zoom scale](#)



Interchangeable Lens Digital Camera  
ILCE-7M3 α7III

## Zoom Ring Rotate

---

Assigns zoom in (T) or zoom out (W) functions to the zoom ring rotation direction. Available only with power zoom lenses that support this function.

**1** MENU →  **2** (Camera Settings2) → [Zoom Ring Rotate] → desired setting.

### Menu item details

#### **Left(W)/Right(T):**

Assigns zoom out (W) function to left-handed rotation and zoom-in (T) function to right-handed rotation.

#### **Right(W)/Left(T):**

Assigns zoom in (T) function to left-handed rotation and zoom-out (W) function to right-handed rotation.

## DISP Button (Monitor/Finder)

Allows you to set the screen display modes that can be selected using DISP (Display Setting) in shooting mode.

1 MENU →  2 (Camera Settings2) → [DISP Button] → [Monitor] or [Finder] → desired setting → [Enter].

The items marked with  are available.

### Menu item details

#### Graphic Display :

Shows basic shooting information. Graphically shows the shutter speed and aperture value.

#### Display All Info. :

Shows recording information.

#### No Disp. Info. :

Does not show recording information.

#### Histogram :

Displays the luminance distribution graphically.

#### Level :

Indicates whether the product is level in both the front-back **(A)** and horizontal **(B)** directions. When the product is level in either direction, the indicator turns to green.

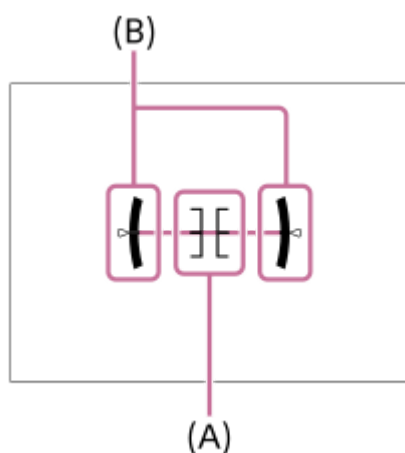

#### For viewfinder\*:

Displays only shooting information on the monitor, not the subject. This setting is a display setting for shooting with the viewfinder.

#### Monitor Off\*:

Always turns the monitor off when shooting images. You can use the monitor when playing back images or operating MENU. This setting is a display setting for shooting with the viewfinder.

\* These screen modes are available only in the setting for [Monitor].

### Note

- If you tilt the product forward or backward by a large degree, the level error will be great.
- The product may have a margin of error of almost  $\pm 1^\circ$  even when the inclination is corrected by the level.

---

---

## Related Topic

- [Switching the screen display \(while shooting/during playback\)](#)

4-732-947-11(1) Copyright 2018 Sony Corporation

Interchangeable Lens Digital Camera  
ILCE-7M3 α7III

## FINDER/MONITOR

Sets the method for switching the display between Electronic Viewfinder and the screen.

1 MENU →  2 (Camera Settings2) → [FINDER/MONITOR] → desired setting.

### Menu item details

#### Auto:

When you look into the Electronic Viewfinder, the eye sensor reacts and the display is switched to the Electronic Viewfinder automatically.





#### Viewfinder(Manual):

The screen is turned off and the image is displayed only in the Electronic Viewfinder.

#### Monitor(Manual):

The Electronic Viewfinder is turned off and the image is always displayed on the screen.

#### Hint

- You can assign the [FINDER/MONITOR] function to your preferred key.  
MENU →  2 (Camera Settings2) → [ Custom Key], [ Custom Key] or [ Custom Key] → set [Finder/Monitor Sel.] to the preferred key.
- If you want to retain the Electronic Viewfinder display or the monitor display, set [FINDER/MONITOR] to [Viewfinder(Manual)] or [Monitor(Manual)] beforehand.  
You can keep the monitor off when you take your eyes off the Electronic Viewfinder during recording by setting the monitor display to [Monitor Off] using the DISP button. Select MENU →  2 (Camera Settings2) → [DISP Button] → [Monitor] and add a check mark to [Monitor Off] beforehand.

#### Note

- When the monitor is pulled out, the eye sensor of the camera will not detect your eye approaching even if [FINDER/MONITOR] is set to [Auto]. The image will continue to be displayed on the monitor.

### Related Topic

- [Custom Key \(still image/movie/playback\)](#)
- [DISP Button \(Monitor/Finder\)](#)

Interchangeable Lens Digital Camera  
ILCE-7M3 α7III

## Zebra Setting

Sets a zebra pattern, which appears over part of an image if the brightness level of that part meets the IRE level that you have set. Use this zebra pattern as a guide to adjust the brightness.

1 MENU →  2 (Camera Settings2) → [Zebra Setting] → desired setting.

### Menu item details

#### Zebra Display:

Sets whether to display the zebra pattern.

#### Zebra Level:

Adjusts the brightness level of the zebra pattern.

#### Hint

- You can register values to check the correct exposure or overexposure as well as the brightness level for [Zebra Level]. The settings for correct exposure confirmation and overexposure confirmation are registered to [Custom1] and [Custom2] respectively in the default settings.
- To check the correct exposure, set a standard value and the range for the brightness level. The zebra pattern will appear on areas that fall within the range you set.
- To check the overexposure, set a minimum value for the brightness level. The zebra pattern will appear over areas with a brightness level equal to or higher than the value you set.

#### Note

- The zebra pattern is not displayed on devices connected via HDMI.

Interchangeable Lens Digital Camera  
ILCE-7M3 α7III

## Grid Line

---

Sets whether the grid line is displayed or not. The grid line will help you to adjust the composition of images.

**1** MENU →  2 (Camera Settings2) → [Grid Line] → **desired setting.**

### Menu item details

#### Rule of 3rds Grid:

Place main subjects close to one of the grid lines that divide the image into thirds for a well-balanced composition.

#### Square Grid:

Square grids make it easier to confirm the horizontal level of your composition. This is suitable to determine the quality of the composition when shooting landscape, close-up, or duplicated images.

#### Diag. + Square Grid:

Place a subject on the diagonal line to express an uplifting and powerful feeling.

#### Off:

Does not display the grid line.

Interchangeable Lens Digital Camera  
ILCE-7M3 α7III

## Exposure Set. Guide

---

You can set whether to display a guide when you change the exposure.

**1** MENU →  2 (Camera Settings2) → [Exposure Set. Guide] → desired setting.

### Menu item details

**Off:**

Does not display the guide.

**On:**

Displays the guide.

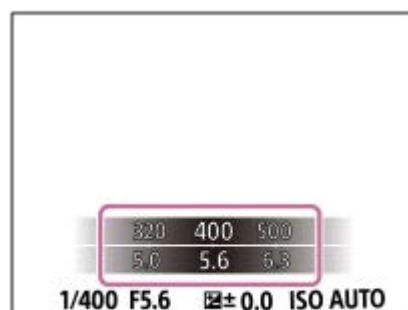

Interchangeable Lens Digital Camera  
ILCE-7M3 α7III

## Live View Display

Sets whether or not to show images altered with effects of the exposure compensation, white balance, [Creative Style], or [Picture Effect] on the screen.

1 MENU →  2 (Camera Settings2) → [Live View Display] → desired setting.

### Menu item details

#### Setting Effect ON:

Displays Live View in conditions close to what your picture will look like as a result of applying all your settings. This setting is useful when you want to shoot pictures while checking the results of the shot on the Live View screen.

#### Setting Effect OFF:

Displays Live View without the effects of exposure compensation, white balance, [Creative Style], or [Picture Effect]. When this setting is used, you can easily check the image composition.

Live View is always displayed with the appropriate brightness even in [Manual Exposure] mode.

When [Setting Effect OFF] is selected, the **VIEW** icon is displayed on the Live View screen.

#### Hint

- When you use a third-party flash, such as a studio flash, Live View Display may be dark for some shutter speed settings. When [Live View Display] is set to [Setting Effect OFF], Live View Display will be displayed brightly, so that you can easily check the composition.

#### Note

- [Live View Display] cannot be set to [Setting Effect OFF] in the following shooting modes:
  - [Intelligent Auto]
  - [Movie]
  - [S&Q Motion]
  - [Scene Selection]
- When [Live View Display] is set to [Setting Effect OFF], the brightness of the shot image will not be the same as that of the displayed Live View.



Interchangeable Lens Digital Camera  
ILCE-7M3 α7III

## Displaying continuous shooting remaining time indicator (Cont. Shoot. Length)

Sets whether to display an indicator of the remaining time for which continuous shooting can be performed at the same shooting speed.

1 MENU →  2 (Camera Settings2) → [Cont. Shoot. Length] → desired setting.

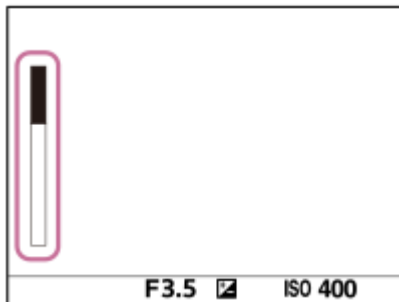

### Menu item details

#### Always Display:

Always displays the indicator when the drive mode is set to [Cont. Shooting].

#### Shoot.-Only Display:

Displays the indicator only while continuous shooting is performed.

#### Not Displayed:

Does not display the indicator.

#### Hint

- When the internal camera memory for buffering is full, "SLOW" will be displayed and the continuous shooting speed will decrease.

### Related Topic

- [Cont. Shooting](#)

Interchangeable Lens Digital Camera  
ILCE-7M3 α7III

## Auto Review

---

You can check the recorded image on the screen right after the shooting. You can also set the display time for Auto Review.

1 MENU →  2 (Camera Settings2) → [Auto Review] → desired setting.

### Menu item details

#### 10 Sec/5 Sec/2 Sec:

Displays the recorded image on the screen right after shooting for the selected duration of time. If you perform a magnifying operation during Auto Review, you can check that image using the magnified scale.

#### Off:

Does not display the Auto Review.

#### Note

- When you use a function that performs image processing, the image before processing may be displayed temporarily, followed by the image after processing.
- The DISP (Display Setting) settings are applied for the Auto Review display.

---

### Related Topic

- [Enlarging an image being played back \(Enlarge Image\)](#)

Interchangeable Lens Digital Camera  
ILCE-7M3 α7III

## Custom Key (still image/movie/playback)

You can assign a desired function to a desired key.

Some functions are available only when they are assigned to a custom key. For example, if you assign [Eye AF] to [Center Button] for [📷 Custom Key], you can easily recall [Eye AF] simply by pressing the center of the control wheel while shooting.

**1** MENU → 📷 2 (Camera Settings2) → [📷 Custom Key], [📺 Custom Key] or [▶ Custom Key].

**2** Select the key to which you want to assign the function on the selection screen, and press the center of the control wheel.

- The keys that can be assigned functions are different for [📷 Custom Key], [📺 Custom Key] and [▶ Custom Key].
- You can assign the desired functions to the following keys.

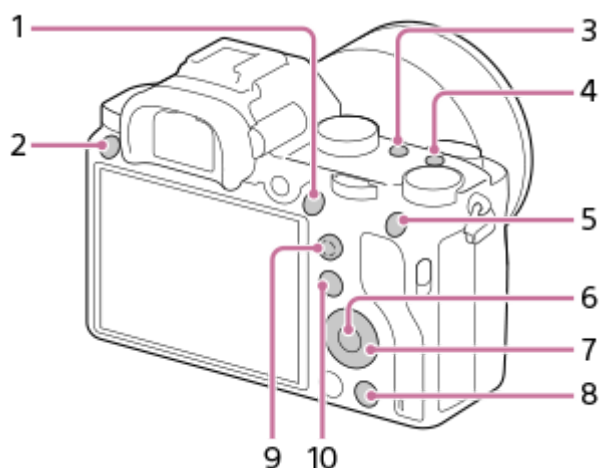

1. AF-ON Button
2. Custom Button 3
3. Custom Button 2
4. Custom Button 1
5. AEL Button
6. Center Button
7. Control Wheel/Down Button/Left Button/Right Button
8. Custom Button 4
9. Multi-Slc Center Btn
10. Fn/📷 Button

- You can also assign a shooting function to the focus hold button on the lens. However, some lenses do not have a focus hold button.

**3** Select the function to be assigned.

- The functions that can be assigned differ depending on the keys.

### Menu item details

 **Custom Key:**

Sets the custom key function to use when shooting still images.

 **Custom Key:**

Sets the custom key function to use when recording movies. You can assign a different function from the one used when shooting still images.

 **Custom Key:**

Sets the custom key function to use when playing back images.

---

**Related Topic**

- [Using the control wheel](#)
- [Using the multi-selector](#)
- [Focus Standard](#)

Interchangeable Lens Digital Camera  
ILCE-7M3 α7III

## Function Menu Set.

---

You can assign the functions to be called up when you press the Fn (Function) button.

- 1 **MENU** →  **2 (Camera Settings2)** → **[Function Menu Set.]** → **set a function to the desired location.**
  - The functions that can be assigned are displayed on the setup item selection screen.

Interchangeable Lens Digital Camera  
ILCE-7M3 α7III

## Dial Setup

---

You can switch the functions of the front/rear dial.

1 MENU →  2 (Camera Settings2) → [Dial Setup] → desired setting.

### Menu item details

 Tv  Av:

The front dial is used to change the shutter speed and the rear dial to change the aperture value.

 Av  Tv:

The front dial is used to change the aperture value and the rear dial to change the shutter speed.

#### Note

- The [Dial Setup] function is enabled when the shooting mode is set to "M."

Interchangeable Lens Digital Camera  
ILCE-7M3 α7III

## Av/Tv Rotate

---

Sets the direction of rotation for the front dial, rear dial, or control wheel when changing the aperture value or shutter speed.

**1** MENU →  **2** (Camera Settings2) → [Av/Tv Rotate] → **desired setting.**

### Menu item details

**Normal:**

Does not change the direction of rotation for the front dial, rear dial, or control wheel.

**Reverse:**

Reverses the direction of rotation for the front dial, rear dial, or control wheel.

Interchangeable Lens Digital Camera  
ILCE-7M3 α7III

## Dial Ev Comp

---

You can adjust the exposure using the front dial or rear dial when the exposure compensation dial is set to "0." You can adjust the exposure in a range of -5.0 EV to +5.0 EV.

- 1 Set the exposure compensation dial to "0."
- 2 MENU →  2 (Camera Settings2) → [Dial Ev Comp] → desired setting.

### Menu item details

#### Off:

Does not enable exposure compensation with the front or rear dial.

#### Front dial/ Rear dial:

Enables exposure compensation with the front or rear dial.

#### Note

- When the exposure compensation function is assigned to the front or rear dial, any function that had been assigned to that dial previously is re-assigned to another dial.
- The settings of the exposure compensation dial will be prioritized over [Exposure Comp.] in MENU or the exposure settings using the front or rear dial.

---

### Related Topic

- [Exposure Comp.](#)



Interchangeable Lens Digital Camera  
ILCE-7M3 α7III

## MOVIE Button

---

Sets whether or not to activate the MOVIE (Movie) button.

**1** MENU →  2 (Camera Settings2) → [MOVIE Button] → desired setting.

### Menu item details

**Always:**

Starts movie recording when you press the MOVIE button in any mode.

**Movie Mode Only:**

Starts movie recording when you press the MOVIE button only if the shooting mode is set to [Movie] or [S&Q Motion] mode.

Interchangeable Lens Digital Camera  
ILCE-7M3 α7III

## Lock Operation Parts

You can set whether the multi-selector, dials, and wheel can be locked by pressing and holding down the Fn (Function) button.

1 MENU →  2 (Camera Settings2) → [Lock Operation Parts] → desired setting.

- To lock the operating parts, hold down the Fn (function) button until the message “Locked.” appears on the monitor.

### Menu item details

#### Off:

Does not lock the multi-selector, front dial, rear dial, or control wheel even if you press and hold down the Fn (Function) button.

#### Multi-Selector Only:

Locks the multi-selector.

#### Dial + Wheel:

Locks the front dial, rear dial, and control wheel.

#### All:

Locks the multi-selector, front dial, rear dial, and control wheel.

#### Hint

- You can release the lock by holding the Fn (Function) button down again.

#### Note

- If you set [ AF Area Regist.] to [On], [Lock Operation Parts] will be fixed to [Off].

### Related Topic

- [Registering the current focus area \(AF Area Regist.\) \(still image\)](#)

Interchangeable Lens Digital Camera  
ILCE-7M3 α7III

## Audio signals

---

Selects whether the product produces a sound or not.

**1** MENU →  **2** (Camera Settings2) → [Audio signals] → desired setting.

### Menu item details

**On:**

Sounds are produced for example when the focus is achieved by pressing the shutter button halfway down.

**Off:**

Sounds are not produced.

**Note**

- If [Focus Mode] is set to [Continuous AF], the camera will not beep when it focuses on a subject.

Interchangeable Lens Digital Camera  
ILCE-7M3 α7III

## Snd to Smrtphn Func: Send to Smartphone

You can transfer still images, XAVC S movies, slow-motion movies, or quick-motion movies to a smartphone and view them. The application PlayMemories Mobile must be installed on your smartphone.

**1 MENU** →  (**Network**) → [**Snd to Smrtphn Func**] → [**Send to Smartphone**] → **desired setting**.

- If you press the  (Send to Smartphone) button in playback mode, the setting screen for [Send to Smartphone] will appear.

**2 If the product is ready for the transfer, the information screen appears on the product. Connect the smartphone and the product using that information.**

- The setting method for connecting the smartphone and the product varies depending on the smartphone.



### Menu item details

#### Select on This Device:

Selects an image on the product to be transferred to the smartphone.

(1) Select from among [This Image], [All with this date] or [Multiple Images].

- The options displayed may differ depending on the View Mode selected on the camera.

(2) If you select [Multiple Images], select the desired images using the center of the control wheel, then press MENU → [Enter].

#### Select on Smartphone:

Displays all images recorded on the product's memory card on the smartphone.

#### Note

- You can only transfer images that are saved on the camera's memory card.
- You can only transfer images that are saved on the memory card in the memory card slot being played back. To change which memory card slot is being played back, select MENU →  (Playback) → [Select PB Media] → the desired slot.
- You can select an image size to be sent to the smartphone from [Original], [2M] or [VGA]. To change the image size, refer to the following steps.
  - For Android smartphone  
Start PlayMemories Mobile, and change the image size by [Settings] → [Copy Image Size].
  - For iPhone/iPad  
Select PlayMemories Mobile in the setting menu, and change the image size by [Copy Image Size].
- RAW images are converted to JPEG format when they are sent.
- You cannot send AVCHD format movies.

- You cannot transfer XAVC S 4K movies or the original data of XAVC S HD movies recorded in [120p]/[100p] to a smartphone. You can only transfer proxy movies.
- Depending on the smartphone, the transferred movie may not be played back correctly. For example, the movie may not play smoothly, or there may be no sound.
- Depending on the format of the still image, movie, slow-motion movie, or quick-motion movie, it may not be possible to play it back on a smartphone.
- This product shares the connection information for [Send to Smartphone] with a device that has permission to connect. If you want to change the device that is permitted to connect to the product, reset the connection information by following these steps. MENU →  (Network) → [Wi-Fi Settings] → [SSID/PW Reset]. After resetting the connection information, you must register the smartphone again.
- When [Airplane Mode] is set to [On], you cannot connect this product and the smartphone. Set [Airplane Mode] to [Off].
- While you transfer many images or long movies, we recommend that you supply power to the camera from a wall outlet (wall socket) using the AC Adaptor (supplied).

---

## Related Topic

- [PlayMemories Mobile](#)
- [Controlling the camera using an Android smartphone \(NFC One-touch remote\)](#)
- [Controlling the camera using an Android smartphone \(QR code\)](#)
- [Controlling the camera using an Android smartphone \(SSID\)](#)
- [Controlling the camera using an iPhone or iPad \(QR code\)](#)
- [Controlling the camera using an iPhone or iPad \(SSID\)](#)
- [Sending images to an Android smartphone \(NFC One-touch Sharing\)](#)
- [Send to Smartphone Func: Sending Target \(proxy movies\)](#)
- [Airplane Mode](#)

Interchangeable Lens Digital Camera  
ILCE-7M3 α7III

## Snd to Smrtphn Func: Sending Target (proxy movies)

---

When transferring XAVC S video to a smartphone with [Send to Smartphone], you can set whether to transfer the low-bit-rate proxy movie or the high-bit-rate original movie.

1 MENU →  (Network) → [Snd to Smrtphn Func] → [  Sending Target] → desired setting.

### Menu item details

#### Proxy Only:

Transfers only proxy movies.

#### Original Only:

Transfers only original movies.

#### Proxy & Original:

Transfers both proxy and original movies.

#### Note

- You cannot transfer XAVC S 4K movies or the original data of XAVC S HD movies recorded in [120p]/[100p] to a smartphone. You can only transfer proxy movies.
- While you transfer many images or long movies, we recommend that you supply power to the camera from a wall outlet (wall socket) using the AC Adaptor (supplied).

---

### Related Topic

- [Snd to Smrtphn Func: Send to Smartphone](#)
- [Proxy Recording](#)

Interchangeable Lens Digital Camera  
ILCE-7M3 α7III

## Send to Computer

---

You can transfer images stored in the product to a computer connected to a wireless access point or wireless broadband router and easily make backup copies using this operation. Before starting this operation, install PlayMemories Home on your computer and register the access point on the product.

**1 Start your computer.**

**2 MENU →  (Network) → [Send to Computer] → the desired memory card slot.**

### Note

- Depending on the application settings of your computer, the product will turn off after saving the images to your computer.
- You can transfer images from the product to only one computer at a time.
- If you want to transfer images to another computer, connect the product and the computer via a USB connection and follow the instructions in PlayMemories Home.
- Proxy movies cannot be transferred.

---

### Related Topic

- [Installing PlayMemories Home](#)
- [Wi-Fi Settings: WPS Push](#)
- [Wi-Fi Settings: Access Point Set.](#)

Interchangeable Lens Digital Camera  
ILCE-7M3 α7III

## FTP Transfer Func.

---

You can set up image transferring using an FTP server or transfer images to the FTP server. Basic knowledge of FTP servers is required.

For details, refer to the “FTP Help Guide.”

[http://rd1.sony.net/help/di/ftp/h\\_zz/](http://rd1.sony.net/help/di/ftp/h_zz/)

**1** MENU →  (Network) → [FTP Transfer Func.] → desired setting.

### Menu item details

**FTP Transfer:**

Connects the camera to the network, and transfers images to the FTP server.

**Display FTP Result:**

Displays the results of the most recent FTP transfer.

**Select FTP Server:**

Selects the destination FTP server.

**FTP Server 1/FTP Server 2/FTP Server 3:**

Sets up FTP Servers 1 – 3.

---

### Related Topic

- [Importing root certification to the camera \(Imp Root Certificate\)](#)



Interchangeable Lens Digital Camera  
ILCE-7M3 α7III

## View on TV

You can view images on a network-enabled TV by transferring them from the product without connecting the product and TV with a cable. For some TVs, you may need to perform operations on the TV. For details, refer to the operating instructions supplied with the TV.

1 MENU →  (Network) → [View on TV] → **desired device to be connected.**

2 When you want to play back images using slideshow, press the center of the control wheel.

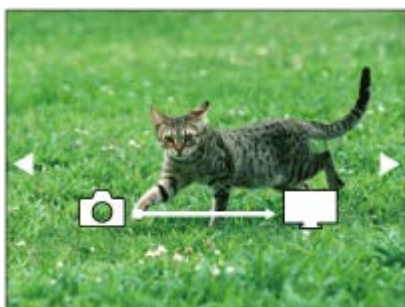

- To display the next/previous image manually, press the right/left sides of the control wheel.
- To change the device to be connected, press the down side of the control wheel, then select [Device list].

## Slideshow settings

You can change the slideshow settings by pressing the down side of the control wheel.

### Playback Selection:

Selects the group of images to be shown.

### Folder View(Still):

Selects from [All] and [All in Folder].

### Date View:

Selects from [All] and [All in Date Rng.].

### Interval:

Selects from [Short] and [Long].

### Effects\*:

Selects from [On] and [Off].

### Playback Image Size:

Selects from [HD] and [4K].

\* The settings are effective only for BRAVIA TV which is compatible with the functions.

## Note

- You can only transfer images that are saved on the memory card in the memory card slot being played back. To change the memory card slot to be played back, select MENU →  (Playback) → [Select PB Media] → the desired slot.
- You can use this function on a TV that supports DLNA renderer.
- You can view images on a Wi-Fi Direct-enabled TV or network-enabled TV (including wired network-enabled TVs).
- If you connect TV and this product and do not use Wi-Fi Direct, you need to register your access point first.
- Displaying the images on the TV may take time.
- Movies cannot be shown on a TV via Wi-Fi. Use an HDMI cable (sold separately).

---

---

**Related Topic**

- [Wi-Fi Settings: WPS Push](#)
- [Wi-Fi Settings: Access Point Set.](#)

4-732-947-11(1) Copyright 2018 Sony Corporation

Interchangeable Lens Digital Camera  
ILCE-7M3 α7III

## Ctrl w/ Smartphone

---

Sets the condition for connecting the camera to a smartphone.

1 MENU →  (Network) → [Ctrl w/ Smartphone] → desired setting.

### Menu item details

#### Ctrl w/ Smartphone:

Sets whether to connect the camera and a smartphone using Wi-Fi. ([On]/[Off])

#### Connection:

Displays the QR code or SSID used to connect the camera to a smartphone.

#### Always Connected:

Sets whether to keep the camera connected to a smartphone. If this item is set to [On], once you connect the camera to a smartphone, it will remain connected to the smartphone at all times. If it is set to [Off], the camera will connect to a smartphone only when the connection procedure is performed.

#### Note

- If [Always Connected] is set to [On], the power consumption will be greater than when it is set to [Off].

---

### Related Topic

- [Controlling the camera using an Android smartphone \(NFC One-touch remote\)](#)
- [Controlling the camera using an Android smartphone \(QR code\)](#)
- [Controlling the camera using an Android smartphone \(SSID\)](#)
- [Controlling the camera using an iPhone or iPad \(QR code\)](#)
- [Controlling the camera using an iPhone or iPad \(SSID\)](#)
- [Snd to Smrtphn Func: Send to Smartphone](#)

Interchangeable Lens Digital Camera  
ILCE-7M3 α7III

## Airplane Mode

---

When you board an airplane, etc., you can temporarily disable all the wireless-related functions including Wi-Fi.

**1** MENU →  (Network) → [Airplane Mode] → **desired setting.**

If you set [Airplane Mode] to [On], an airplane mark will be displayed on the screen.

Interchangeable Lens Digital Camera  
ILCE-7M3 α7III

## Wi-Fi Settings: WPS Push

If your access point has a Wi-Fi Protected Setup (WPS) button, you can register the access point to this product easily.

- 1 MENU →  (Network) → [Wi-Fi Settings] → [WPS Push].
- 2 Push the Wi-Fi Protected Setup (WPS) button on the access point to connect.

### Note

- [WPS Push] works only if the security setting of your access point is set to WPA or WPA2 and your access point supports the Wi-Fi Protected Setup (WPS) button method. If the security setting is set to WEP or your access point does not support the Wi-Fi Protected Setup (WPS) button method, perform [Access Point Set.].
- For details about the available functions and settings of your access point, see the access point operating instructions or contact the administrator of the access point.
- A connection may not be possible or the communication distance may be shorter depending on the surrounding conditions, such as the type of wall material and the presence of obstructions or radio waves between the product and access point. In this case, change the location of the product or move the product closer to the access point.

### Related Topic

- [Wi-Fi Settings: Access Point Set.](#)

## Wi-Fi Settings: Access Point Set.

You can register your access point manually. Before starting the procedure, check the SSID name of the access point, security system, and password. The password may be preset in some devices. For details, see the access point operating instructions, or consult the access point administrator.

1 MENU →  (Network) → [Wi-Fi Settings] → [Access Point Set.].

2 Select the access point you want to register.

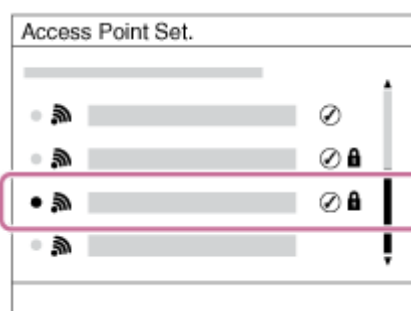

**When the desired access point is displayed on the screen:** Select the desired access point.

**When the desired access point is not displayed on the screen:** Select [Manual Setting] and set the access point.

- If you select [Manual Setting], input the SSID name of the access point, then select the security system.

3 Input the password, and select [OK].

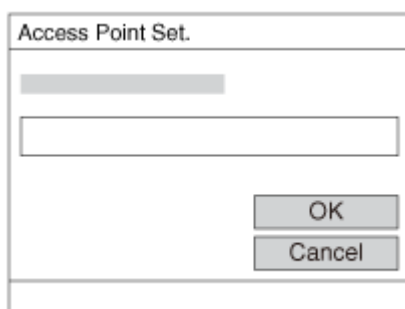

- Access points without the  mark do not require a password.

4 Select [OK].

### Other setting items

Depending on the status or the setting method of your access point, you may want to set more items.

#### WPS PIN:

Displays the PIN code you enter into the connected device.

#### Priority Connection:

Select [On] or [Off].

#### IP Address Setting:

Select [Auto] or [Manual].

**IP Address:**

If you are entering the IP address manually, enter the set address.

**Subnet Mask/Default Gateway/Primary DNS Server/Second DNS Server:**

If you have set [IP Address Setting] to [Manual], enter each address according to your network environment.

**Note**

- To give the registered access point priority in the future, set [Priority Connection] to [On].

---

**Related Topic**

- [Wi-Fi Settings: WPS Push](#)
- [How to use the keyboard](#)

Interchangeable Lens Digital Camera  
ILCE-7M3 α7III

## Wi-Fi Settings: Disp MAC Address

---

Displays the MAC address of this product.

**1** MENU →  (Network) → [Wi-Fi Settings] → [Disp MAC Address].



Interchangeable Lens Digital Camera  
ILCE-7M3 α7III

## Wi-Fi Settings: SSID/PW Reset

---

This product shares the connection information for [Send to Smartphone] and [  Connection] with a device that has permission to connect. If you want to change the device that is permitted to connect, reset the connection information.

**1** MENU →  (Network) → [Wi-Fi Settings] → [SSID/PW Reset] → [OK].

### Note

- If you connect this product to a smartphone after resetting the connection information, you must make the settings for the smartphone again.

---

### Related Topic

- [Snd to Smrtphn Func: Send to Smartphone](#)
- [Ctrl w/ Smartphone](#)

Interchangeable Lens Digital Camera  
ILCE-7M3 α7III

## Bluetooth Settings

---

Controls the settings for connecting the camera to a smartphone via a Bluetooth connection. You need to pair the camera and smartphone before using the location information link function.

If you want to pair the camera and smartphone in order to use the location information link function, refer to “Loc. Info. Link Set..”

1 MENU →  (Network) → [Bluetooth Settings] → desired setting.

### Menu item details

#### Bluetooth Function (On/Off):

Sets whether to activate or not the Bluetooth function of the camera.

#### Pairing:

Displays the screen for pairing the camera and smartphone using PlayMemories Mobile.

#### Disp Device Address:

Displays the BD address of the camera.

---

### Related Topic

- [Loc. Info. Link Set.](#)

Interchangeable Lens Digital Camera  
ILCE-7M3 α7III

## Loc. Info. Link Set.

You can use the application PlayMemories Mobile to obtain location information from a smartphone that is connected with your camera using Bluetooth communication. You can record the obtained location information when shooting images.

### Preparation in advance









To use the location information linking function of the camera, the application PlayMemories Mobile is required. If “Location Information Linkage” is not displayed on the top page of PlayMemories Mobile, you need to perform the following steps beforehand.



1. Install PlayMemories Mobile on your smartphone.
  - You can install PlayMemories Mobile from the application store of your smartphone. If you have already installed the application, update it to the latest version.
2. Transfer a pre-recorded image to your smartphone using the [Send to Smartphone] function of the camera.
  - After you transfer an image recorded using the camera to your smartphone, “Location Information Linkage” will appear on the top page of the application.

### Operating procedure

: Operations performed on the smartphone

: Operations performed on the camera

1. : Confirm that the Bluetooth function of your smartphone is activated.
  - Do not perform the Bluetooth pairing operation on the smartphone setting screen. In steps 2 to 7, the pairing operation is performed using the camera and the application PlayMemories Mobile.
  - If you accidentally perform the pairing operation on the smartphone setting screen in step 1, cancel the pairing and then perform the pairing operation by following Steps 2 through 7 using the camera and the application PlayMemories Mobile.
2. : On the camera, select MENU →  (Network) → [Bluetooth Settings] → [Bluetooth Function] → [On].
3. : On the camera, select MENU →  (Network) → [Bluetooth Settings] → [Pairing].
4. : Launch PlayMemories Mobile on your smartphone and tap “Location Information Linkage.”
  - If “Location Information Linkage” is not displayed, follow the steps in “Preparation in advance” above.
5. : Activate [Location Information Linkage] on the [Location Information Linkage] setting screen of PlayMemories Mobile.
6. : Follow the instructions on the [Location Information Linkage] setting screen of PlayMemories Mobile, and then select your camera from the list.
7. : Select [OK] when a message is displayed on the monitor of the camera.
  - Pairing of the camera and PlayMemories Mobile is complete.

8.  : On the camera, select MENU →  (Network) → [ Loc. Info. Link Set.] → [Location Info. Link] → [On].

-  (obtaining location information icon) will be displayed on the monitor of the camera. Location information obtained by your smartphone using GPS, etc., will be recorded when shooting images.

## Menu item details

### Location Info. Link:

Sets whether to obtain the location information by linking with a smartphone.

### Auto Time Correct.:

Sets whether to automatically correct the date setting of the camera using information from a linked smartphone.

### Auto Area Adjust.:

Sets whether to automatically correct the area setting of the camera using information from a linked smartphone.

## Icons displayed when obtaining the location information

 (Obtaining location information): The camera is obtaining the location information.

 (Location information cannot be obtained): The camera cannot obtain the location information.

 (Bluetooth connection available): Bluetooth connection with the smartphone is established.

 (Bluetooth connection unavailable): Bluetooth connection with the smartphone is not established.

### Hint

- Location information can be linked when PlayMemories Mobile is running on your smartphone even if the smartphone monitor is off. However, if the camera has been turned off for a while, location information may not be linked immediately when you turn the camera back on. In this case, location information will be linked immediately if you open the PlayMemories Mobile screen on the smartphone.
- When PlayMemories Mobile is not operating, such as when the smartphone is restarted, launch PlayMemories Mobile to resume location information linking.
- In the application PlayMemories Home, you can view images on a map by importing images with location information to your computer. For details, refer to Help for PlayMemories Home.
- If the location information linking function does not work properly, see the following notes and perform pairing again.
  - Confirm that the Bluetooth function of your smartphone is activated.
  - Confirm that the camera is not connected with other devices using the Bluetooth function.
  - Confirm that [Airplane Mode] for the camera is set to [Off].
  - Delete the pairing information for the camera registered in PlayMemories Mobile.
  - Execute [Reset Network Set.] of the camera.
- For more detailed video instructions, refer to the following support page.  
<http://www.sony.net/pmm/btg/>

### Note

- When you initialize the camera, the pairing information is also deleted. To perform pairing again, delete the pairing information for the camera registered in PlayMemories Mobile before trying again.
- The location information will not be recorded when it cannot be obtained, such as when the Bluetooth connection is disconnected.
- The camera can be paired with up to 15 Bluetooth devices, but can link the location information with that of only one smartphone. If you want to link the location information with that of another smartphone, turn off the [Location Information Linkage] function of the smartphone that is already linked.
- If the Bluetooth connection is unstable, remove any obstacles, such as people or metal objects from between the camera and the paired smartphone.
- When pairing the camera and your smartphone, be sure to use the [Location Information Linkage] menu on PlayMemories Mobile.

## Supported smartphones

- Android smartphones: Android 5.0 or later and compatible with Bluetooth 4.0 or later\*

- [iPhone/iPad: iPhone 4S or later/iPad 3rd generation or later](#)

\* For the latest information, refer to the support site.

\* For the Bluetooth version, refer to the website for your smartphone.

---

---

## Related Topic

- [PlayMemories Home](#)
- [PlayMemories Mobile](#)
- [Snd to Smrtphn Func: Send to Smartphone](#)
- [Bluetooth Settings](#)

4-732-947-11(1) Copyright 2018 Sony Corporation

Interchangeable Lens Digital Camera  
ILCE-7M3 α7III

## Edit Device Name

---

You can change the device name for the Wi-Fi Direct or Bluetooth connection.

- 1** MENU →  (Network) → [Edit Device Name].
- 2** Select the input box, then input the device name → [OK].

---

### Related Topic

- [Wi-Fi Settings: WPS Push](#)
- [Wi-Fi Settings: Access Point Set.](#)
- [How to use the keyboard](#)

Interchangeable Lens Digital Camera  
ILCE-7M3 α7III

## Importing root certification to the camera (Imp Root Certificate)

---

Imports a root certificate needed to verify a server from a memory card. Use this function for encrypted communications during FTP transfer.

For details, refer to the “FTP Help Guide.”

[http://rd1.sony.net/help/di/ftp/h\\_zz/](http://rd1.sony.net/help/di/ftp/h_zz/)

**1** MENU →  (Network) → [Imp Root Certificate].

Interchangeable Lens Digital Camera  
ILCE-7M3 α7III

## Reset Network Set.

---

Resets all the network settings to default settings.

**1** MENU →  (Network) → [Reset Network Set.] → [Enter].



Interchangeable Lens Digital Camera  
ILCE-7M3 α7III

## Protecting images (Protect)



Protects recorded images against accidental erasure. The  mark is displayed on protected images.

1 MENU →  (Playback) → [Protect] → desired setting.

### Menu item details

#### Multiple Img.:

Applies or cancels the protection of the selected multiple images.

(1) Select the image to be protected, then press the center of the control wheel. The  mark is displayed in the check box. To cancel the selection, press the center again to remove the  mark.

(2) To protect other images, repeat step (1).

(3) MENU → [OK].

#### All in this Folder:

Protects all images in the selected folder.

#### All with this date:

Protects all images in the selected date range.

#### Cancel All in this Folder:

Cancels the protection of all images in the selected folder.

#### Cancel All with this date:

Cancels the protection of all images in the selected date range.

#### All in Cont. Shoot Grp:

Protects all the images in the selected continuous shooting group.

#### Cancel All in Cnt Sht Grp:

Cancels the protection of all the images in the selected continuous shooting group.

#### Hint

- The [Protect] function is assigned to the C3 button in the default settings.
- If you select a continuous shooting group in [Multiple Img.], all the images in the group will be protected. To select and protect particular images within the group, execute [Multiple Img.] while displaying the images within the group.

#### Note

- The menu items that can be selected vary according to the [View Mode] setting and the selected content.

Interchangeable Lens Digital Camera  
ILCE-7M3 α7III

## Rotating an image (Rotate)

---

Rotates a recorded still image counter-clockwise.

**1** Display the image to be rotated, then select MENU →  (Playback) → [Rotate].

**2** Press the center of the control wheel.

The image is rotated counter-clockwise. The image rotates as you press the center.

If you rotate the image once, the image remains rotated even after the product is turned off.

### Note

- You cannot rotate the movies.
- You may not be able to rotate images shot using other products.
- When viewing rotated images on a computer, the images may be displayed in their original orientation depending on the software.

Interchangeable Lens Digital Camera  
ILCE-7M3 α7III

## Deleting multiple selected images (Delete)



You can delete multiple selected images. Once you have deleted an image, you cannot restore it. Confirm the image to be deleted beforehand.

1 MENU →  (Playback) → [Delete] → desired setting.

### Menu item details

#### Multiple Img.:

Deletes the selected images.

(1) Select the images to be deleted, then press the center of the control wheel. The  mark is displayed in the check box. To cancel the selection, press the center again to remove the  mark.

(2) To delete other images, repeat step (1).

(3) MENU → [OK].

#### All in this Folder:

Deletes all images in the selected folder.

#### All with this date:

Deletes all images in the selected date range.

#### All Other Than This Img.:

Deletes all images in the continuous shooting group except the selection.

#### All in Cont. Shoot Grp:

Deletes all images in the selected continuous shooting group.

### Hint

- Perform [Format] to delete all images, including protected images.
- To display the desired folder or date, select the desired folder or date during playback by performing the following procedure:  
 (Image Index) button → select the bar on the left using the control wheel → select the desired folder or date using the top/bottom sides of the control wheel.
- If you select a continuous shooting group in [Multiple Img.], all the images in the group will be deleted. To select and delete particular images within the group, execute [Multiple Img.] while displaying the images within the group.

### Note

- The protected images cannot be deleted.
- The menu items that can be selected vary according to the [View Mode] setting and the selected content.

### Related Topic

- [Deleting a displayed image](#)
- [Format](#)

Interchangeable Lens Digital Camera  
ILCE-7M3 α7III

## Rating

You can assign ratings to recorded images on a scale from ★ to ★★★ to make it easier to find images. Combining this function with [Image Jump Setting] allows you to find a desired image quickly.

- 1 MENU →  (Playback) → [Rating].**  
The image rating selection screen will appear.
- 2 Press the left/right sides of the control wheel to display an image to which you want to assign a rating, and then press the center.**
- 3 Select the number of ★ (Rating) by pressing the left/right sides of the control wheel, and then press the center.**
- 4 Press the MENU button to exit the rating setting screen.**

### Hint

- You can also assign ratings when playing back images by using the custom key. Assign [Rating] to the desired key using [ Custom Key] beforehand, and then press the custom key while playing back an image to which you want to assign a rating. The number of ★ (Rating) changes each time you press the custom key.

### Note

- You can assign ratings to still images only.

### Related Topic

- [Custom Key \(still image/movie/playback\)](#)
- [Rating Set\(Cust Key\)](#)
- [Setting the method for jumping between images \(Image Jump Setting\)](#)

Interchangeable Lens Digital Camera  
ILCE-7M3 α7III

## Rating Set(Cust Key)

---

Sets the available number of ★ when rating images with the key to which you have assigned [Rating] using [  Custom Key].

**1** MENU →  (Playback) → [Rating Set(Cust Key)].

**2** Add a ✓ mark to the number of ★ that you want to activate.

You can select the checked number when setting [Rating] using the custom key.

---

### Related Topic

- [Rating](#)
- [Custom Key \(still image/movie/playback\)](#)

Interchangeable Lens Digital Camera  
ILCE-7M3 α7III

## Specifying images to be printed (Specify Printing)



You can specify in advance on the memory card which still images you want to print out later. The **DPOF** (print order) icon will appear on the specified images. DPOF refers to “Digital Print Order Format.” DPOF setting will be retained after the image is printed. We recommend that you cancel this setting after printing.

1 MENU →  (Playback) → [Specify Printing] → desired setting.

### Menu item details

#### Multiple Img.:

Selects images to order printing.

(1) Select an image and press the center of the control wheel. The  mark is displayed in the check box. To cancel the selection, press the center again and delete the  mark.

(2) Repeat step (1) to print other images. To select all the images from a certain date or in a certain folder, select the check box for the date or folder.

(3) MENU → [OK].

#### Cancel All:

Clears all DPOF marks.

#### Print Setting:

Sets whether to print the date on images registered with DPOF marks.

- The position or size of the date (inside or outside of the image) may differ depending on the printer.

#### Note

- You cannot add the DPOF mark to the following files:
  - RAW images
- The number of copies cannot be specified.
- Some printers do not support the date print function.

Interchangeable Lens Digital Camera  
ILCE-7M3 α7III

## Copying images from one memory card to another (Copy)

You can copy images from a memory card in a slot that is selected using [Select PB Media] to a memory card in another slot.

### 1 MENU → (Playback) → [Copy].

All of the contents with a date or in a folder currently being played back will be copied to a memory card in another slot.

#### Hint

- You can select the type of images to be displayed by selecting MENU →  (Playback) → [View Mode].

#### Note

- If images in a continuous shooting group are copied, the copied images will not be displayed as a group on the destination memory card.
- If protected images are copied, the protection will be canceled on the destination memory card.
- It may take a long time when many images are to be copied. Use a sufficiently charged battery pack.
- XAVC S movies can only be copied to a memory card that supports XAVC S movies. A message will be displayed on the monitor of the camera when images cannot be copied.

#### Related Topic



- [Selecting which memory card to play back \(Select PB Media\)](#)
- [Switching between still images and movies \(View Mode\)](#)

Interchangeable Lens Digital Camera  
ILCE-7M3 α7III

## Photo Capture

---

Captures a chosen scene in a movie to save as a still image. First shoot a movie, then pause the movie during playback to capture decisive moments that tend to be missed when shooting still images, and save them as still images.

- 1 **Display the movie that you want to capture as a still image.**
  - 2 **MENU →  (Playback) → [Photo Capture].**
  - 3 **Play back the movie and pause it.**
  - 4 **Find the desired scene using forward slow playback, reverse slow playback, displays the next frame, and displays the previous frame, and then stop the movie.**
  - 5 **Press  (Photo Capture) to capture the chosen scene.**  
The scene is saved as a still image.
- 

### Related Topic

- [Shooting movies](#)
- [Playing back movies](#)





Interchangeable Lens Digital Camera  
ILCE-7M3 α7III

## Enlarging an image being played back (Enlarge Image)

Enlarges the image being played back. Use this function to check the focus of the image, etc.

- 1 Display the image you want to enlarge, and then press the  button.**
  - Turn the control wheel to adjust the zoom scale. By rotating the front/rear dial, you can switch to the previous or next image while keeping the same zoom scale.
  - The view will zoom in on the part of the image where the camera focused during shooting. If the focus location information cannot be obtained, the camera will zoom in on the center of the image.
- 2 Select the portion you want to enlarge by pressing the top/bottom/right/left sides of the control wheel.**
- 3 Press the MENU button or the center of the control wheel to exit the playback zoom.**

### Hint

- You can also enlarge an image being played back using MENU.
- You can change the initial magnification and initial position of enlarged images by selecting MENU →  (Playback) → [ Enlarge Init. Mag.] or [ Enlarge Initial Pos.].
- You can also enlarge an image by double-tapping the monitor. In addition, you can drag and move the magnified position on the monitor. Set [Touch Operation] to [On] beforehand.

### Note

- You cannot enlarge movies.

### Related Topic

- [Touch Operation](#)
- [Enlarge Init. Mag.](#)
- [Enlarge Initial Pos.](#)

Interchangeable Lens Digital Camera  
ILCE-7M3 α7III

## Enlarge Init. Mag.

---

Sets the initial magnification scale when playing back enlarged images.

1 MENU →  (Playback) → [ Enlarge Init. Mag.] → **desired setting.**

### Menu item details

#### Standard. Mag.:

Displays an image with the standard magnification.

#### Previous Mag.:

Displays an image with the previous magnification. The previous magnification is stored even after exiting the playback zoom mode.

---

### Related Topic

- [Enlarging an image being played back \(Enlarge Image\)](#)
- [Enlarge Initial Pos.](#)

Interchangeable Lens Digital Camera  
ILCE-7M3 α7III

## Enlarge Initial Pos.

---

Sets the initial position when enlarging an image in playback.

**1** MENU →  (Playback) → [ Enlarge Initial Pos.] → desired setting.

### Menu item details

**Focused Position:**

Enlarges the image from the point of focus during shooting.

**Center:**

Enlarges the image from the center of the screen.

---

### Related Topic

- [Enlarging an image being played back \(Enlarge Image\)](#)
- [Enlarge Init. Mag.](#)

Interchangeable Lens Digital Camera  
ILCE-7M3 α7III

## Playing back images using slideshow (Slide Show)

---

Automatically plays back images continuously.

1 MENU →  (Playback) → [Slide Show] → desired setting.

2 Select [Enter].

### Menu item details

#### Repeat:

Select [On], in which images are played back in a continuous loop, or [Off], in which the product exits the slideshow when all the images are played back once.

#### Interval:

Select the display interval for images from among [1 Sec], [3 Sec], [5 Sec], [10 Sec] or [30 Sec].

### To quit the slideshow in the middle of playback

Press the MENU button to quit the slideshow. You cannot pause the slideshow.

#### Hint

- During playback, you can display the next/previous image by pressing the right/left side of the control wheel.
- You can activate a slideshow only when [View Mode] is set to [Date View] or [Folder View(Still)].

Interchangeable Lens Digital Camera  
ILCE-7M3 α7III

## Selecting which memory card to play back (Select PB Media)

---

Selects the memory card slot to be played back.

**1** MENU →  (Playback) → [Select PB Media] → desired slot.

### Menu item details

#### Slot 1:

Selects the slot 1.

#### Slot 2:

Selects the slot 2.

#### Note

- No image is played back when no memory card is inserted in the selected slot. Select a slot into which a memory card has been inserted.
- When you select [Date View] in [View Mode], the camera only plays back images from a memory card selected using [Select PB Media].

---

### Related Topic

- [Switching between still images and movies \(View Mode\)](#)
- [Rec. Media Settings: Prioritize Rec. Media](#)

Interchangeable Lens Digital Camera  
ILCE-7M3 α7III

## Switching between still images and movies (View Mode)

---

Sets the View Mode (image display method).

1 MENU →  (Playback) → [View Mode] → desired setting.

### Menu item details

 **Date View:**

Displays the images by date.

 **Folder View(Still):**

Displays only still images.

 **AVCHD AVCHD View:**

Displays only AVCHD-format movies.

 **XAVC S HD View:**

Displays only XAVC S HD-format movies.

 **XAVC S 4K View:**

Displays only XAVC S 4K-format movies.

Interchangeable Lens Digital Camera  
ILCE-7M3 α7III

## Playing back images on the image index screen (Image Index)

---

You can display multiple images at the same time in playback mode.

- 1 Press the  (Image Index) button while the image is being played back.
- 2 Select the image by pressing the top/bottom/right/left sides of the control wheel or turning the control wheel.

### To change the number of images to be displayed

MENU →  (Playback) → [Image Index] → desired setting.

#### Menu item details

9 Images/25 Images

### To return to single-image playback

Select the desired image and press the center of the control wheel.

### To display a desired image quickly

Select the bar on the left of the image index screen using the control wheel, then press the top/bottom sides of the control wheel. While the bar is being selected, you can display the calendar screen or folder selection screen by pressing the center. In addition, you can switch View Mode by selecting an icon.

---

#### Related Topic

- [Switching between still images and movies \(View Mode\)](#)

Interchangeable Lens Digital Camera  
ILCE-7M3 α7III

## Disp Cont Shoot Grp

Sets whether to display continuously shot images as a group.

1 MENU →  (Playback) → [Disp Cont Shoot Grp] → desired setting.

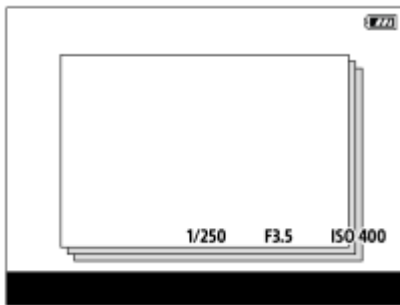

### Menu item details

#### On:

Displays continuously shot images as a group.

#### Off:

Does not display continuously shot images as a group.

#### Hint

- Images shot with [Drive Mode] set to [Cont. Shooting] are grouped. One sequence of images shot continuously by holding down the shutter button during continuous shooting becomes one group.
- On the image index screen,  is displayed over the continuous shooting group.

#### Note

- Images can be grouped and displayed only when [View Mode] is set to [Date View]. When it is not set to [Date View], images cannot be grouped and displayed, even if [Disp Cont Shoot Grp] is set to [On].
- If you delete the continuous shooting group, all the images in the group will be deleted.

### Related Topic

- [Cont. Shooting](#)



Interchangeable Lens Digital Camera  
ILCE-7M3 α7III

## Rotating recorded images automatically (Display Rotation)

---

Selects the orientation when playing back recorded images.

1 MENU →  (Playback) → [Display Rotation] → desired setting.

### Menu item details

#### Auto:

When you rotate the camera, the displayed image rotates automatically by detecting the orientation of the camera.

#### Manual:

Images shot vertically are displayed vertically. If you have set the image orientation using the [Rotate] function, the image will be displayed accordingly.

#### Off:

Images are always displayed horizontally.

---

### Related Topic

- [Rotating an image \(Rotate\)](#)

Interchangeable Lens Digital Camera  
ILCE-7M3 α7III

## Setting the method for jumping between images (Image Jump Setting)

---

Sets which dial and method to use for jumping between images during playback. You can quickly find protected images or images set with a particular rating.

1 MENU →  (Playback) → [Image Jump Setting] → desired setting.

### Menu item details

#### Select Dial:

Selects the dial to use for jumping between images.

#### Image Jump Method:

Sets the type of images to be played back with Image Jump.

#### Note

- [Image Jump Setting] is available only when [View Mode] is set to [Date View]. If [View Mode] is not set to [Date View], the camera will always play back every image without jumping when you use the dial selected with [Select Dial].
- When you use the Image Jump function, movie files are always skipped.

---

### Related Topic

- [Rating](#)
- [Protecting images \(Protect\)](#)

Interchangeable Lens Digital Camera  
ILCE-7M3 α7III

## Monitor Brightness

---

Adjust the brightness of the screen.

**1** MENU →  (Setup) → [Monitor Brightness] → desired setting.

### Menu item details

**Manual:**

Adjusts the brightness within the range of -2 to +2.

**Sunny Weather:**

Sets the brightness appropriately for shooting outdoors.

**Note**

- The [Sunny Weather] setting is too bright for shooting indoors. Set [Monitor Brightness] to [Manual] for indoor shooting.

Interchangeable Lens Digital Camera  
ILCE-7M3 α7III

## Viewfinder Bright.

---

When using an electronic viewfinder, this product adjusts the brightness of the electronic viewfinder according to the surrounding environment.

**1** MENU →  (Setup) → [Viewfinder Bright.] → desired setting.

### Menu item details

**Auto:**

Adjusts the brightness automatically.

**Manual:**

Selects the brightness of the electronic viewfinder within the range of -2 to +2.

Interchangeable Lens Digital Camera  
ILCE-7M3 α7III

## Finder Color Temp.

---

Adjusts the color temperature of the electronic viewfinder.

**1** MENU →  (Setup) → [Finder Color Temp.] → desired setting.

### Menu item details

#### **-2 to +2:**

When you select “-,” the viewfinder screen changes to a warmer color, and when you select “+,” it changes to a colder color.

Interchangeable Lens Digital Camera  
ILCE-7M3 α7III

## Gamma Disp. Assist

Movies with S-Log gamma are assumed to be processed after shooting in order to make use of the wide dynamic range. Movies with the HLG gamma are assumed to be displayed on HDR-compatible monitors. They are therefore displayed in low contrast during shooting and may be difficult to monitor, using [Gamma Disp. Assist], contrast equivalent to that of normal gamma can be reproduced. In addition, [Gamma Disp. Assist] can also be applied when playing back movies on the camera's monitor/viewfinder.

- 1 **MENU** →  (Setup) → **[Gamma Disp. Assist]**.
- 2 **Select the desired setting using the top/bottom sides of the control wheel.**

### Menu item details

Assist  
OFF **Off:**

Does not apply [Gamma Disp. Assist].

Assist  
AUTO **Auto:**

Displays movies with an [S-Log2→709(800%)] effect when the gamma set in [Picture Profile] is [S-Log2], and with an [S-Log3→709(800%)] effect when the gamma is set to [S-Log3]. Displays movies with an [HLG(BT.2020)] effect when the gamma set in [Picture Profile] is [HLG], [HLG1], [HLG2] or [HLG3], and [Color Mode] is set to [BT.2020].

Displays movies with an [HLG(709)] effect when the gamma set in [Picture Profile] is [HLG], [HLG1], [HLG2] or [HLG3], and [Color Mode] is set to [709].

Assist  
S-Log2 **S-Log2→709(800%):**

Displays movies with an S-Log2 gamma reproducing contrast equivalent to ITU709 (800%).

Assist  
S-Log3 **S-Log3→709(800%):**

Displays movies with an S-Log3 gamma reproducing contrast equivalent to ITU709 (800%).

Assist  
HLG 2020 **HLG(BT.2020):**

Displays movies after adjusting the image quality of the monitor or viewfinder to a quality that is almost the same as when movies are displayed on an [HLG(BT.2020)] compatible monitor.

Assist  
HLG 709 **HLG(709):**

Displays movies after adjusting the image quality of the monitor or viewfinder to a quality that is almost the same as when movies are displayed on an [HLG(709)] compatible monitor.

#### Note

- Movies in the XAVC S 4K or XAVC S HD format with the [HLG], [HLG1], [HLG2], or [HLG3] gamma are displayed with an [HLG(BT.2020)] effect or [HLG(709)] effect depending on the movie's gamma value and color mode. In other situations, movies are displayed according to the gamma setting and color mode setting in [Picture Profile].
- [Gamma Disp. Assist] is not applied to movies when displayed on a TV or monitor connected to the camera.

### Related Topic

- [Picture Profile](#)

Interchangeable Lens Digital Camera  
ILCE-7M3 α7III

## Volume Settings

---

Sets the sound volume for movie playback.

**1** MENU →  (Setup) → [Volume Settings] → desired setting.

### Adjusting the volume during playback

Press the bottom side of the control wheel while playing back movies to display the operation panel, then adjust the volume. You can adjust the volume while listening to the actual sound.

Interchangeable Lens Digital Camera  
ILCE-7M3 α7III

## Delete confirm.

---

You can set whether [Delete] or [Cancel] is selected as a default on the delete confirmation screen.

**1** MENU →  (Setup) → [Delete confirm.] → desired setting.

### Menu item details

**"Delete" first:**

[Delete] is selected as the default setting.

**"Cancel" first:**

[Cancel] is selected as the default setting.



Interchangeable Lens Digital Camera  
ILCE-7M3 α7III

## Display Quality

---

You can change the display quality.

**1** MENU →  (Setup) → [Display Quality] → desired setting.

### Menu item details

**High:**

Displays in high quality.

**Standard:**

Displays in standard quality.

**Note**

- When [High] is set, battery consumption will be higher than when [Standard] is set.
- When the temperature of the camera rises, the setting may become locked to [Standard].

Interchangeable Lens Digital Camera  
ILCE-7M3 α7III

## Pwr Save Start Time

---

Sets time intervals to automatically switch to power save mode when you are not performing operations to prevent wearing down the battery pack. To return to shooting mode, perform an operation such as pressing the shutter button halfway down.

1 MENU →  (Setup) → [Pwr Save Start Time] → desired setting.

### Menu item details

30 Min/5 Min/2 Min/1 Min/10 Sec

#### Note

- Turn off the product when you do not use it for a long time.
- The power save function is not activated when power is being supplied via USB, when playing back slideshows, when recording movies, or when connected to a computer or TV.

Interchangeable Lens Digital Camera  
ILCE-7M3 α7III

## Auto Pwr OFF Temp.

Sets the temperature of the camera at which the camera turns off automatically during shooting. When it is set to [High], you can continue shooting even when the temperature of the camera gets hotter than normal.

1 MENU →  (Setup) → [Auto Pwr OFF Temp.] → desired setting.

### Menu item details

#### Standard:

Sets the standard temperature for the camera to turn off.

#### High:

Sets the temperature at which the camera turns off to higher than [Standard].

#### Notes when [Auto Pwr OFF Temp.] is set to [High]

- Do not shoot while holding the camera in your hand. Use a tripod.
- Using the camera while holding it in your hand for a long period of time may cause low-temperature burns.

### Continuous recording time for movies when [Auto Pwr OFF Temp.] is set to [High]

The duration of time available for continuous movie recording is as follows when the camera starts recording with the default settings after the power has been turned off for a while. The following values indicate the continuous time from when the camera starts recording until the camera stops recording.

#### Ambient temperature: 20°C (68°F)

Continuous recording time for movies (HD): Approx. 29 minutes

Continuous recording time for movies (4K): Approx. 29 minutes

#### Ambient temperature: 30°C (86°F)

Continuous recording time for movies (HD): Approx. 29 minutes

Continuous recording time for movies (4K): Approx. 29 minutes

#### Ambient temperature: 40°C (104°F)

Continuous recording time for movies (HD): Approx. 29 minutes

Continuous recording time for movies (4K): Approx. 29 minutes

HD: XAVC S HD (60p 50M/50p 50M, when the camera is not connected via Wi-Fi)

4K: XAVC S 4K (24p 60M/25p 60M, when the camera is not connected via Wi-Fi)

#### Note

- Even if [Auto Pwr OFF Temp.] is set to [High], depending on the conditions or the temperature of the camera, the recordable time for movies may not change.

### Related Topic

- [Recordable movie times](#)



Interchangeable Lens Digital Camera  
ILCE-7M3 α7III

## NTSC/PAL Selector

Plays back movies recorded with the product on a NTSC/PAL system TV.

1 MENU →  (Setup) → [NTSC/PAL Selector] → [Enter]

### Note

- If you insert a memory card that has previously been formatted with a different video system, a message telling you that you must reformat the card will appear.  
If you want to record using another system, re-format the memory card or use another memory card.
- When you perform [NTSC/PAL Selector], and the setting is changed from the default one, a message "Running on NTSC." or "Running on PAL." will appear on the start-up screen.
- When [NTSC/PAL Selector] is set to PAL, the viewfinder or monitor of the camera or the screen of an HDMI-connected device may black out for an instant in the following situations. This is not a malfunction.
  - When you start or stop recording movies while the shooting mode is set to a mode other than  (Movie) or **S&Q**.
  - When you change the shooting mode from  (Movie) or **S&Q** to another mode.
  - When you play back a movie for the first time after switching to the playback mode.

## Cleaning Mode

If dust or debris gets inside the camera and adheres to the surface of the image sensor (the part that converts the light to an electric signal), it may appear as dark spots on the image, depending on the shooting environment. If this happens, follow the steps below to clean the image sensor.

- 1 **Confirm that the battery has been charged sufficiently.**
- 2 **MENU** →  (**Setup**) → **[Cleaning Mode]** → **[Enter]**.  
The image sensor vibrates a little to shake off the dust.
- 3 **Turn off the product following the instructions on the screen.**
- 4 **Detach the lens.**
- 5 **Use the blower to clean the image sensor surface and the surrounding area.**



- 6 **Attach the lens.**

### Hint

- For how to check the amount of dust on the image sensor, and for further details on cleaning methods, please refer to the following URL.  
<http://support.d-imaging.sony.co.jp/www/support/ilc/sensor/index.php>

### Note

- Clean the image sensor quickly.
- A blower is not supplied with this product. Use a commercially available blower.
- Make sure that the remaining battery level is  (3 remaining battery icons) or more, before performing the cleaning. The use of AC adaptor (supplied) is recommended.
- Do not use a spray type blower as it may scatter water droplets inside the camera body.
- Do not put the tip of a blower into the cavity beyond the lens mount area, so that the tip of the blower does not touch the image sensor.

- Hold the camera slightly face downward so that the dust falls out.
- Do not subject the product to any shock during cleaning.
- When cleaning the image sensor with a blower, do not blow too hard. If you blow the sensor too hard, the inside of the product may be damaged.
- If the dust remains even after you cleaned the product as described, consult the service facility.

---

### Related Topic

- [Troubleshooting](#)

4-732-947-11(1) Copyright 2018 Sony Corporation

Interchangeable Lens Digital Camera  
ILCE-7M3 α7III

## Touch Operation

---

Sets whether or not to activate touch operations on the monitor.

**1** MENU →  (Setup) → [Touch Operation] → desired setting.

### Menu item details

**On:**

Activates the touch operation.

**Off:**

Deactivates the touch operation.

---

### Related Topic

- [Touch Focus](#)
- [Touch Pad Settings](#)
- [Touch Panel/Pad](#)

Interchangeable Lens Digital Camera  
ILCE-7M3 α7III

## Touch Panel/Pad

---

Touch operations when shooting with the monitor are referred to as "touch panel operations," and touch operations when shooting with the viewfinder are referred to as "touch pad operations." You can select whether to activate touch panel operations or touch pad operations.

1 MENU →  (Setup) → [Touch Panel/Pad] → desired setting.

### Menu item details

**Touch Panel+Pad:**

Activates both the touch panel operations when shooting with the monitor and touch pad operations when shooting with the viewfinder.

**Touch Panel Only:**

Activates only the touch panel operations when shooting with the monitor.

**Touch Pad Only:**

Activates only the touch pad operations when shooting with the viewfinder.

---

### Related Topic

- [Touch Operation](#)



Interchangeable Lens Digital Camera  
ILCE-7M3 α7III

## Touch Pad Settings

You can adjust settings related to touch pad operations during viewfinder shooting.

1 MENU →  (Setup) → [Touch Pad Settings] → desired setting.

### Menu item details

#### Operation in V Orient.:

Sets whether to enable touch pad operations during vertically oriented viewfinder shooting. You can prevent erroneous operations during vertically oriented shooting caused by your nose, etc. touching the monitor.

#### Touch Pos. Mode:

Sets whether to move the focusing frame to the position touched on the screen ([Absolute Position]), or move the focusing frame to the desired position based on the direction of dragging and the amount of movement ([Relative Position]).

#### Operation Area:

Sets the area to be used for touch pad operations. Restricting the operational area can prevent erroneous operations caused by your nose, etc. touching the monitor.

### About Touch Positioning Mode

Selecting [Absolute Position] lets you move the focusing frame to a distant position more quickly because you can directly specify the position of the focusing frame with touch operations.

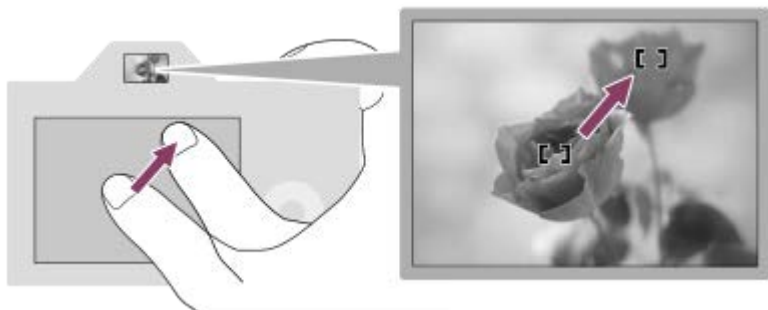

Selecting [Relative Position] lets you operate the touch pad from wherever is easiest, without having to move your finger over a wide area.

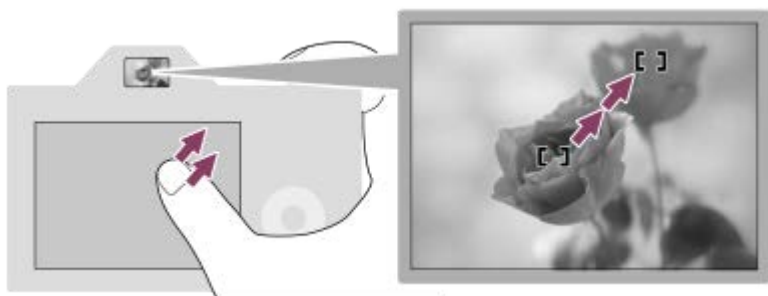

#### Hint

- In touch pad operations when [Touch Pos. Mode] is set to [Absolute Position], the area set in [Operation Area] is treated as the entire screen.

---

---

## Related Topic

- [Touch Operation](#)

4-732-947-11(1) Copyright 2018 Sony Corporation

Interchangeable Lens Digital Camera  
ILCE-7M3 α7III

## Demo Mode

The [Demo Mode] function displays the movies recorded on the memory card automatically (demonstration), when the camera has not been operated for a certain time. Normally select [Off].

1 MENU →  (Setup) → [Demo Mode] → desired setting.

### Menu item details

#### On:

The movie playback demonstration starts automatically if the product is not operated for about one minute. Only protected AVCHD movies can be played back.

Set the view mode to [AVCHD View], and protect the movie file with the oldest recorded date and time.

#### Off:

Does not show the demonstration.

#### Note

- You can set this item only when the product is powered by the AC Adaptor (supplied).
- When there is no protected AVCHD movies on the memory card, you cannot select [On].
- [Demo Mode] always displays movies on the memory card in memory card slot 1.

Interchangeable Lens Digital Camera  
ILCE-7M3 α7III

## TC/UB Settings

The time code (TC) and the user bit (UB) information can be recorded as data attached to movies.

- 1 MENU →  (Setup) → [TC/UB Settings] → setting value you want to change.

### Menu item details

#### TC/UB Disp. Setting:

Sets the display for the counter, time code, and user bit.

#### TC Preset:

Sets the time code.

#### UB Preset:

Sets the user bit.

#### TC Format:

Sets the recording method for the time code. (Only when [NTSC/PAL Selector] is set to NTSC.)

#### TC Run:

Sets the count up format for the time code.

#### TC Make:

Sets the recording format for the time code on the recording medium.



#### UB Time Rec:

Sets whether or not to record the time as a user bit.

### How to set the time code (TC Preset)

1. MENU →  (Setup) → [TC/UB Settings] → [TC Preset].
2. Turn the control wheel and select the first two digits.
  - The time code can be set between the following range.
    - When [60i] is selected: 00:00:00:00 to 23:59:59:29
    - \* When [24p] is selected, you can select the last two digits of the time code in multiples of four from 0 to 23 frames.
    - When [50i] is selected: 00:00:00:00 to 23:59:59:24
3. Set the other digits following the same procedure as in step 2, then press in the center of the control wheel.



### How to reset the time code

1. MENU →  (Setup) → [TC/UB Settings] → [TC Preset].
  2. Press the  (Delete) button to reset the time code (00:00:00:00).
- You can also reset the time code (00:00:00:00) using the RMT-VP1K remote commander (sold separately).

### How to set the user bit (UB Preset)

1. MENU →  (Setup) → [TC/UB Settings] → [UB Preset].
2. Turn the control wheel and select the first two digits.
3. Set the other digits following the same procedure as in step 2, then press in the center of the control wheel.

### How to reset the user bit

1. MENU →  (Setup) → [TC/UB Settings] → [UB Preset].
2. Press the  (Delete) button to reset the user bit (00 00 00 00).

### How to select the recording method for the time code (TC Format<sup>\*1</sup>)

1. MENU →  (Setup) → [TC/UB Settings] → [TC Format].

#### **DF:**

Records the time code in Drop Frame<sup>\*2</sup> format.

#### **NDF:**

Records the time code in Non-Drop Frame format.

\*1 Only when [NTSC/PAL Selector] is set to NTSC.

\*2 The time code is based on 30 frames per second. However, a gap between the actual time and the time code will occur during extended periods of recording as the frame frequency of the NTSC image signal is approximately 29.97 frames per second. Drop frame corrects this gap to make the time code and actual time equal. In drop frame, the first 2 frame numbers are removed every minute except for every tenth minute. The time code without this correction is called non-drop frame.

- The setting is fixed to [NDF] when recording in 4K/24p or 1080/24p.

### **How to select the count up format for the time code (TC Run)**

1. MENU →  (Setup) → [TC/UB Settings] → [TC Run].

#### **Rec Run:**

Sets the stepping mode for the time code to advance only while recording. The time code is recorded sequentially from the last time code of the previous recording.

#### **Free Run:**

Sets the stepping mode for the time code to advance anytime, regardless of the camera operation.

- The time code may not be recorded sequentially in the following situations even when the time code advances in [Rec Run] mode.
  - When the recording format is changed.
  - When the recording medium is removed.







### **How to select how the time code is recorded (TC Make)**

1. MENU →  (Setup) → [TC/UB Settings] → [TC Make].

#### **Preset:**

Records the newly set time code on the recording medium.

#### **Regenerate:**

Reads the last time code for the previous recording from the recording medium and records the new time code consecutively from the last time code. The time code is read from the memory card in the slot 1 when [Recording Mode] under [Rec. Media Settings] is set to [Simult. (  )] or [Simult. (  /  )]. The time code is read from the memory card to which the movies will be recorded when [Recording Mode] is set to [Standard], [Simult. (  )], [Sort(RAW/JPEG)], [Sort(JPEG/RAW)] or [Sort(  /  )]. The time code advances in [Rec Run] mode regardless of the [TC Run] setting.

Interchangeable Lens Digital Camera  
ILCE-7M3 α7III

## Remote Ctrl

---

You can operate this product and shoot images using the SHUTTER button, 2SEC button (2 second delay shutter), and START/STOP button (or Movie button (RMT-DSLR2 only)) on the Wireless Remote Commander RMT-DSLR1 (sold separately) and RMT-DSLR2 (sold separately). Refer also to the operating instructions for the Wireless Remote Commander.

1 MENU →  (Setup) → [Remote Ctrl] → desired setting.

### Menu item details

**On:**

Allows remote commander operation.

**Off:**

Does not allow remote commander operation.

**Note**

- The lens or lens hood may block the remote sensor that receive the signals. Use the remote commander in the position from which the signal can reach the product.
- When [Remote Ctrl] is set to [On], the product does not switch to power save mode. Set [Off] after using a remote commander.

Interchangeable Lens Digital Camera  
ILCE-7M3 α7III

## HDMI Settings: HDMI Resolution

When you connect the product to a High Definition (HD) TV with HDMI terminals using an HDMI cable (sold separately), you can select HDMI Resolution to output images to the TV.

1 MENU →  (Setup) → [HDMI Settings] → [HDMI Resolution] → desired setting.

### Menu item details

**Auto:**

The product automatically recognizes an HD TV and sets the output resolution.

**2160p/1080p:**

Outputs signals in 2160p/1080p.

**1080p:**

Outputs signals in HD picture quality (1080p).

**1080i:**

Outputs signals in HD picture quality (1080i).



**Note**

- If the images are not displayed properly using the [Auto] setting, select either [1080i], [1080p] or [2160p/1080p], based on which TV is to be connected.

Interchangeable Lens Digital Camera  
ILCE-7M3 α7III

## HDMI Settings: 24p/60p Output (movie) (Only for 1080 60i compatible models)

You can set 1080/24p or 1080/60p as the HDMI output format when [ Record Setting] is set to [24p 50M], [24p 60M] or [24p 100M].

- 1 MENU →  (Setup) → [HDMI Settings] → [HDMI Resolution] → [1080p].
- 2 MENU →  (Setup) → [HDMI Settings] → [ 24p/60p Output] → desired setting.

### Menu item details

#### 60p:

Movies are output as 60p.

#### 24p:

Movies are output as 24p.

#### Note

- Steps 1 and 2 can be set in either order.

### Related Topic

- [Record Setting \(movie\)](#)



Interchangeable Lens Digital Camera  
ILCE-7M3 α7III

## HDMI Settings: HDMI Info. Display

Selects whether to display the shooting information when this product and the TV are connected using an HDMI cable (sold separately).

1 MENU →  (Setup) → [HDMI Settings] → [HDMI Info. Display] → desired setting.

### Menu item details

#### On:

Displays the shooting information on the TV.

The recorded image and the shooting information are displayed on the TV, while nothing is displayed on the camera's monitor.

#### Off:

Does not display the shooting information on the TV.

Only the recorded image is displayed on the TV, while the recorded image and the shooting information are displayed on the camera's monitor.

#### Note

- When this product is connected to a 4K-compatible TV, [Off] is selected automatically.
- If you set [ File Format] to [XAVC S 4K] and shoot movies while the camera is connected to an HDMI device, images will not be displayed on the monitor.

Interchangeable Lens Digital Camera  
ILCE-7M3 α7III

## HDMI Settings: TC Output (movie)

Sets whether or not to layer the TC (time code) information on the output signal via the HDMI terminal when outputting the signal to other professional-use devices.

This function layers the time code information on the HDMI output signal. The product sends the time code information as digital data, not as an image displayed on the screen. The connected device can then refer to the digital data to recognize the time data.

1 MENU →  (Setup) → [HDMI Settings] → [ TC Output] → desired setting.

### Menu item details



**On:**

Time code is output to other devices.

**Off:**

Time code is not output to other devices.

**Note**

- When [ TC Output] is set to [On], the image may not be output properly to the TV or recording device. In such cases, set [ TC Output] to [Off].

Interchangeable Lens Digital Camera  
ILCE-7M3 α7III

## HDMI Settings: REC Control (movie)

If you connect the camera to an external recorder/player, you can remotely command the recorder/player to start/stop recording using the camera.

1 MENU →  (Setup) → [HDMI Settings] → [ REC Control] → desired setting.

### Menu item details

On:







 STBY The camera can send a recording command to an external recorder/player.

 REC The camera is sending a recording command to an external recorder/player.

Off:

The camera is not able to send a command to an external recorder/player to start/stop recording.

#### Note

- Available for external recorders/players compatible with [ REC Control].
- When you use the [ REC Control] function, set the shooting mode to  (Movie).
- When [ TC Output] is set to [Off], you cannot use the [ REC Control] function.
- Even when  REC is displayed, the external recorder/player may not work properly depending on the settings or status of the recorder/player. Check if the external recorder/player works properly before use.

Interchangeable Lens Digital Camera  
ILCE-7M3 α7III

## HDMI Settings: CTRL FOR HDMI

When connecting this product to a “BRAVIA” Sync-compatible TV using an HDMI cable (sold separately), you can operate this product by aiming the TV remote control at the TV.

**1** MENU →  (Setup) → [HDMI Settings] → [CTRL FOR HDMI] → desired setting.

**2** Connect this product to a “BRAVIA” Sync-compatible TV.

The input of the TV is switched automatically and images on this product are displayed on the TV screen.

**3** Press the SYNC MENU button of the TV’s remote control.

**4** Operate this product using the TV’s remote control.

### Menu item details

#### On:

You can operate this product with a TV’s remote control.

#### Off:

You cannot operate this product with a TV’s remote control.



#### Note

- If you connect this product to a TV using an HDMI cable, available menu items are limited.
- [CTRL FOR HDMI] is available only with a “BRAVIA” Sync-compatible TV. Also, the SYNC MENU operation differs depending on the TV you are using. For details, refer to the operating instructions supplied with the TV.
- If the product performs unwanted operations in response to the TV remote control when the product is connected to another manufacturer’s TV using an HDMI connection, select MENU →  (Setup) → [HDMI Settings] → [CTRL FOR HDMI] → [Off].

Interchangeable Lens Digital Camera  
ILCE-7M3 α7III

## 4K Output Sel. (movie)

You can set how to record movies and perform HDMI output when your camera is connected to 4K-compatible external recording/playback devices, etc.

- 1 Turn the mode dial to  (movie).
- 2 Connect the camera to the desired device via an HDMI cable.
- 3 MENU →  (Setup) → [ 4K Output Sel.] → desired setting.

### Menu item details

#### Memory Card+HDMI:

Simultaneously outputs to the external recording/playback device and records on the camera's memory card.

#### HDMI Only(30p):

Outputs a 4K movie in 30p to the external recording/playback device without recording on the camera's memory card.

#### HDMI Only(24p):

Outputs a 4K movie in 24p to the external recording/playback device without recording on the camera's memory card.

#### HDMI Only(25p)\*:

Outputs a 4K movie in 25p to the external recording/playback device without recording on the camera's memory card.

\* Only when [NTSC/PAL Selector] is set to PAL.

### Note

- This item can be set only when the camera is in movie mode and connected to a 4K-compatible device.
- When [HDMI Only(30p)], [HDMI Only(24p)] or [HDMI Only(25p)] is set, [HDMI Info. Display] will temporarily be set to [Off].
- A 4K movie is not output to the connected 4K-compatible device during slow-motion/quick-motion shooting.
- When [HDMI Only(30p)], [HDMI Only(24p)] or [HDMI Only(25p)] is set, the counter does not move forward (the actual recording time is not counted) while the movie is being recorded on an external recording/playback device.
- When [ File Format] is set to [XAVC S 4K] and the camera is connected via HDMI, the following functions are not available.
  - [Face Priority in AF]
  - [Face Prty in Mlti Mtr]
  - [Center Lock-on AF]

### Related Topic

- [HDMI Settings: REC Control \(movie\)](#)
- [File Format \(movie\)](#)
- [Record Setting \(movie\)](#)
- [HDMI Settings: HDMI Info. Display](#)

Interchangeable Lens Digital Camera  
ILCE-7M3 α7III

## USB Connection

---

Selects the USB connection method when this product is connected to a computer, etc.  
Select MENU →  (Network) → [Ctrl w/ Smartphone] → [Ctrl w/ Smartphone] → [Off] beforehand.

1 MENU →  (Setup) → [USB Connection] → **desired setting.**

### Menu item details

#### Auto:

Establishes a Mass Storage or MTP connection automatically, depending on the computer or other USB devices to be connected. Windows 7, Windows 8.1, or Windows 10 computers are connected in MTP, and their unique functions are enabled for use.

#### Mass Storage:

Establishes a Mass Storage connection between this product, a computer, and other USB devices.

#### MTP:

Establishes an MTP connection between this product, a computer, and other USB devices. Windows 7, Windows 8.1, or Windows 10 computers are connected in MTP, and their unique functions are enabled for use.

- The memory card in memory card slot 1 is the connection target.

#### PC Remote:

Uses Imaging Edge to control the product from a computer, including such functions as shooting and storing images on the computer.

#### Note

- It may take some time to make the connection between this product and a computer when [USB Connection] is set to [Auto].

---

### Related Topic

- [PC Remote Settings: Still Img. Save Dest.](#)
- [PC Remote Settings: RAW+J PC Save Img](#)

Interchangeable Lens Digital Camera  
ILCE-7M3 α7III

## USB LUN Setting

---

Enhances compatibility by limiting of USB connection functions.

**1** MENU →  (Setup) → [USB LUN Setting] → desired setting.

### Menu item details

**Multi:**

Normally, use [Multi].

**Single:**

Set [USB LUN Setting] to [Single] only if you cannot make a connection.

Interchangeable Lens Digital Camera  
ILCE-7M3 α7III

## USB Power Supply

---

Sets whether to supply power via the USB cable when the product is connected to a computer or an USB device.

1 MENU →  (Setup) → [USB Power Supply] → desired setting.

### Menu item details

#### On:

Power is supplied to the product via a USB cable when the product is connected to a computer, etc.

#### Off:

Power is not supplied to the product via a USB cable when the product is connected to a computer, etc. If you use the supplied AC Adaptor, power will be supplied even when [Off] is selected.

#### Note

- Insert the battery pack into the product to supply power via USB cable.



Interchangeable Lens Digital Camera  
ILCE-7M3 α7III

## PC Remote Settings: Still Img. Save Dest.

Sets whether to save still images stored in both the camera and the computer during PC Remote shooting. This setting is useful when you want to check recorded images on the camera without leaving the camera.

\* PC Remote: Uses Imaging Edge to control the product from a computer, including such functions as shooting and storing images on the computer.

1 MENU →  (Setup) → [PC Remote Settings] → [Still Img. Save Dest.] → desired setting.

### Menu item details

#### PC Only:

Saves still images only on the computer.

#### PC+Camera:

Saves still images on the computer and the camera.

#### Note

- During PC Remote shooting, you cannot change settings for [Still Img. Save Dest.]. Adjust the settings before you start shooting.
- If you insert a memory card that is not recordable, you cannot shoot still images even if you select [PC+Camera].
- If you select [PC+Camera] and you have not inserted a memory card into the camera, you cannot release the shutter even if [Release w/o Card] is set to [Enable].
- During PC Remote shooting, [Recording Mode] under [Rec. Media Settings] is locked to [Standard] and cannot be changed.
- While you are playing back still images on the camera, you cannot shoot using PC Remote.

### Related Topic

- [USB Connection](#)
- [Release w/o Card](#)
- [PC Remote Settings: RAW+J PC Save Img](#)

Interchangeable Lens Digital Camera  
ILCE-7M3 α7III

## PC Remote Settings: RAW+J PC Save Img

Selects the file type for images to be transferred to the computer in PC Remote shooting.

When shooting still images using PC Remote, the application on the computer does not display the image until the image has been completely transferred. When performing RAW+JPEG shooting, you can accelerate the display processing speed by transferring only JPEG images instead of transferring both RAW and JPEG images.

\* PC Remote: Uses Imaging Edge to control the product from a computer, including such functions as shooting and storing images on the computer.

1 **MENU** →  (Setup) → **[PC Remote Settings]** → **[RAW+J PC Save Img]** → **desired setting.**

### Menu item details

#### RAW & JPEG:

Transfers both RAW and JPEG files to the computer.

#### JPEG Only:

Transfers only JPEG files to the computer.

#### RAW Only:

Transfers only RAW files to the computer.

#### Note

- The setting for [RAW+J PC Save Img] cannot be changed during PC Remote shooting. Adjust the setting before shooting.
- [RAW+J PC Save Img] can be set only when [ File Format] is set to [RAW & JPEG].
- During PC Remote shooting, [Recording Mode] under [Rec. Media Settings] is locked to [Standard] and cannot be changed.

### Related Topic

- [USB Connection](#)
- [File Format \(still image\)](#)
- [PC Remote Settings: Still Img. Save Dest.](#)

Interchangeable Lens Digital Camera  
ILCE-7M3 α7III

## Language

---

Selects the language to be used in the menu items, warnings and messages.

**1** MENU →  (Setup) → [ Language] → **desired language.**

Interchangeable Lens Digital Camera  
ILCE-7M3 α7III

## Date/Time Setup

---

The Clock Set screen is displayed automatically when you turn on this product for the first time or when the internal rechargeable backup battery has fully discharged. Select this menu when setting the date and time after the first time.

1 MENU →  (Setup) → [Date/Time Setup] → desired setting.

### Menu item details

**Daylight Savings:**

Selects Daylight Savings [On]/[Off].

**Date/Time:**

Sets the date and time.

**Date Format:**

Selects the date and time display format.

#### Hint

- To charge the internal rechargeable backup battery, insert a charged battery pack, and leave the product for 24 hours or more with the power off.
- If the clock resets every time the battery is charged, the internal rechargeable backup battery may be worn out. Consult your service facility.

Interchangeable Lens Digital Camera  
ILCE-7M3 α7III

## Area Setting

---

Sets the area where you are using the product.

**1** MENU →  (Setup) → [Area Setting] → desired area.

Interchangeable Lens Digital Camera  
ILCE-7M3 α7III

## Copyright Info

---

Writes copyright information onto the still images.

- 1 **MENU** →  (**Setup**) → **[Copyright Info]** → **desired setting**.
- 2 **When you select [Set Photographer] or [Set Copyright], a keyboard appears on the screen. Enter your desired name.**

### Menu item details

#### Write Copyright Info:

Sets whether to write copyright information. ([On]/[Off])

- If you select [On], an  icon will appear on the shooting screen.

#### Set Photographer:

Sets the photographer name.

#### Set Copyright:

Sets the copyright holder name.

#### Disp. Copyright Info:

Displays the current copyright information.

#### Note

- You can only enter alphanumeric characters and symbols for [Set Photographer] and [Set Copyright]. You can enter up to 46 letters.
- A  icon appears during the playback of images with copyright information.
- In order to prevent unauthorized use of [Copyright Info], be sure to clear the [Set Photographer] and [Set Copyright] columns before lending out or handing over your camera.
- Sony is not liable for problems or damages resulting from use of [Copyright Info].

---

### Related Topic

- [How to use the keyboard](#)

Interchangeable Lens Digital Camera  
ILCE-7M3 α7III

## Format

---

When you use a memory card with this camera for the first time, we recommend that you format the card using the camera for stable performance of the memory card. Note that formatting permanently erases all data on the memory card, and is unrecoverable. Save valuable data on a computer, etc.

1 MENU →  (Setup) → [Format] → desired memory card slot.

### Note

- Formatting permanently erases all data including protected images and registered settings (from M1 to M4).
- The access lamp lights up during formatting. Do not remove the memory card while the access lamp is lit up.
- Format the memory card on this camera. If you format the memory card on the computer, the memory card may not be usable depending on the format type.
- It may take a few minutes to complete formatting, depending on the memory card.
- You cannot format the memory card if the remaining battery charge is less than 1%.

Interchangeable Lens Digital Camera  
ILCE-7M3 α7III

## File Number

---

Selects how to assign file numbers to still images.

**1** MENU →  (Setup) → [File Number] → desired setting.

### Menu item details

**Series:**

The product will assign numbers to files sequentially up to "9999" without resetting.

**Reset:**

The product resets numbers when a file is recorded in a new folder and assigns numbers to files starting with "0001". (When the recording folder contains a file, a number one higher than the largest number is assigned.)

**Hint**

- The setting for [File Number] will be applied to both slot 1 and slot 2.
- Even if you change the setting of [Prioritize Rec. Media], the file numbers will be sequential across the two memory cards in each slot by setting [File Number] to [Series].



Interchangeable Lens Digital Camera  
ILCE-7M3 α7III

## Set File Name

---

You can specify the first three characters of the file name for images you shoot.

- 1 MENU →  (Setup) → [Set File Name].
- 2 Select the entry field for the file name to display a keyboard on the screen, and then enter three characters of your choice.
  - The setting for [Set File Name] will be applied to both slot 1 and slot 2.

### Note

- Only capital letters, numbers, and underscores can be entered. However, an underscore cannot be used as the first character.
- The three characters of the file name you specify using [Set File Name] will only be applied to images you shoot after changing the setting.

---

### Related Topic

- [How to use the keyboard](#)

Interchangeable Lens Digital Camera  
ILCE-7M3 α7III

## Rec. Media Settings: Prioritize Rec. Media

---

Selects the memory card slot on which to record. [Slot 1] is the default setting. If you do not intend to change the settings and will only use one memory card, use the slot 1.

1 MENU →  (Setup) → [Rec. Media Settings] → [Prioritize Rec. Media] → desired slot.

### Menu item details

#### Slot 1:

Selects media in the slot 1.

#### Slot 2:

Selects media in the slot 2.

#### Hint

- To record the same image on two memory cards at the same time or to sort recorded images onto two memory card slots by the image type (still image/movie), use [Recording Mode].

#### Note

- The slot 2 supports Memory Stick PRO Duo media and SD cards. The slot 1 supports SD cards only.

---

### Related Topic

- [Memory cards that can be used](#)
- [Rec. Media Settings: Recording Mode](#)

Interchangeable Lens Digital Camera  
ILCE-7M3 α7III

## Rec. Media Settings: Recording Mode

You can select the method for recording an image, such as recording the same image simultaneously to two memory cards or recording different types of images to two memory cards.

1 MENU →  (Setup) → [Rec. Media Settings] → [Recording Mode] → desired setting.

### Menu item details

#### Standard:

Records an image to a memory card in the memory card slot that you select in [Prioritize Rec. Media].

#### Simult. ():

Records a still image to both memory cards and records a movie to a memory card in the memory card slot that you select in [Prioritize Rec. Media].

#### Simult. ():

Records a still image to a memory card in the memory card slot that you select in [Prioritize Rec. Media], and records a movie to both memory cards.

#### Simult. ( / ):

Records a still image and a movie to both memory cards.

#### Sort(RAW/JPEG):

Records an image in RAW format to a memory card in the memory card slot that you select in [Prioritize Rec. Media], and records an image in JPEG format to the other memory card. Movies are recorded to the memory card in the memory card slot that you selected in [Prioritize Rec. Media].

#### Sort(JPEG/RAW):

Records an image in JPEG format to a memory card in the memory card slot that you select in [Prioritize Rec. Media], and records an image in RAW format to the other memory card. Movies are recorded to the memory card in the memory card slot that you selected in [Prioritize Rec. Media].

#### Sort( / ):

Records a still image to a memory card in the memory card slot that you select in [Prioritize Rec. Media], and records a movie to the other memory card.

#### Hint

- Even when [Recording Mode] is set to [Sort(RAW/JPEG)] or [Sort(JPEG/RAW)], if [RAW & JPEG] is not selected under [ File Format], only files of the selected format will be recorded.

### Related Topic

- [Memory cards that can be used](#)
- [Rec. Media Settings: Prioritize Rec. Media](#)

## Rec. Media Settings: Auto Switch Media

If a memory card in use becomes full or you have forgotten to insert a memory card into a slot, you can record images to the other memory card.

1 MENU →  (Setup) → [Rec. Media Settings] → [Auto Switch Media] → desired setting.

### Menu item details

**On:**  
The camera automatically starts recording on the other memory card when a memory card in use becomes full or if you have forgotten to insert a memory card.

**Off:**  
The camera does not perform [Auto Switch Media].

### How the camera switches the memory card slot in use

**When [Recording Mode] is set to [Standard]:**

When images cannot be recorded to the memory card in use, [Prioritize Rec. Media] switches automatically and images are recorded to the other memory card.

When the other memory card becomes full after switching, the camera starts recording in the former slot again.

Example: When [Prioritize Rec. Media] is set to [Slot 1]

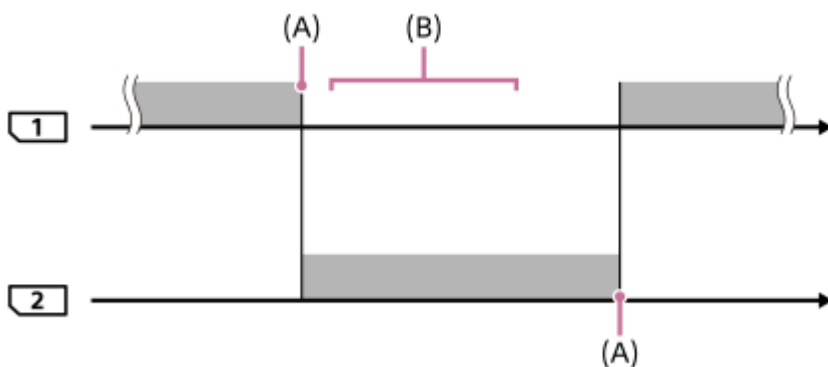





 : Recording images

(A): Recording is no longer possible on the memory card (due to lack of capacity, etc.).

(B): The memory card is replaced with a recordable one.

### When recording the same image simultaneously to two memory cards:

- Recording still images with [Recording Mode] set to [Simult. (  )]
- Recording movies with [Recording Mode] set to [Simult. (  )]
- Recording still images or movies with [Recording Mode] set to [Simult. (  /  )]

The camera stops simultaneous recording when either of the memory cards becomes full. When you remove the memory card that has become full, the camera starts recording to the other memory card.

When you replace the memory card that has become full with a recordable memory card, the camera starts simultaneous recording with the selected setting again.

Example: When [Prioritize Rec. Media] is set to [Slot 1]  
 ([Recording Mode]: [Simult. ( / )])

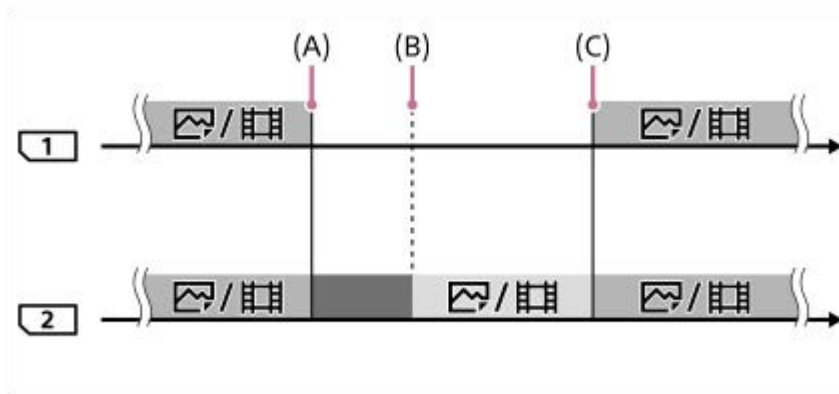

: Simultaneous recording is available.  
 : Recording is disabled.  
 : The same image cannot be recorded simultaneously.

(A): Recording is no longer possible on the memory card (due to lack of capacity, etc.).  
 (B): The memory card is removed.  
 (C): A recordable memory card is inserted.

- Images that are not recorded simultaneously (for example: still images during [Simult. ( / )]) continue to be recorded to the other memory card when the memory card in use becomes full.
- When the memory card in use becomes full while recording a movie, the movie continues to be recorded to the other memory card until the recording in progress is finished.

**When recording images separately to two memory cards in the RAW and JPEG formats:**

- When [Recording Mode] is set to [Sort(RAW/JPEG)] or [Sort(JPEG/RAW)], and [ File Format] is set to [RAW & JPEG]

The camera stops recording when either of the memory cards becomes full. When you remove the memory card that has become full, the camera starts recording both in the RAW and JPEG formats to the other memory card. When you replace the memory card that has become full with a recordable memory card, the camera starts recording the two types of images separately with the selected setting again.

Example: When [Prioritize Rec. Media] is set to [Slot 1]  
 ([Recording Mode]: [Sort(RAW/JPEG)])

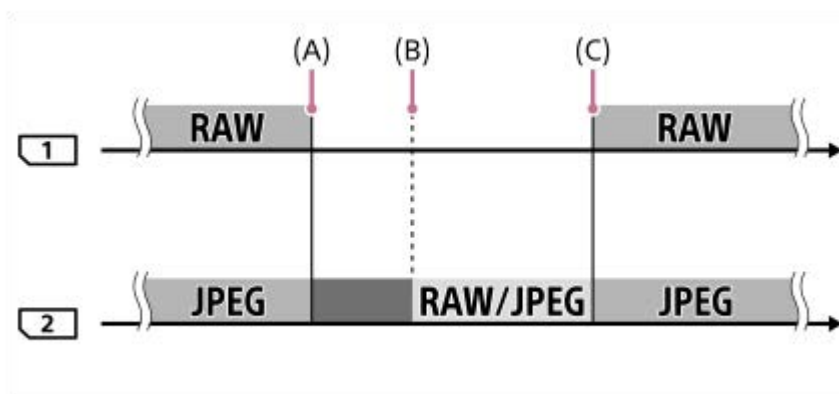

: Images are sorted by the file format.  
 : Recording still images is disabled (movies can be recorded).  
 : Images cannot be sorted.

(A): Recording is no longer possible on the memory card (due to lack of capacity, etc.).  
 (B): The memory card is removed.

(C): A recordable memory card is inserted.

- When the memory card in use becomes full while recording movies, the camera starts recording to the other memory card.

### When recording still images and movies separately to two memory cards:

- When [Recording Mode] is set to [Sort(📷/🎥)]

When either of the memory cards becomes full, both still images and movies are recorded to the other memory card. When you replace the memory card that has become full with a recordable memory card, the camera starts recording the two types of images separately with the selected setting again.

Example: When [Prioritize Rec. Media] is set to [Slot 1]

([Recording Mode]: [Sort(📷/🎥)])

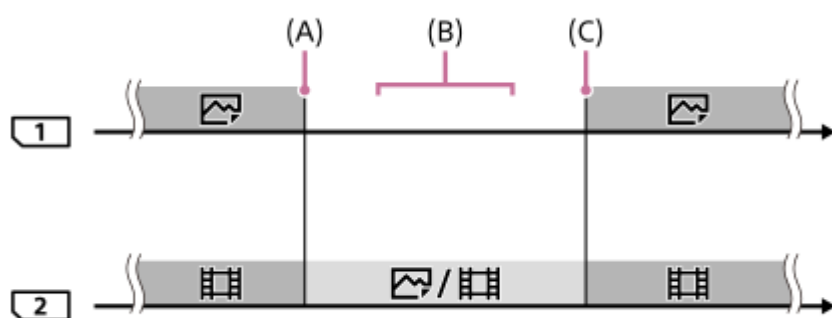

■ : Images are sorted by the image type.

□ : Images cannot be sorted.

(A): Recording is no longer possible on the memory card (due to lack of capacity, etc.).

(B): The memory card is removed.

(C): A recordable memory card is inserted.

#### Hint

- Images are recorded to the memory card in the slot displayed on the monitor with an arrow symbol. After the camera switches the slot using [Auto Switch Media], replace the memory card in the former slot with a recordable memory card.
- If [Recording Mode] is set to [Standard], the setting for [Prioritize Rec. Media] will switch automatically when the slot switches. If you want to record on the slot in use before switching, select the desired slot again using [Prioritize Rec. Media].
- If you want to continually record with the settings selected with [Recording Mode] and [Prioritize Rec. Media], set [Auto Switch Media] to [Off].
- Even when the camera records a movie on two memory cards using [Auto Switch Media], the continuous recordable time is approximately 29 minutes per recording.

#### Related Topic

- [Memory cards that can be used](#)
- [Recordable movie times](#)
- [Rec. Media Settings: Prioritize Rec. Media](#)

Interchangeable Lens Digital Camera  
ILCE-7M3 α7III

## Select REC Folder

---

If [Folder Name] is set to [Standard Form] and there are 2 folders or more, you can select the folder on the memory card to which images are to be recorded.

**1** MENU →  (Setup) → [Select REC Folder] → desired folder.

### Note

- You cannot select the folder when [Folder Name] is set to [Date Form].
- If [Recording Mode] is set to other than [Standard], you may only select the common folder on the both memory cards. If there is no common folder, you can make one using [New Folder].

---

### Related Topic

- [Folder Name](#)
- [Rec. Media Settings: Recording Mode](#)

Interchangeable Lens Digital Camera  
ILCE-7M3 α7III

## New Folder

---

Creates a new folder on the memory card for recording still images. A new folder is created with a folder number one greater than the largest folder number currently used. Images are recorded in the newly created folder.

1 MENU →  (Setup) → [New Folder].

### Note

- When you insert a memory card that was used with other equipment into this product and shoot images, a new folder may be automatically created.
- Up to 4,000 images in total can be stored in one folder. When the folder capacity is exceeded, a new folder may be automatically created.
- If [Recording Mode] is set to other than [Standard], a new folder is created with a folder number one greater than the largest folder number currently used on both memory cards inserted in the memory card slots.
- If [Recording Mode] is set to other than [Standard] and an image is shot, a new folder may be automatically created.

---

### Related Topic

- [Rec. Media Settings: Recording Mode](#)



Interchangeable Lens Digital Camera  
ILCE-7M3 α7III

## Folder Name

---

Still images are recorded in a folder that is automatically created inside the DCIM folder on the memory card. You can change the way folder names are assigned.

**1** MENU →  (Setup) → [Folder Name] → desired setting.

### Menu item details

#### Standard Form:

The folder name form is as follows: folder number + MSDCF.

Example: 100MSDCF

#### Date Form:

The folder name form is as follows: folder number + Y (the last digit)/MM/DD.

Example: 10070405 (Folder number: 100, date: 04/05/2017)

#### Note

- You cannot change the [Folder Name] settings for movies.

Interchangeable Lens Digital Camera  
ILCE-7M3 α7III

## Recover Image DB

---

If image files were processed on a computer, problems may occur in the image database file. In such cases, the images on the memory card will not be played back on this product. If these problems happen, repair the file using [Recover Image DB].

**1** MENU →  (Setup) → [Recover Image DB] → desired memory card slot → [Enter].

### Note

- Use a sufficiently charged battery pack. Low battery power during repairing can cause damage to data.

Interchangeable Lens Digital Camera  
ILCE-7M3 α7III

## Display Media Info.

---

Displays the recordable time of movies for the inserted memory card. Also displays the number of recordable still images for the inserted memory card.

**1** MENU →  (Setup) → [Display Media Info.] → desired memory card slot.

Interchangeable Lens Digital Camera  
ILCE-7M3 α7III

## Version

---

Displays the version of this product's software. Check the version when updates for this product's software are released, etc.

Also displays the version of the lens if a lens compatible with firmware updates is attached.

The version of the Mount Adaptor is displayed in the lens area if a Mount Adaptor compatible with firmware updates is attached.

1 MENU →  (Setup) → [Version].

### Note

- Updating can be performed only when the battery level is  (3 remaining battery bars) or more. Use a sufficiently charged battery pack.

Interchangeable Lens Digital Camera  
ILCE-7M3 α7III

## Setting Reset

---

Resets the product to the default settings. Even if you perform [Setting Reset], the recorded images are retained.

**1** MENU →  (Setup) → [Setting Reset] → desired setting.

### Menu item details

#### Camera Settings Reset:

Initializes the main shooting settings to the default settings.

#### Initialize:

Initializes all the settings to the default settings.

#### Note

- Be sure not to eject the battery pack while resetting.
- The value set with [AF Micro Adj.] will not be reset even when [Camera Settings Reset] or [Initialize] is performed.
- Settings of [Picture Profile] will not be reset even when [Camera Settings Reset] or [Initialize] is performed.

---

### Related Topic

- [AF Micro Adj.](#)
- [List of default setting values](#)

## Add Item

---

You can register the desired menu items to ★ (My Menu) under MENU.

- 1 MENU → ★ (My Menu) → [Add Item].
- 2 Select an item that you want to add to ★ (My Menu) using the top/bottom/left/right sides of the control wheel.
- 3 Select a destination using the top/bottom/left/right sides of the control wheel.

### Hint

- You can add up to 30 items to ★ (My Menu).

### Note

- You cannot add the following items to ★ (My Menu).
  - Any item under MENU →  (Playback)
  - [View on TV]

---

### Related Topic

- [Sort Item](#)
- [Delete Item](#)
- [Using MENU items](#)

Interchangeable Lens Digital Camera  
ILCE-7M3 α7III

## Sort Item

---

You can rearrange the menu items added to ★ (My Menu) under MENU.

- 1 MENU → ★ (My Menu) → [Sort Item].
  - 2 Select an item that you want to move using the top/bottom/left/right sides of the control wheel.
  - 3 Select a destination using the top/bottom/left/right sides of the control wheel.
- 

### Related Topic

- [Add Item](#)

Interchangeable Lens Digital Camera  
ILCE-7M3 α7III

## Delete Item

---

You can delete menu items added to ★ (My Menu) of MENU.

- 1 MENU → ★ (My Menu) → [Delete Item].
- 2 Select an item that you want to delete using the top/bottom/left/right sides of the control wheel, and then press the center to delete the selected item.

### Hint

- To delete all the items on a page, select MENU → ★ (My Menu) → [Delete Page].
- You can delete all the items added to ★ (My Menu) by selecting MENU → ★ (My Menu) → [Delete All].

---

### Related Topic

- [Delete Page](#)
- [Delete All](#)
- [Add Item](#)



Interchangeable Lens Digital Camera  
ILCE-7M3 α7III

## Delete Page

---

You can delete all the menu items added to a page under ★ (My Menu) in MENU.

**1** MENU → ★ (My Menu) → [Delete Page].

**2** Select a page that you want to delete using the left/right sides of the control wheel, and then press the center of the control wheel to delete the items.

---

### Related Topic

- [Add Item](#)
- [Delete All](#)

Interchangeable Lens Digital Camera  
ILCE-7M3 α7III

## Delete All

---

You can delete all the menu items added to ★ (My Menu) in MENU.

- 1 MENU → ★ (My Menu) → [Delete All].
  - 2 Select [OK].
- 

### Related Topic

- [Add Item](#)
- [Delete Page](#)

Interchangeable Lens Digital Camera  
ILCE-7M3 α7III

## Precautions

---

Refer also to “Notes on using your camera” in the Instruction Manual (supplied) for this product.

### Backing up memory cards

Data may be corrupted in the following cases. Be sure to back up the data for protection.

- When the memory card is removed, the USB cable is disconnected, or the product is turned off in the middle of a read or write operation.
- When the memory card is used in locations subject to static electricity or electrical noise.

### Database file error

If you insert a memory card that does not contain an image database file into the product and turn on the power, the product automatically creates an image database file using some of the memory card's capacity. The process may take a long time and you cannot operate the product until the process is completed.

If a database file error occurs, export all images to your computer using PlayMemories Home, and then format the memory card using this product.

### Do not use/store the product in the following places

- In an extremely hot, cold or humid place  
In places such as in a car parked in the sun, the camera body may become deformed and this may cause a malfunction.
- Storing under direct sunlight or near a heater  
The camera body may become discolored or deformed, and this may cause a malfunction.
- In a location subject to rocking vibration
- Near strong magnetic place
- In sandy or dusty places  
Be careful not to let sand or dust get into the product. This may cause the product to malfunction, and in some cases this malfunction cannot be repaired.
- In places with high humidity  
This may cause the lens to mold.

### On storing

If the camera is dirty after use, clean it. Water, sand, dust, salt, etc. left in the camera may cause a malfunction.

### Precaution on carrying

- Do not carry the camera with the tripod attached. This may cause the tripod socket hole to break.
- Do not apply excessive force to the camera, such as by holding the monitor or flash part, hitting the lens part, etc.

### On operating temperatures

Shooting in extremely cold or hot places that exceed this range is not recommended.

### On moisture condensation

- If the product is brought directly from a cold to a warm location, moisture may condense inside or outside the product. This moisture condensation may cause a malfunction of the product.
- To prevent moisture condensation when you bring the product directly from a cold to a warm location, first put it in a plastic bag and seal it to prevent air from entering. Wait for about an hour until the temperature of the product has

reached the ambient temperature.

- If moisture condensation occurs, turn off the product and wait about an hour for the moisture to evaporate. Note that if you attempt to shoot with moisture remaining inside the lens, you will be unable to record clear images.

## **On image data compatibility**

This product conforms with DCF (Design rule for Camera File system) universal standard established by JEITA (Japan Electronics and Information Technology Industries Association).

## **Notes on playing movies on other devices**

XAVC S movies can be played back only on XAVC S-supported devices.

## **On the monitor and viewfinder**

- If you use the camera in a cold location, the image may have a trailing appearance. This is not a malfunction.
- Do not press against the monitor. The monitor may be discolored and that may cause a malfunction.
- If the monitor has drops of water or other liquids on it, wipe it with a soft cloth. If the monitor stays wet, the surface of the monitor may change or deteriorate. This may cause a malfunction.
- If the subject is too close, the image may show any dust or fingerprints on the lens. Wipe the lens with a soft cloth, etc.
- The camera uses magnetic parts including magnets. Do not bring objects affected by magnetism, including credit cards and floppy disks, close to the camera.

Interchangeable Lens Digital Camera  
ILCE-7M3 α7III

## On cleaning

---

### Cleaning the lens

- Do not use a cleaning solution containing organic solvents, such as thinner, or benzine.
- When cleaning the lens surface, remove dust with a commercially available blower. In case of dust that sticks to the surface, wipe it off with a soft cloth or tissue paper slightly moistened with lens cleaning solution. Wipe in a spiral pattern from the center to the outside. Do not spray lens cleaning solution directly onto the lens surface.

### Cleaning the camera body

Do not touch the parts of the product inside the lens mount, such as a lens signal contact. To clean inside the lens mount, use a commercially available blower\* to blow any dust off.

\* Do not use a spray-type blower as doing so may cause a malfunction.

### Cleaning the product surface

Clean the product surface with a soft cloth slightly moistened with water, then wipe the surface with a dry cloth. To prevent damage to the finish or casing:

- Do not expose the product to chemical products such as thinner, benzine, alcohol, disposable cloths, insect repellent, sunscreen or insecticide.
- Do not touch the product with any of the above on your hand.
- Do not leave the product in contact with rubber or vinyl for a long time.

### Cleaning the monitor

- If you wipe the monitor firmly using tissue paper, etc., the coating may be scratched.
- If the monitor becomes dirty with fingerprints or dust, gently remove the dust from the surface, and then clean the monitor using soft cloth, etc.

Interchangeable Lens Digital Camera  
ILCE-7M3 α7III

## Cleaning Mode

If dust or debris gets inside the camera and adheres to the surface of the image sensor (the part that converts the light to an electric signal), it may appear as dark spots on the image, depending on the shooting environment. If this happens, follow the steps below to clean the image sensor.

- 1 **Confirm that the battery has been charged sufficiently.**
- 2 **MENU** →  (**Setup**) → **[Cleaning Mode]** → **[Enter]**.  
The image sensor vibrates a little to shake off the dust.
- 3 **Turn off the product following the instructions on the screen.**
- 4 **Detach the lens.**
- 5 **Use the blower to clean the image sensor surface and the surrounding area.**

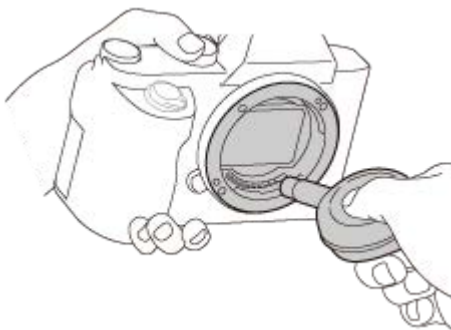

- 6 **Attach the lens.**

### Hint

- For how to check the amount of dust on the image sensor, and for further details on cleaning methods, please refer to the following URL.  
<http://support.d-imaging.sony.co.jp/www/support/ilc/sensor/index.php>

### Note

- Clean the image sensor quickly.
- A blower is not supplied with this product. Use a commercially available blower.
- Make sure that the remaining battery level is  (3 remaining battery icons) or more, before performing the cleaning. The use of AC adaptor (supplied) is recommended.
- Do not use a spray type blower as it may scatter water droplets inside the camera body.
- Do not put the tip of a blower into the cavity beyond the lens mount area, so that the tip of the blower does not touch the image sensor.

- Hold the camera slightly face downward so that the dust falls out.
- Do not subject the product to any shock during cleaning.
- When cleaning the image sensor with a blower, do not blow too hard. If you blow the sensor too hard, the inside of the product may be damaged.
- If the dust remains even after you cleaned the product as described, consult the service facility.

---

### Related Topic

- [Troubleshooting](#)

4-732-947-11(1) Copyright 2018 Sony Corporation

Interchangeable Lens Digital Camera  
ILCE-7M3 α7III

## Number of recordable images

When you insert a memory card into the camera and set the ON/OFF (Power) switch to "ON," the number of images that can be recorded (should you continue to shoot using the current settings) is displayed on the screen.

### Note

- When "0" (the number of recordable images) flashes in orange, the memory card is full. Replace the memory card with another one, or delete images from the current memory card.
- When "NO CARD" flashes in orange, it means no memory card has been inserted. Insert a memory card.

### The number of images that can be recorded on a memory card



The table below shows the approximate number of images that can be recorded on a memory card formatted with this camera. The values are defined using Sony standard memory cards for testing.

The values may vary depending on the shooting conditions and the type of memory card used.

[ JPEG Image Size]: [L: 24M]

[ Aspect Ratio]: [3:2]<sup>\*1</sup>

(Units: Images)

 JPEG Quality/  File Format	8 GB	32 GB	64 GB	256 GB
Standard	1100	4600	9200	36000
Fine	790	3200	6400	25000
Extra fine	435	1750	3500	14000
RAW & JPEG (Compressed RAW) <sup>*2</sup>	215	870	1750	7000
RAW (Compressed RAW)	295	1200	2400	9600
RAW & JPEG (Uncompressed RAW) <sup>*2</sup>	125	510	1000	4100
RAW (Uncompressed RAW)	150	610	1200	4950

\*1 When [ Aspect Ratio] is set to other than [3:2], you can record more images than the numbers shown in the table above. (except when [RAW] is selected)

\*2 [ JPEG Quality] when [RAW & JPEG] is selected: [Fine]

### Note



- Even if the number of recordable images is higher than 9999 images, "9999" will appear.
- The numbers shown are when using a Sony memory card.



Interchangeable Lens Digital Camera  
ILCE-7M3 α7III

## Recordable movie times



The table below shows the approximate total recording times using a memory card formatted with this camera. The values may vary depending on the shooting conditions and the type of memory card used.

The recording times for when [  File Format ] is set to [XAVC S 4K] and [XAVC S HD] are recording times when shooting with [  Proxy Recording ] set to [Off].

(h (hour), m (minute))

	8 GB	32 GB	64 GB	256 GB
XAVC S 4K 30p 100M/25p 100M	8 m	35 m	1 h 15 m	5 h 15 m
XAVC S 4K 30p 60M/25p 60M	10 m	1 h	2 h 5 m	8 h 35 m
XAVC S 4K 24p 100M*/–	8 m	35 m	1 h 15 m	5 h 15 m
XAVC S 4K 24p 60M*/–	10 m	1 h	2 h 5 m	8 h 35 m
XAVC S HD 120p 100M/100p 100M	8 m	35 m	1 h 15 m	5 h 15 m
XAVC S HD 120p 60M/100p 60M	10 m	1 h	2 h 5 m	8 h 35 m
XAVC S HD 60p 50M/50p 50M	15 m	1 h 15 m	2 h 30 m	10 h 25 m
XAVC S HD 60p 25M/50p 25M	30 m	2 h 25 m	5 h	20 h 10 m
XAVC S HD 30p 50M/25p 50M	15 m	1 h 15 m	2 h 30 m	10 h 25 m
XAVC S HD 30p 16M/25p 16M	50 m	3 h 50 m	7 h 45 m	31 h 25 m
XAVC S HD 24p 50M*/–	15 m	1 h 15 m	2 h 30 m	10 h 25 m
AVCHD 60i 24M(FX)/50i 24M(FX)	40 m	2 h 55 m	6 h	24 h 15 m
AVCHD 60i 17M(FH)/50i 17M(FH)	55 m	4 h 5 m	8 h 15 m	33 h 15 m

\* Only when [NTSC/PAL Selector] is set to NTSC.

- Continuous shooting is possible for approximately 29 minutes (a product specification limit).  
The continuous recordable time may differ in the following situations:
  - When shooting slow-motion/quick-motion movies: Recording will automatically stop when the recorded file reaches approximately 29 minutes (the played back movie reaches approximately 29 minutes). (Recording will automatically stop when the recorded file reaches approximately 15 minutes if [  S&Q Record Setting ] is set to [60p/50p] and [  S&Q Frame Rate ] is set to [30fps/25fps].)
- The times for slow-motion/quick-motion movies are playback times, not recording times.

### Note

- The recordable time of movies varies because the camera is equipped with VBR (Variable Bit-Rate), which automatically adjusts image quality depending on the shooting scene. When you record a fast-moving subject, the image is clearer but the recordable time is shorter because more memory is required for recording. The recordable time also varies depending on the shooting conditions, the subject or the image quality/size settings.
- The times shown are recordable times using a Sony memory card.

## Notes on continuous movie recording

- High-quality movie recording and high-speed continuous shooting require large amounts of power. Therefore, if you continue to shoot, the temperature inside the camera will rise, especially that of the image sensor. In such cases, the camera will turn off automatically because the surface of the camera is heated to a high temperature or the high temperature affects the quality of the images or the internal mechanism of the camera.
- The duration of time available for continuous movie recording when the camera records with the default settings after the power has been turned off for a while is as follows. The values indicate the continuous time from when the camera starts recording until the camera stops recording.

Ambient temperature: 20°C (68°F)

- Continuous recording time for movies (HD): Approx. 29 minutes
- Continuous recording time for movies (4K): Approx. 29 minutes

Ambient temperature: 30°C (86°F)

- Continuous recording time for movies (HD): Approx. 29 minutes
- Continuous recording time for movies (4K): Approx. 29 minutes



Ambient temperature: 40°C (104°F)

- Continuous recording time for movies (HD): Approx. 29 minutes
- Continuous recording time for movies (4K): Approx. 29 minutes

[Auto Pwr OFF Temp.]: [Standard]

HD: XAVC S HD (60p 50M/50p 50M, when the camera is not connected via Wi-Fi)

4K: XAVC S 4K (24p 60M/25p 60M, when the camera is not connected via Wi-Fi)

- The duration of time available for movie recording varies with the temperature, file format/record setting for movies, Wi-Fi network environment, or condition of the camera before you start recording. If you frequently recompose or shoot images after the power is turned on, the temperature inside the camera will rise and the recording time available will be shorter.
- If the  icon appears, the temperature of the camera has risen.
- If the camera stops movie recording due to a high temperature, leave it for some time with the power turned off. Start recording after the temperature inside the camera drops fully.
- If you observe the following points, you will be able to record movies for longer periods of time.
  - Keep the camera out of direct sunlight.
  - Turn the camera off when it is not being used.
- When  File Format] is set to [AVCHD], the file size of movies is limited to approx. 2 GB. If the movie file size reaches approx. 2 GB during recording, a new movie file will be created automatically.

Interchangeable Lens Digital Camera  
ILCE-7M3 α7III

## Using the AC Adaptor/battery charger abroad

---

You can use the battery charger (sold separately) and the AC Adaptor (supplied) in any country or region where the power supply is within 100 V to 240 V AC and 50 Hz/60 Hz.

Depending on the country/region, a converting plug adaptor may be needed to connect to a wall outlet (wall socket). Consult a travel agency, etc., and prepare one in advance.

### Note

- Do not use an electronic voltage transformer as doing so may cause a malfunction.

Interchangeable Lens Digital Camera  
ILCE-7M3 α7III

## AVCHD format

---

The AVCHD format was developed for high-definition digital video cameras when recording an HD (High-Definition) signal using high-efficiency compression coding technology. The MPEG-4 AVC/H.264 format is used to compress video data, and the Dolby Digital or Linear PCM system is used to compress audio data.

The MPEG-4 AVC/H.264 format is capable of compressing images at higher efficiency than that of the conventional image compressing format.

- As the AVCHD format uses compression coding technology, the picture may be unstable in scenes where the screen, angle of view, or brightness, etc. change drastically, but this is not a malfunction.

Interchangeable Lens Digital Camera  
ILCE-7M3 α7III

## License

---

### Notes on the License

This product comes with software that are used based on licensing agreements with the owners of that software. Based on requests by the owners of copyright of these software applications, we have an obligation to inform you of the following. Licenses (in English) are recorded in the internal memory of your product. Establish a Mass Storage connection between the product and a computer to read licenses in the "PMHOME" - "LICENSE" folder.

THIS PRODUCT IS LICENSED UNDER THE AVC PATENT PORTFOLIO LICENSE FOR THE PERSONAL USE OF A CONSUMER OR OTHER USES IN WHICH IT DOES NOT RECEIVE REMUNERATION TO  
(i) ENCODE VIDEO IN COMPLIANCE WITH THE AVC STANDARD ("AVC VIDEO")  
AND/OR  
(ii) DECODE AVC VIDEO THAT WAS ENCODED BY A CONSUMER ENGAGED IN A PERSONAL ACTIVITY AND/OR WAS OBTAINED FROM A VIDEO PROVIDER LICENSED TO PROVIDE AVC VIDEO.  
NO LICENSE IS GRANTED OR SHALL BE IMPLIED FOR ANY OTHER USE. ADDITIONAL INFORMATION INCLUDING THAT RELATING TO PROMOTIONAL, INTERNAL AND COMMERCIAL USES AND LICENSING MAY BE OBTAINED FROM MPEG LA, L.L.C.  
SEE [HTTP://WWW.MPEGLA.COM](http://www.mpegla.com)

### On GNU GPL/LGPL applied software

The software that is eligible for the following GNU General Public License (hereinafter referred to as "GPL") or GNU Lesser General Public License (hereinafter referred to as "LGPL") are included in the product.

This informs you that you have a right to have access to, modify, and redistribute source code for these software programs under the conditions of the supplied GPL/LGPL.

Source code is provided on the web.

Use the following URL to download it.

<http://oss.sony.net/Products/Linux/>

We would prefer you do not contact us about the contents of source code.

Interchangeable Lens Digital Camera  
ILCE-7M3 α7III

## Specifications

---

### Camera

#### [System]

**Camera Type**

Interchangeable Lens Digital Camera

**Lens**

Sony E-mount lens

#### [Image sensor]

**Image format**

35 mm full frame (35.6 mm × 23.8 mm), CMOS image sensor

**Effective pixel number of camera**

Approx. 24 200 000 pixels

**Total pixel number of camera**

Approx. 25 300 000 pixels

#### [SteadyShot]

**System**

In-camera sensor shift image stabilization system

#### [Anti-Dust]

**System**

Charge protection coating on optical filter and image sensor shift mechanism

#### [Auto focus system]

**Detection system**

Phase detection system/Contrast detection system

**Sensitivity Range**

-3 EV to +20 EV (at ISO 100 equivalent, F2.0)

**AF illuminator**

Approx. 0.3 m to 3.0 m (0.99 ft. to 9.8 ft.) (When using an FE 28-70 mm F3.5-5.6 OSS)

#### [Electronic Viewfinder]

**Type**

1.3 cm (0.5 type) Electronic Viewfinder

**Total number of dots**

2 359 296 dots

**Frame coverage**

100%

**Magnification**

Approx. 0.78× with 50 mm lens at infinity,  $-1 \text{ m}^{-1}$

**Eye Point**

Approx. 23 mm from the eyepiece and approx. 18.5 mm from the eyepiece frame at  $-1 \text{ m}^{-1}$

**Diopter Adjustment**

-4.0 m<sup>-1</sup> to +3.0 m<sup>-1</sup>

## [Monitor]

### LCD monitor

7.5 cm (3.0 type) TFT drive, touch panel

### Total number of dots

921 600 dots

## [Exposure control]

### Metering method

1 200-zone evaluative metering

### Metering Range

-3 EV to +20 EV (at ISO 100 equivalent with F2.0 lens)

### ISO sensitivity (Recommended exposure index)

Still images: ISO 100 to ISO 51 200 (Extended ISO: Minimum ISO 50, maximum ISO 204 800), [ISO AUTO] (ISO 100 to 12 800, Maximum/Minimum can be set.)

Movies: ISO 100 to ISO 51 200 equivalent, [ISO AUTO] (ISO 100 to ISO 12 800 equivalent, Maximum/Minimum can be set.)

### Exposure compensation

±5.0 EV (switchable between 1/3 EV and 1/2 EV steps)

When using exposure compensation dial: ±3.0 EV (1/3 EV step)

## [Shutter]

### Type

Electronically-controlled, vertical-traverse, focal-plane type

### Speed range

Still images: 1/8 000 second to 30 seconds, BULB

Movies: 1/8 000 second to 1/4 second (1/3 EV step)





- 1080 60i-compatible devices (1080 50i-compatible devices): up to 1/60 (1/50) second in AUTO mode (up to 1/30 (1/25) second in Auto slow shutter mode)

### Flash sync speed

1/250 second (when using a flash manufactured by Sony)

## [Continuous shooting]

### Continuous shooting speed

 : Maximum of approx. 10 images per second /  : Maximum of approx. 8 images per second /  : Maximum of approx. 6 images per second /  : Maximum of approx. 3 images per second

- Based on our measurement conditions. The speed of continuous shooting can be slower, depending on the shooting conditions.

## [Recording format]

### File format

JPEG (DCF Ver. 2.0, Exif Ver. 2.31, MPF Baseline) compliant, RAW (Sony ARW 2.3 format)

### Movie (XAVC S format)

MPEG-4 AVC/H.264 XAVC S ver.1.0 format compliant

Video: MPEG-4 AVC/H.264

Audio: LPCM 2ch (48kHz 16bit)

### Movie (AVCHD format)

AVCHD format Ver. 2.0 compatible

Video: MPEG-4 AVC/H.264

Audio: Dolby Digital 2ch, equipped with Dolby Digital Stereo Creator

- Manufactured under license from Dolby Laboratories.

## [Recording media]

Memory Stick, SD cards

## [Slot]

### SLOT 1

Slot for SD cards (UHS-I and UHS-II compatible)

### SLOT 2

Multi-slot for Memory Stick PRO Duo and SD cards (UHS-I compatible)

Supports operations between two memory cards.

## [Input/output terminals]

### USB Type-C terminal

SuperSpeed USB (USB 3.1 Gen 1)

### Multi/Micro USB Terminal\*

Hi-Speed USB (USB 2.0)

\* Supports Micro USB compatible devices.

### HDMI

HDMI type D micro jack

### (Microphone) terminal

∅ 3.5 mm Stereo mini jack

### (Headphones) terminal

∅ 3.5 mm Stereo mini jack

## [Power, general]

### Model No.

WW541200

### Rated input

7.2 V 

### Power consumption (while shooting)

Using an FE 28-70 mm F3.5-5.6 OSS

When using the viewfinder: Approx. 3.2 W

When using the monitor: Approx. 2.8 W

### Operating temperature

0 to 40°C (32 to 104°F)

### Storage temperature

-20 to 55°C (-4 to 131°F)

### Dimensions (W/H/D) (Approx.)

126.9 × 95.6 × 73.7 mm

126.9 × 95.6 × 62.7 mm (from grip to monitor)

5 × 3 7/8 × 3 in.

5 × 3 7/8 × 2 1/2 in. (from grip to monitor)

### Mass (CIPA compliant) (Approx.)

650 g (1 lb 7.0 oz) (including battery pack, SD card)

### Microphone

Stereo

### Speaker

Monaural

### Exif Print

Compatible

### DPOF

Compatible

### PRINT Image Matching III



Compatible

## **[Wireless LAN]**

### **Supported format**

IEEE 802.11 b/g/n

### **Frequency band**

2.4 GHz

### **Security**

WEP/WPA-PSK/WPA2-PSK

### **Connection method**

Wi-Fi Protected Setup™ (WPS)/Manual

### **Access method**

Infrastructure mode

## **[NFC]**

### **Tag type**

NFC Forum Type 3 Tag compliant

## **[Bluetooth communications]**

Bluetooth standard Ver. 4.1

### **Frequency band**

2.4 GHz

## **AC Adaptor AC-UUD12/AC-UUE12**

### **Rated input**

100 – 240 V  , 50/60 Hz, 0.2 A

### **Rated output**

5 V  , 1.5 A

## **Rechargeable battery pack NP-FZ100**

### **Rated voltage**

7.2 V 

## **Lens FE 28-70mm F3.5-5.6 OSS (supplied with ILCE-7M3K)**

### **Focal length**

28 mm – 70 mm

### **Lens groups – elements**

8 – 9

### **Angle of view**

75° – 34°

### **Minimum focus\***

0.3 m – 0.45 m (0.99 ft. – 1.48 ft.)

\* Minimum focus is the shortest distance from the image sensor to the subject.

### **Maximum magnification**

0.19×

### **Minimum aperture**

f/22 – f/36

### **Filter diameter**

55 mm

### **Dimensions (max. diameter × height)**

Approx. 72.5 mm × 83 mm (Approx. 2 7/8 inches × 3 3/8 inches)

### **Mass**

Approx. 295 g (Approx. 10.5 oz.)

**SteadyShot**

Available

Design and specifications are subject to change without notice.

4-732-947-11(1) Copyright 2018 Sony Corporation

## Trademarks

---

- Memory Stick and  are trademarks or registered trademarks of Sony Corporation.
- XAVC S and  are registered trademarks of Sony Corporation.
- AVCHD and AVCHD logotype are trademarks of Panasonic Corporation and Sony Corporation.
- Mac is a trademark of Apple Inc., registered in the United States and other countries.
- IOS is a registered trademark or trademark of Cisco Systems Inc.
- iPhone and iPad are trademarks of Apple Inc., registered in the U.S. and other countries.
- Blu-ray Disc™ and Blu-ray™ are trademarks of the Blu-ray Disc Association.
- DLNA and DLNA CERTIFIED are trademarks of Digital Living Network Alliance.
- USB Type-C™ and USB-C™ are trademarks of USB Implementers Forum.
- USB-IF SuperSpeed USB Trident logo is a registered trademark of USB Implementers Forum, Inc. ®
- Dolby, Dolby Audio and double-D symbol are trademarks of Dolby Laboratories.
- The terms HDMI and HDMI High-Definition Multimedia Interface, and the HDMI Logo are trademarks or registered trademarks of HDMI Licensing Administrator, Inc. in the United States and other countries.
- Microsoft and Windows are registered trademarks or trademarks of Microsoft Corporation in the United States and/or other countries.
- SDXC logo is a trademark of SD-3C, LLC.
- Facebook and the “f” logo are trademarks or registered trademarks of Facebook, Inc.
- Android and Google Play are trademarks or registered trademarks of Google Inc.
- YouTube and the YouTube logo are trademarks or registered trademarks of Google Inc.
- Wi-Fi, the Wi-Fi logo and Wi-Fi Protected Setup are registered trademarks or trademarks of the Wi-Fi Alliance.
- The N Mark is a trademark or registered trademark of NFC Forum, Inc. in the United States and in other countries.
- The Bluetooth® word mark and logos are registered trademarks owned by the Bluetooth SIG, Inc. and any use of such marks by Sony Corporation is under license.
- QR code is a trademark of Denso Wave Inc.
- In addition, system and product names used in this manual are, in general, trademarks or registered trademarks of their respective developers or manufacturers. However, the ™ or ® marks may not be used in all cases in this manual.

## List of default setting values





















The following are the default setting values.













### To reset settings to the default values

Select MENU →  (Setup) → [Setting Reset] → [Camera Settings Reset] or [Initialize] → [Enter].

The items that can be reset using [Camera Settings Reset] are limited. See the following tables. If you select [Initialize], all the settings of the camera will be reset to the default values.





















#### 1 Camera Settings1

MENU items	Default setting value	Resettable using [Camera Settings Reset]
 File Format	JPEG	✓
 RAW File Type	Compressed	✓
 JPEG Quality	Fine	✓
 JPEG Image Size (when [  Aspect Ratio] is set to [3:2])	L: 24M	✓
 JPEG Image Size (when [  Aspect Ratio] is set to [16:9])	L: 20M	✓
 JPEG Image Size (when [  Aspect Ratio] is set to [3:2] recording in the APS-C-equivalent size)	L: 10M	✓
 JPEG Image Size (when [  Aspect Ratio] is set to [16:9] recording in the APS-C-equivalent size)	L: 8.7M	✓
 Aspect Ratio	3:2	✓
APS-C/Super 35mm (  Shooting)	Auto	—
APS-C/Super 35mm (  Shoot.: Manual)	Off	—
 Long Exposure NR	On	✓
 High ISO NR	Normal	✓
 Color Space	sRGB	✓
Lens Comp. (Shading Comp.)	Auto	—
Lens Comp. (Chro. Aber. Comp.)	Auto	—
Lens Comp. (Distortion Comp.)	Off	—
Scene Selection	Portrait	✓
Drive Mode	Single Shooting	✓
Bracket Settings (Selftimer during Brkt)	Off	✓
Bracket Settings (Bracket order)	0→→→+	—
  1/  2 Recall	—	—





























MENU items	Default setting value	Resettable using [Camera Settings Reset]
  /  Memory	—	—
 Select Media	Slot 1	✓
Reg Cust Shoot Set	—	—
Focus Mode	Automatic AF	✓
Priority Set in AF-S	Balanced Emphasis	—
Priority Set in AF-C	Balanced Emphasis	—
Focus Area	Wide	✓
Focus Settings	—	✓
 Swt. V/H AF Area	Off	✓
 AF Illuminator	Auto	✓
Center Lock-on AF	Off	✓
Set. Face Prty in AF (Face Priority in AF)	On	✓
Set. Face Prty in AF (Face Dtct Frame Dsp)	Off	✓
 AF Track Sens	3(Standard)	✓
 AF System	Phase Detection AF	—
 AF w/ shutter	On	—
 Pre-AF	Off	—
 Eye-Start AF	Off	—
 AF Area Regist.	Off	—
 Del. Reg. AF Area	—	—
AF Area Auto Clear	Off	—
Disp. cont. AF area	On	—
AF Micro Adj.* (AF Adjustment Set.) * This item is not reset even if you select [Camera Settings Reset] or [Initialize].	Off	—
AF Micro Adj.* (Clear) * This item is not reset even if you select [Camera Settings Reset] or [Initialize].	—	—
AF Micro Adj.* (amount) * This item is not reset even if you select [Camera Settings Reset] or [Initialize].	±0	—
Exposure Comp.	±0.0	✓

MENU items	Default setting value	Resettable using [Camera Settings Reset]
Reset EV Comp.	Reset	—
ISO	ISO AUTO	✓
ISO AUTO Min. SS	Standard	✓
Metering Mode	Multi	✓
Face Prty in Mlti Mtr	On	✓
Spot Metering Point	Center	✓
Exposure step	0.3EV	—
 AEL w/ shutter	Auto	—
Exposure Std. Adjust	±0.0	—
Flash Mode	Autoflash	✓
Flash Comp.	±0.0	✓
Exp.comp.set	Ambient&flash	—
Wireless Flash	Off	✓
Red Eye Reduction	Off	✓
White Balance	Auto	✓
Priority Set in AWB	Standard	✓
DRO/Auto HDR	D-Range Optimizer: Auto	✓
Creative Style	Standard	✓
Picture Effect	Off	✓
Picture Profile	Off	✓
Focus Magnifier	—	✓
Focus Magnif. Time	No Limit	—
 Initial Focus Mag.	x1.0	—
 AF in Focus Mag.	On	—
 MF Assist	On	—
Peaking Setting (Peaking Display)	Off	—
Peaking Setting (Peaking Level)	Mid	—
Peaking Setting (Peaking Color)	White	—
 Anti-flicker Shoot.	Off	✓
Face Registration	—	—
Regist. Faces Priority	On	✓

MENU items	Default setting value	Resettable using [Camera Settings Reset]
 Exposure Mode	Program Auto	✓
 Exposure Mode	Program Auto	✓
 File Format	XAVC S HD	✓
 Record Setting (when [  File Format] is set to [XAVC S 4K])	24p 60M/25p 60M	✓
 Record Setting (when [  File Format] is set to [XAVC S HD])	60p 50M/50p 50M	✓
 Record Setting (when [  File Format] is set to [AVCHD])	60i 17M(FH)/50i 17M(FH)	✓
 S&Q Settings (  Record Setting)	30p/25p	✓
 S&Q Settings (  Frame Rate)	120fps/100fps	✓
 Proxy Recording	Off	✓
 AF drive speed	Normal	✓
 AF Track Sens	Standard	✓
 Auto Slow Shut.	On	✓
Audio Recording	On	✓
Audio Rec Level	26	✓
Audio Level Display	On	—
Audio Out Timing	Live	✓
Wind Noise Reduct.	Off	✓
 Marker Display	Off	—
 Marker Settings (Center)	Off	—
 Marker Settings (Aspect)	Off	—
 Marker Settings (Safety Zone)	Off	—
 Marker Settings (Guideframe)	Off	—
Video Light Mode	Power Link	—
Movie w/ shutter	Off	—
 Silent Shooting	Off	✓
e-Front Curtain Shut.	On	—
Release w/o Lens	Enable	—
Release w/o Card	Enable	—
SteadyShot	On	✓
SteadyShot Settings (SteadyShot Adjust.)	Auto	✓
SteadyShot Settings (SteadyS. Focal Len.) (when [SteadyShot Adjust.] is set to [Manual])	8mm	✓

MENU items	Default setting value	Resettable using [Camera Settings Reset]
Zoom	—	—
Zoom Setting	Optical zoom only	—
Zoom Ring Rotate	Left(W)/Right(T)	—
DISP Button (Monitor)	Display All Info.	—
DISP Button (Finder)	Level	—
FINDER/MONITOR	Auto	—
Zebra Setting (Zebra Display)	Off	—
Zebra Setting (Zebra Level)	70	—
Grid Line	Off	—
Exposure Set. Guide	Off	—
Live View Display	Setting Effect ON	—
Cont. Shoot. Length	Not Displayed	—
Auto Review	Off	—
 Custom Key (Control Wheel)	Not set	—
 Custom Key (Custom Button 1)	White Balance	—
 Custom Key (Custom Button 2)	Focus Area	—
 Custom Key (Custom Button 3)	Focus Mode	—
 Custom Key (Custom Button 4)	Touch Operation Sel.	—
 Custom Key (Multi-Slc Center Btn)	Focus Standard	—
 Custom Key (Center Button)	Eye AF	—
 Custom Key (Left Button)	Drive Mode	—
 Custom Key (Right Button)	ISO	—
 Custom Key (Down Button)	Not set	—
 Custom Key (AEL Button)	AEL hold	—
 Custom Key (AF-ON Button)	AF On	—
 Custom Key (Focus Hold Button)	Focus Hold	—
 Custom Key (Control Wheel)	Follow Custom (  )	—
 Custom Key (Custom Button 1)	Follow Custom (  )	—
 Custom Key (Custom Button 2)	Follow Custom (  )	—
 Custom Key (Custom Button 3)	Follow Custom (  )	—



MENU items	Default setting value	Resettable using [Camera Settings Reset]
 Custom Key (Custom Button 4)	Follow Custom (  )	—
 Custom Key (Multi-Slc Center Btn)	Follow Custom (  )	—
 Custom Key (Center Button)	Follow Custom (  )	—
 Custom Key (Left Button)	Follow Custom (  )	—
 Custom Key (Right Button)	Follow Custom (  )	—
 Custom Key (Down Button)	Follow Custom (  )	—
 Custom Key (AEL Button)	Follow Custom (  )	—
 Custom Key (AF-ON Button)	Follow Custom (  )	—
 Custom Key (Focus Hold Button)	Follow Custom (  )	—
 Custom Key (Custom Button 1)	Flw. Cust. (  /  )	—
 Custom Key (Custom Button 2)	Flw. Cust. (  /  )	—
 Custom Key (Custom Button 3)	Protect	—
 Custom Key (Fn/  Button)	Send to Smartphone	—
Function Menu Set.	—	—
Dial Setup	 Av  Tv	—
Av/Tv Rotate	Normal	—
Dial Ev Comp	Off	—
MOVIE Button	Always	—
Lock Operation Parts	Off	—
Audio signals	On	—

## Network

To reset the items for [Network] to the default values, select [Initialize] or [Reset Network Set.]. These items are not reset to the default values even if you select [Camera Settings Reset].

MENU items	Default setting value
Snd to Smrtphn Func (Send to Smartphone)	—
Snd to Smrtphn Func (  Sending Target)	Proxy Only

MENU items	Default setting value
Send to Computer	—
FTP Transfer Func. (FTP Transfer)	—
FTP Transfer Func. (Display FTP Result)	—
FTP Transfer Func. (Select FTP Server)	FTP Server 1
FTP Transfer Func. (FTP Server 1)	—
FTP Transfer Func. (FTP Server 2)	—
FTP Transfer Func. (FTP Server 3)	—
View on TV	—
Ctrl w/ Smartphone (Ctrl w/ Smartphone)	Off
Ctrl w/ Smartphone ( <input type="checkbox"/> Connection)	—
Ctrl w/ Smartphone (Always Connected)	Off
Airplane Mode	Off
Wi-Fi Settings (WPS Push)	—
Wi-Fi Settings (Access Point Set.)	—
Wi-Fi Settings (Disp MAC Address)	—
Wi-Fi Settings (SSID/PW Reset)	—
Bluetooth Settings (Bluetooth Function)	Off
Bluetooth Settings (Pairing)	—
Bluetooth Settings (Disp Device Address)	—
<input type="checkbox"/> Loc. Info. Link Set. (Location Info. Link)	Off
<input type="checkbox"/> Loc. Info. Link Set. (Auto Time Correct.) (when [Location Info. Link] is set to [On])	On
<input type="checkbox"/> Loc. Info. Link Set. (Auto Area Adjust.) (when [Location Info. Link] is set to [On])	On
Edit Device Name	—
Imp Root Certificate	—
Reset Network Set.	—

## Playback

To reset the items for [Playback] to the default values, select [Initialize]. These items are not reset to the default values even if you select [Camera Settings Reset].







MENU items	Default setting value
Protect	—
Rotate	—
Delete	—
Rating	—

MENU items	Default setting value
Rating Set(Cust Key)	—
Specify Printing	—
Copy	—
Photo Capture	—
⊕ Enlarge Image	—
⊕ Enlarge Init. Mag.	Standard. Mag.
⊕ Enlarge Initial Pos.	Focused Position
Slide Show (Repeat)	Off
Slide Show (Interval)	3 Sec
Select PB Media	Slot 1
View Mode	Date View
Image Index	9 Images
Disp Cont Shoot Grp	Off
Display Rotation	Auto
Image Jump Setting (Select Dial)	Front Dial
Image Jump Setting (Image Jump Method)	One by one

## Setup

To reset the items for [Setup] to the default values, select [Initialize]. These items are not reset to the default values even if you select [Camera Settings Reset].

MENU items	Default setting value
Monitor Brightness	Manual
Viewfinder Bright.	Auto
Finder Color Temp.	±0
Gamma Disp. Assist	Off
Volume Settings	7
Delete confirm.	"Cancel" first
Display Quality	Standard
Pwr Save Start Time	1 Min
Auto Pwr OFF Temp.	Standard
NTSC/PAL Selector	—
Cleaning Mode	—
Touch Operation	Off
Touch Panel/Pad	Touch Panel Only

MENU items	Default setting value
Touch Pad Settings (Operation in V Orien.)	On
Touch Pad Settings (Touch Pos. Mode)	Absolute Position
Touch Pad Settings (Operation Area)	 Right 1/2
Demo Mode	Off
TC/UB Settings (TC/UB Disp. Setting)	Counter
TC/UB Settings (TC Preset)	—
TC/UB Settings (UB Preset)	—
TC/UB Settings (TC Format)	DF
TC/UB Settings (TC Run)	Rec Run
TC/UB Settings (TC Make)	Preset
TC/UB Settings (UB Time Rec)	Off
Remote Ctrl	Off
HDMI Settings (HDMI Resolution)	Auto
HDMI Settings (  24p/60p Output)	60p
HDMI Settings (HDMI Info. Display)	On
HDMI Settings (  TC Output)	Off
HDMI Settings (  REC Control)	Off
HDMI Settings (CTRL FOR HDMI)	On
 4K Output Sel.	Memory Card+HDMI
USB Connection	Auto
USB LUN Setting	Multi
USB Power Supply	On
PC Remote Settings (Still Img. Save Dest.)	PC Only
PC Remote Settings (RAW+J PC Save Img)	RAW & JPEG
 Language	—
Date/Time Setup	—
Area Setting	—
Copyright Info (Write Copyright Info)	Off
Copyright Info (Set Photographer)	—
Copyright Info (Set Copyright)	—
Copyright Info (Disp. Copyright Info)	—
Format	—
File Number	Series

MENU items	Default setting value
Set File Name	DSC
Rec. Media Settings (Prioritize Rec. Media)	Slot 1
Rec. Media Settings (Recording Mode)	Standard
Rec. Media Settings (Auto Switch Media)	Off
Select REC Folder	—
New Folder	—
Folder Name	Standard Form
Recover Image DB* * This is not performed even when you select [Camera Settings Reset] or [Initialize].	—
Display Media Info.	—
Version	—
Setting Reset	—

### ★ My Menu

To reset the items for [My Menu] to the default values, select [Initialize] or [Delete All]. These items are not reset to the default values even if you select [Camera Settings Reset].

MENU items	Default setting value
Add Item	—
Sort Item	—
Delete Item	—
Delete Page	—
Delete All	—

Interchangeable Lens Digital Camera  
ILCE-7M3 α7III

## Troubleshooting

---

If you experience trouble with the product, try the following solutions.

- 1 Remove the battery pack, wait for about one minute, re-insert the battery pack, then turn on the power.**
  - 2 Initialize the settings.**
  - 3 Consult your dealer or local authorized service facility. Additional information on this product and answers to frequently asked questions can be found at our Customer Support Website.**  
<http://www.sony.net/>
- 

### Related Topic

- [Setting Reset](#)

Interchangeable Lens Digital Camera  
ILCE-7M3 α7III

## Warning messages

---

### Set Area/Date/Time.

- Set the area, date and time. If you have not used the product for a long time, charge the internal rechargeable backup battery.

### Power insufficient.

- The image copying or the image sensor cleaning function will not operate because the remaining battery level is too low. Recharge the battery pack or supply power using an AC Adaptor.

### Unable to use memory card. Format?

- The memory card was formatted on a computer and the file format was modified. Select [Enter] and then format the memory card. You can use the memory card again, however, all previous data in the memory card is erased. It may take some time to complete the format. If the message still appears, change the memory card.

### Memory Card Error

- An incompatible memory card is inserted.
- Formatting has failed. Format the memory card again.

### Unable to read memory card. Reinsert memory card.

- An incompatible memory card is inserted.
- The memory card is damaged.
- The terminal section of the memory card is dirty.

### Memory card locked.

- You are using a memory card with a write-protect switch or a delete-protect switch with the switch set to the LOCK position. Set the switch to the record position.

### Cannot open the shutter since the memory card is not inserted.

- No memory card has been inserted into the memory card slot selected in [Prioritize Rec. Media].
- To release the shutter without inserting a memory card into the camera, set [Release w/o Card] to [Enable]. In this case, images will not be saved.

### This memory card may not be capable of recording and playing normally.

- An incompatible memory card is inserted.

### Processing...

- When performing noise reduction, the reduction process takes place. You cannot do any further shooting during this reduction process.

### Unable to display.

- Images recorded with other products or images modified with a computer may not be displayed.
- Processing on the computer such as deletion of the image files may cause inconsistencies in the image database files. Repair the image database files.

**Check that a lens is mounted. For an unsupported lens, set "Release w/o Lens" in the menu to "Enable".**

- The lens is not attached properly, or the lens is not attached. If the message appears when a lens is attached, reattach the lens. If the message appears frequently, check whether the contacts of the lens and product are clean or not.
- When attaching the product to an astronomical telescope or similar instrument, or using an unsupported lens, set [Release w/o Lens] to [Enable].

**Unable to print.**

- You tried to mark RAW images with a DPOF mark.

**Internal temp. high. Allow it to cool.**

- The product has become hot because you have been shooting continuously. Turn the power off and cool the product and wait until the product is ready to shoot again.



- You have been recording images for a long time, the product temperature has risen.



- The number of images exceeds that for which date management in a database file by the product is possible.



- Unable to register to the database file. Import all the images to a computer using PlayMemories Home and recover the memory card.

**Image DataBase File error**

- There is something wrong in the Image Database File. Select [Setup] → [Recover Image DB].

**System Error**

**Camera Error. Turn power off then on.**

- Remove the battery pack, and then re-insert it. If the message appears frequently, consult local authorized Sony service facility.

**Image Database File error. Recover?**

- You cannot record and play back an AVCHD movie because the Image Database File is damaged. Recover the Image Database File following the on-screen instructions.

**Unable to magnify.**

**Unable to rotate image.**

- Images recorded with other products may not be enlarged or rotated.

**Cannot create more folders.**

- A folder in the memory card has the first three digits "999." You cannot create any more folders on this camera.

---

**Related Topic**

- [Notes on memory card](#)
- [Format](#)
- [Release w/o Lens](#)







Interchangeable Lens Digital Camera  
ILCE-7M3 α7III

## Recommended pages

---

-  **Auto Switch Media**  
If you use two memory-card slots, you can automatically switch to recording with the other memory card when the memory card in use becomes full.
-  **How to tag the location information on the images**  
You can record the location information on the images. The location information can be acquired via a smartphone.
-  **ILCE-7M3 Lens compatibility information**  
This website provides the lens compatibility information. (Another window will open.)